



LED TV

Chassis : U71A

U71B

Model : UE32EH5****

UE22ES5****

UE37EH5****

UE19ES4****

UE40EH5****

UE46EH5****

UE26EH4****

UE32EH4****

SERVICE Manual

LED TV



UE**ES4****/UE**EH4****
UE**ES5****/UE**EH5****

Contents

1. Precautions
2. Product specifications
3. Disassembly and Reassembly
4. Troubleshooting
5. Wiring Diagram

Contents

1. Precautions	1-1
1-1. Safety Precautions	1-1
1-2. Servicing Precautions	1-3
1-3. Static Electricity Precautions	1-4
1-4. Installation Precautions	1-5
2. Product Specifications	2-1
2-1. Product Information	2-1
2-2. Detail Factory Option	2-26
2-3. Accessories	2-28
3. Disassembly and Reassembly	3-1
3-1. Disassembly and Reassembly	3-1
3-2. Assy Board P-Jog Switch & Ir	3-13
3-3. Disassembly(PTC)	3-15
4. Troubleshooting	4-1
4-1. Troubleshooting	4-1
4-2. How to Check Fault Symptom	4-5
4-3. Factory Mode Adjustments	4-8
4-4. White Balance	4-17
4-5. White Ratio (Balance) Adjustment	4-20
4-6. RS-232C	4-21
4-7. Software Upgrade	4-22
4-8. Cover-Middle Rear Dimension	4-24
5. Wiring Diagram	5-1
5-1. Wiring Diagram	5-1
5-2. Connector	5-3
5-3. Connector Functions	5-5
5-4. Cables	5-6



**This Service Manual is a property of Samsung Electronics Co.,Ltd.
Any unauthorized use of Manual can be punished under applicable
International and/or domestic law.**

**© 2012 Samsung Electronics Co.,Ltd.
All rights reserved.
Printed in Korea**

1. Precautions

1-1. Safety Precautions

Follow these safety, servicing and ESD precautions to prevent damage and to protect against potential hazards such as electrical shock.

1-1-1. Warnings



For continued safety, do not attempt to modify the circuit board.
Disconnect the AC power and DC power jack before servicing.

1-1-2. Servicing the LED TV

1. When servicing the LED TV, Disconnect the AC line cord from the AC outlet.
2. It is essential that service technicians have an accurate voltage meter available at all times. Check the calibration of this meter periodically.

1-1-3. Fire and Shock Hazard

Before returning the monitor to the user, perform the following safety checks:

1. Inspect each lead dress to make certain that the leads are not pinched or that hardware is not lodged between the chassis and other metal parts in the monitor.
2. Inspect all protective devices such as nonmetallic control knobs, insulating materials, cabinet backs, adjustment and compartment covers or shields, isolation resistor/capacitor networks, mechanical insulators, etc.
3. Leakage Current Hot Check:

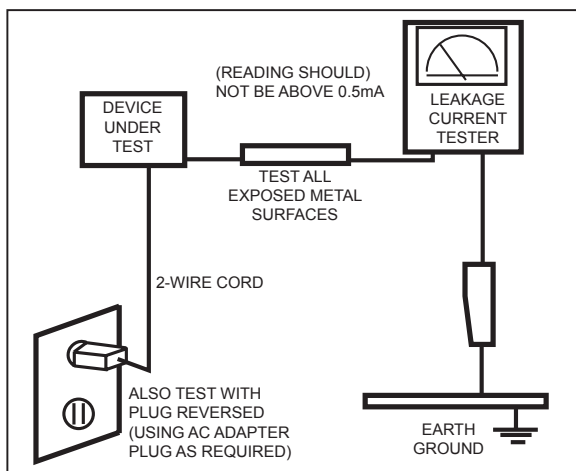

Do not use an isolation transformer during this test.

Use a leakage current tester or a metering system that complies with American National Standards Institute (ANSI C101.1, Leakage Current for Appliances), and Underwriters Laboratories (UL Publication UL1410, 59.7).

4. With the unit completely reassembled, plug the AC line cord directly into a 120V AC outlet. With the unit's AC switch first in the ON position and then OFF, measure the current between a known earth ground (metal water pipe, conduit, etc.) and all exposed metal parts, including: metal cabinets, screwheads and control shafts. The current measured should not exceed 0.5 milliamp. Reverse the power-plug prongs in the AC outlet and repeat the test.

1-1-4. Product Safety Notices

Some electrical and mechanical parts have special safety-related characteristics which are often not evident from visual inspection. The protection they give may not be obtained by replacing them with components rated for higher voltage, wattage, etc. Parts that have special safety characteristics are identified by  on schematics and parts lists. A substitute replacement that does not have the same safety characteristics as the recommended replacement part might create shock, fire and/or other hazards. Product safety is under review continuously and new instructions are issued whenever appropriate.

1-2. Servicing Precautions



An electrolytic capacitor installed with the wrong polarity might explode.



Before servicing units covered by this service manual, read and follow the Safety Precautions section of this manual.



If unforeseen circumstances create conflict between the following servicing precautions and any of the safety precautions, always follow the safety precautions.

1-2-1. General Servicing Precautions

1. Always unplug the unit's AC power cord from the AC power source and disconnect the DC Power Jack before attempting to: (a) remove or reinstall any component or assembly, (b) disconnect PCB plugs or connectors, (c) connect a test component in parallel with an electrolytic capacitor.
2. Some components are raised above the printed circuit board for safety. An insulation tube or tape is sometimes used. The internal wiring is sometimes clamped to prevent contact with thermally hot components. Reinstall all such elements to their original position.
3. After servicing, always check that the screws, components and wiring have been correctly reinstalled. Make sure that the area around the serviced part has not been damaged.
4. Check the insulation between the blades of the AC plug and accessible conductive parts (examples: metal panels, input terminals and earphone jacks).
5. Insulation Checking Procedure: Disconnect the power cord from the AC source and turn the power switch ON. Connect an insulation resistance meter (500 V) to the blades of the AC plug. The insulation resistance between each blade of the AC plug and accessible conductive parts (see above) should be greater than 1 megohm.
6. Always connect a test instrument's ground lead to the instrument chassis ground before connecting the positive lead; always remove the instrument's ground lead last.

1-3. Static Electricity Precautions

Some semiconductor (solid state) devices can be easily damaged by static electricity. Such components are commonly called Electrostatically Sensitive Devices (ESD). Examples of typical ESD are integrated circuits and some field-effect transistors. The following techniques will reduce the incidence of component damage caused by static electricity.

1. Immediately before handling any semiconductor components or assemblies, drain the electrostatic charge from your body by touching a known earth ground. Alternatively, wear a discharging wrist-strap device. To avoid a shock hazard, be sure to remove the wrist strap before applying power to the monitor.
2. After removing an ESD-equipped assembly, place it on a conductive surface such as aluminum foil to prevent accumulation of an electrostatic charge.
3. Do not use freon-propelled chemicals. These can generate electrical charges sufficient to damage ESDs.
4. Use only a grounded-tip soldering iron to solder or desolder ESDs.
5. Use only an anti-static solder removal device. Some solder removal devices not classified as "anti-static" can generate electrical charges sufficient to damage ESDs.
6. Do not remove a replacement ESD from its protective package until you are ready to install it. Most replacement ESDs are packaged with leads that are electrically shorted together by conductive foam, aluminum foil or other conductive materials.
7. Immediately before removing the protective material from the leads of a replacement ESD, touch the protective material to the chassis or circuit assembly into which the device will be installed.



Be sure no power is applied to the chassis or circuit and observe all other safety precautions.

CAUTION

8. Minimize body motions when handling unpackaged replacement ESDs. Motions such as brushing clothes together, or lifting your foot from a carpeted floor can generate enough static electricity to damage an ESD.

1-4. Installation Precautions

1. For safety reasons, more than a people are required for carrying the product.
2. Keep the power cord away from any heat emitting devices, as a melted covering may cause fire or electric shock.
3. Do not place the product in areas with poor ventilation such as a bookshelf or closet. The increased internal temperature may cause fire.
4. Bend the external antenna cable when connecting it to the product. This is a measure to protect it from being exposed to moisture. Otherwise, it may cause a fire or electric shock.
5. Make sure to turn the power off and unplug the power cord from the outlet before repositioning the product. Also check the antenna cable or the external connectors if they are fully unplugged. Damage to the cord may cause fire or electric shock.
6. Keep the antenna far away from any high-voltage cables and install it firmly. Contact with the highvoltage cable or the antenna falling over may cause fire or electric shock.
7. When installing the product, leave enough space (0.4m) between the product and the wall for ventilation purposes. A rise in temperature within the product may cause fire.

2. Product Specifications



2-1. Product Information

2-1-1. Model Comparison



Model	UE**EH5****		
Front View	<p style="text-align: center;">* W : Width H : High D : Depth</p>		
Detail View			
Front Color	Black (Panel)		
Dimensions (W x H x D)	32"	Set with Stand	738.3 x 498.1 x 191.6 mm / 29.1 x 19.6 x 7.5 inches
		Set without Stand	738.3 x 444.6 x 93.1 mm / 29.1 x 17.5 x 3.7 inches
	37"	Set with Stand	866.5 x 575.5 x 247.8 mm / 34.1 x 22.7 x 9.8 inches
		Set without Stand	866.5 x 519.2 x 93.0 mm / 34.1 x 20.4 x 3.7 inches
	40"	Set with Stand	927.6 x 606.4 x 227.6 mm / 36.5 x 19.6 x 7.5 inches
		Set without Stand	927.6 x 551.0 x 93.0 mm / 36.5 x 17.5 x 3.7 inches
	46"	Set with Stand	1059.8 x 680.7 x 227.6 mm / 41.7 x 26.8 x 9.0 inches
		Set without Stand	1059.8 x 625.6 x 94.3 mm / 41.7 x 24.6 x 3.7 inches



2. Product specifications

Weight	32"	Set with Stand	6.4 kg / 14.11 lbs
		Set without Stand	5.7 kg / 12.57 lbs
	37"	Set with Stand	9.9 kg / 21.83 lbs
		Set without Stand	8.0 kg / 17.64 lbs
	40"	Set with Stand	11.0 kg / 24.25 lbs
		Set without Stand	9.0 kg / 19.84 lbs
	46"	Set with Stand	14.0 kg / 30.86 lbs
		Set without Stand	12.0 kg / 26.46 lbs
Panel Type	Anti Glare		
Internal Memory	None		
DDR	128 Mbyte		
Feature	Media Play(Movie)		

Model	UE**EH4****		
Front View	 <p style="text-align: center;">* W : Width H : High D : Depth</p>		
Detail View			
Front Color	Black (Panel)		
Dimensions (W x H x D)	26"	Set with Stand	615.1 x 419.2 x 180.7 mm / 24.2 x 16.5 x 7.7 inches
		Set without Stand	615.1 x 365.6 x 93.3 mm / 24.2 x 14.4 x 3.7 inches
	32"	Set with Stand	738.8 x 498.1 x 191.6 mm / 29.1 x 19.4 x 7.5 inches
		Set without Stand	738.8 x 444.6 x 93.1 mm / 29.1 x 17.2 x 3.7 inches
Weight	26"	Set with Stand	4.5 kg / 9.92 lbs
		Set without Stand	4.0 kg / 8.82 lbs
	32"	Set with Stand	6.3 kg / 13.89 lbs
		Set without Stand	5.7 kg / 12.57 lbs
Panel Type	Anti Glare		
Internal Memory	None		
DDR	128 Mbyte		
Feature	Media Play(Movie)		

2. Product specifications

Model	UE22ES5****		
Front View	 <p style="text-align: center;">* W : Width H : High D : Depth</p>		
Detail View			
Front Color	Black (Panel)		
Dimensions (W x H x D)	22"	Set with Stand	513.4 x 364.4 x 161.0 mm / 20.2 x 14.3 x 6.3 inches
		Set without Stand	513.4 x 316.2 x 49.6 mm / 20.2 x 12.4 x 2.0 inches
Weight	22"	Set with Stand	3.5 kg / 7.72 lbs
		Set without Stand	3.3 kg / 7.28 lbs
Panel Type	Anti Glare		
Internal Memory	None		
DDR	128 Mbyte\		
Feature	Media Play(Movie)		

Model	UE19ES4****		
Front View	 <p style="text-align: center;">* W : Width H : High D : Depth</p>		
Detail View			
Front Color	Black (Panel)		
Dimensions (W x H x D)	19"	Set with Stand	446.8 x 326.9 x 161.0 mm / 17.6 x 12.9 x 6.3 inches
Weight	19"	Set without Stand	446.8 x 278.7 x 49.6 mm / 17.6 x 11.0 x 2.0 inches
Panel Type	Anti Glare		
Internal Memory	None		
DDR	128 Mbyte		
Feature	Media Play(Movie)		

2-1-2. Feature & Specifications

Model	UE32EH5****	
Feature		
<ul style="list-style-type: none"> • Digital-TV, RF, 2-HDMI, 1-Component, 1-A/V, 1-USB2.0 • High Contrast Ratio : MEGA • Response Time : 8 ms • CMR : 100 		
Specifications		
Item	Description	
LCD Panel	32 inch FHD 60Hz	
Scanning Frequency	Horizontal : 60 kHz ~ 73 kHz (Automatic) Vertical : 47 Hz ~ 63 Hz (Automatic)	
Display Colors	16.7M colors	
Maximum Resolution	Horizontal : 1920 Pixels Vertical : 1080 Pixels	
Input Signal	Analog 0.7 Vp-p \pm 5% positive at 75 Ω , internally terminated	
Input Sync Signal	H/V Separate, TTL, P. or N.	
Maximum Pixel Clock Rate	74.25 MHz	
Active Display (H x V)* * Horizontal x Vertical	703.4(H) X 397.8(V) (mm) / 28.7(H) X 16.2(V) (inches)	
AC Power Voltage & Frequency	AC 220V ~ 240V, 50/60 Hz (Europe area) AC 100V ~ 240V, 50/60 Hz (CIS area)	
Power Consumption	60 W (Under 0.3 W, Stand by) Europe area 62 W (Under 0.3 W, Stand by) CIS area	
Dimensions Set (W x H x D)* * Width x High x Depth	Set with Stand	738.3 x 498.1 x 191.6 mm / 29.1 x 19.6 x 7.5 inches
	Set without Stand	738.3 x 444.6 x 93.1 mm / 29.1 x 17.5 x 3.7 inches
Weight	Set with Stand	6.4 kg / 14.11 lbs
	Set without Stand	5.7 kg / 12.57 lbs
TV System	TV	Analogue :B/G, D/K, L, I(Depending on your country selection) Digital: DVB-T/DVB-C *UK, Nordic, Russia, UKR Area : DVB-T2/DVB-C *Russia, UKR Area Model Code: UE32EH50*7KXR(UA)
	Colour Video	Analogue: PAL, SECAM, NTSC-4.43, NTSC-3.58, PAL60 Digital: MPEG-2 MP@ML, MPEG-4, H.264/AVC MP@L3 MP@L4.0, HP@L4.0
	Sound	BG, DK, L, NICAM, MPEG1, DD, DD+, HEAAC

Specifications	
Item	Description
Environmental Considerations	Operating Temperature : 32°F ~ 122°F (0°C ~ 50°C) Operating Humidity : 20% ~ 90% Storage Temperature : -4°F ~ 140°F (-20°C ~ 60°C) Storage Humidity : 10% ~ 90%
Audio Specifications	MAX Internal Audio Output Power : Each 10 W(Left/Right) Equalizer : 5 Band Output Frequency : <ul style="list-style-type: none">• RF : 20 Hz ~ 15.4 kHz• AV/Componet/HDMI : 20 Hz ~ 20 kHz
Note : Dolby Digital Plus/Pulse, USB2.0, Film mode, Energy Saving, Eco sensor	

2. Product specifications

Model	UE37EH5****	
Feature		
<ul style="list-style-type: none"> Digital-TV, RF, 2-HDMI, 1-Component, 1-A/V, 1-USB2.0 High Contrast Ratio : MEGA Response Time : 8 ms CMR : 100 		
Specifications		
Item	Description	
LCD Panel	37 inch FHD 60Hz	
Scanning Frequency	Horizontal : 60 kHz ~ 73 kHz (Automatic) Vertical : 47 Hz ~ 63 Hz (Automatic)	
Display Colors	16.7M colors	
Maximum Resolution	Horizontal : 1920 Pixels Vertical : 1080 Pixels	
Input Signal	Analog 0.7 Vp-p ± 5% positive at 75Ω, internally terminated	
Input Sync Signal	H/V Separate, TTL, P. or N.	
Maximum Pixel Clock Rate	74.25 MHz	
Active Display (H x V)* * Horizontal x Vertical	819.4(H) X 460.9(V) (mm) / 33.4(H) X 18.8(V) (inches)	
AC Power Voltage & Frequency	AC 220V ~ 240V, 50/60 Hz (Europe area) AC 100V ~ 240V, 50/60 Hz (CIS area)	
Power Consumption	79 W (Under 0.3 W, Stand by) Europe area 81 W (Under 0.3 W, Stand by) CIS area	
Dimensions Set (W x H x D)* * Width x High x Depth	Set with Stand	866.5 x 575.5 x 247.8 mm / 34.1 x 22.7 x 9.8 inches
	Set without Stand	738.3 x 519.2 x 93.0 mm / 34.1 x 20.4 x 3.7 inches
Weight	Set with Stand	9.9 kg / 21.83 lbs
	Set without Stand	8.0 kg / 17.64 lbs
TV System	TV	Analogue :B/G, D/K, L, I(Depending on your country selection) Digital: DVB-T/DVB-C * UK, Nordic, Russia, UKR Area : DVB-T2/DVB-C * Russia, UKR Area Model Code: UE37EH50*7KXRU(UA)
	Colour Video	Analogue: PAL, SECAM, NTSC-4.43, NTSC-3.58, PAL60 Digital: MPEG-2 MP@ML, MPEG-4, H.264/AVC MP@L3 MP@L4.0, HP@L4.0
	Sound	BG, DK, L, NICAM, MPEG1, DD, DD+, HEAAC

Specifications	
Item	Description
Environmental Considerations	Operating Temperature : 32°F ~ 122°F (0°C ~ 50°C) Operating Humidity : 20% ~ 90% Storage Temperature : -4°F ~ 140°F (-20°C ~ 60°C) Storage Humidity : 10% ~ 90%
Audio Specifications	MAX Internal Audio Output Power : Each 10 W(Left/Right) Equalizer : 5 Band Output Frequency : <ul style="list-style-type: none"> • RF : 20 Hz ~ 15.4 kHz • AV/Componet/HDMI : 20 Hz ~ 20 kHz
Note : Dolby Digital Plus/Pulse, USB2.0, Film mode, Energy Saving, Eco sensor	

2. Product specifications

Model	UE40EH5****	
Feature		
<ul style="list-style-type: none"> • Digital-TV, RF, 2-HDMI, 1-Component, 1-A/V, 1-USB2.0 • High Contrast Ratio : MEGA • Response Time : 8 ms • CMR : 100 		
Specifications		
Item	Description	
LCD Panel	40 inch FHD 60Hz	
Scanning Frequency	Horizontal : 60 kHz ~ 73 kHz (Automatic) Vertical : 47 Hz ~ 63 Hz (Automatic)	
Display Colors	16.7M colors	
Maximum Resolution	Horizontal : 1920 Pixels Vertical : 1080 Pixels	
Input Signal	Analog 0.7 Vp-p ± 5% positive at 75Ω, internally terminated	
Input Sync Signal	H/V Separate, TTL, P. or N.	
Maximum Pixel Clock Rate	74.25 MHz	
Active Display (H x V)* * Horizontal x Vertical	890.6(H) X 503.2(V) (mm) / 36.4(H) X 20.5(V) (inches)	
AC Power Voltage & Frequency	AC 220V ~ 240V, 50/60 Hz (Europe area) AC 100V ~ 240V, 50/60 Hz (CIS area)	
Power Consumption	87 W (Under 0.3 W, Stand by) Europe area, CIS area	
Dimensions Set (W x H x D)* * Width x High x Depth	Set with Stand	927.6 x 606.4 x 227.6 mm / 36.5 x 19.6 x 7.5 inches
	Set without Stand	927.6 x 551.0 x 93.0 mm / 36.5 x 17.5 x 3.7 inches
Weight	Set with Stand	11.0 kg / 24.25 lbs
	Set without Stand	9.0 kg / 19.84 lb
TV System	TV	Analogue :B/G, D/K, L, I(Depending on your country selection) Digital: DVB-T/DVB-C * UK, Nordic, Russia, UKR Area : DVB-T2/DVB-C * Russia, UKR Area Model Code: UE40EH50*7KXRU(UA)
	Colour Video	Analogue: PAL, SECAM, NTSC-4.43, NTSC-3.58, PAL60 Digital: MPEG-2 MP@ML, MPEG-4, H.264/AVC MP@L3 MP@L4.0, HP@L4.0
	Sound	BG, DK, L, NICAM, MPEG1, DD, DD+, HEAAC

Specifications	
Item	Description
Environmental Considerations	Operating Temperature : 32°F ~ 122°F (0°C ~ 50°C) Operating Humidity : 20% ~ 90% Storage Temperature : -4°F ~ 140°F (-20°C ~ 60°C) Storage Humidity : 10% ~ 90%
Audio Specifications	MAX Internal Audio Output Power : Each 10 W(Left/Right) Equalizer : 5 Band Output Frequency : <ul style="list-style-type: none"> • RF : 20 Hz ~ 15.4 kHz • AV/Componet/HDMI : 20 Hz ~ 20 kHz
Note : Dolby Digital Plus/Pulse, USB2.0, Film mode, Energy Saving, Eco sensor	

2. Product specifications

Model	UE46EH5****	
Feature		
<ul style="list-style-type: none"> • Digital-TV, RF, 2-HDMI, 1-Component, 1-A/V, 1-USB2.0 • High Contrast Ratio : MEGA • Response Time : 8 ms • CMR : 100 		
Specifications		
Item	Description	
LCD Panel	46 inch FHD 60Hz	
Scanning Frequency	Horizontal : 60 kHz ~ 73 kHz (Automatic) Vertical : 47 Hz ~ 63 Hz (Automatic)	
Display Colors	16.7M colors	
Maximum Resolution	Horizontal : 1920 Pixels Vertical : 1080 Pixels	
Input Signal	Analog 0.7 Vp-p ± 5% positive at 75Ω, internally terminated	
Input Sync Signal	H/V Separate, TTL, P. or N.	
Maximum Pixel Clock Rate	74.25 MHz	
Active Display (H x V)* * Horizontal x Vertical	1023.0(H) X 577.6(V) (mm) / 41.8(H) X 23.6(V) (inches)	
AC Power Voltage & Frequency	AC 220V ~ 240V, 50/60 Hz (Europe area) AC 100V ~ 240V, 50/60 Hz (CIS area)	
Power Consumption	92 W (Under 0.3 W, Stand by) Europe area 95 W (Under 0.3 W, Stand by) CIS Area	
Dimensions Set (W x H x D)* * Width x High x Depth	Set with Stand	1059.8 x 680.7 x 227.6 mm / 41.7 x 26.8 x 9.0 inches
	Set without Stand	1059.8 x 625.6 x 94.3 mm / 41.7 x 24.6 x 3.7 inches
Weight	Set with Stand	14.0 kg / 30.86 lbs
	Set without Stand	12.0 kg / 26.46 lbs
TV System	TV	Analogue :B/G, D/K, L, I(Depending on your country selection) Digital: DVB-T/DVB-C * UK, Nordic, Russia, UKR Area : DVB-T2/DVB-C * Russia, UKR Area Model Code: UE46EH50*7KXRU(UA)
	Colour Video	Analogue: PAL, SECAM, NTSC-4.43, NTSC-3.58, PAL60 Digital: MPEG-2 MP@ML, MPEG-4, H.264/AVC MP@L3 MP@L4.0, HP@L4.0
	Sound	BG, DK, L, NICAM, MPEG1, DD, DD+, HEAAC

Specifications	
Item	Description
Environmental Considerations	Operating Temperature : 32°F ~ 122°F (0°C ~ 50°C) Operating Humidity : 20% ~ 90% Storage Temperature : -4°F ~ 140°F (-20°C ~ 60°C) Storage Humidity : 10% ~ 90%
Audio Specifications	MAX Internal Audio Output Power : Each 10 W(Left/Right) Equalizer : 5 Band Output Frequency : <ul style="list-style-type: none"> • RF : 20 Hz ~ 15.4 kHz • AV/Componet/HDMI : 20 Hz ~ 20 kHz
Note : Dolby Digital Plus/Pulse, USB2.0, Film mode, Energy Saving, Eco sensor	

2. Product specifications

Model	UE26EH4****	
Feature		
<ul style="list-style-type: none"> • Digital-TV, RF, 1-HDMI, 1-Component, 1-A/V, 1-USB2.0 • High Contrast Ratio : MEGA • Response Time : 4 ms • CMR : 100 		
Specifications		
Item	Description	
LCD Panel	26 inch HD 60Hz	
Scanning Frequency	Horizontal : 60 kHz ~ 73 kHz (Automatic) Vertical : 47 Hz ~ 63 Hz (Automatic)	
Display Colors	16.7M colors	
Maximum Resolution	Horizontal : 1366 Pixels Vertical : 768 Pixels	
Input Signal	Analog 0.7 Vp-p ± 5% positive at 75Ω, internally terminated	
Input Sync Signal	H/V Separate, TTL, P. or N.	
Maximum Pixel Clock Rate	74.25 MHz	
Active Display (H x V)* * Horizontal x Vertical	580.8(H) x 328.7(V) mm/ 23.7(H) X 13.4(V) (inches)	
AC Power Voltage & Frequency	AC 220V ~ 240V, 50/60 Hz (Europe area) AC 100V ~ 240V, 50/60 Hz (CIS area)	
Power Consumption	40 W (Under 0.3 W, Stand by) Europe area 41 W (Under 0.3 W, Stand by) CIS area	
Dimensions Set (W x H x D)* * Width x High x Depth	Set with Stand	615.1 x 419.2 x 180.7 mm / 24.2 x 16.5 x 7.7 inches
	Set without Stand	615.1 x 365.6 x 93.3 mm / 24.2 x 14.4 x 3.7 inches
Weight	Set with Stand	4.5 kg / 9.92 lbs
	Set without Stand	4.0 kg / 8.82 lbs
TV System	TV	FAnalogue :B/G, D/K, L, I(Depending on your country selection) Digital: DVB-T/DVB-C
	Colour Video	Analogue: PAL, SECAM, NTSC-4.43, NTSC-3.58, PAL60 Digital: MPEG-2 MP@ML, MPEG-4, H.264/AVC MP@L3 MP@L4.0, HP@L4.0
	Sound	BG, DK, L, NICAM, MPEG1, DD, DD+, HEAAC

Specifications	
Item	Description
Environmental Considerations	Operating Temperature : 32°F ~ 122°F (0°C ~ 50°C) Operating Humidity : 20% ~ 90% Storage Temperature : -4°F ~ 140°F (-20°C ~ 60°C) Storage Humidity : 10% ~ 90%
Audio Specifications	MAX Internal Audio Output Power : Each 5 W(Left/Right) Equalizer : 5 Band Output Frequency : <ul style="list-style-type: none">• RF : 20 Hz ~ 15.4 kHz• AV/Componet/HDMI : 20 Hz ~ 20 kHz
Note : Dolby Digital Plus/Pulse, USB2.0, Film mode, Energy Saving	

2. Product specifications

Model	UE32EH4****	
Feature		
<ul style="list-style-type: none"> • Digital-TV, RF, 1-HDMI, 1-Component, 1-A/V, 1-USB2.0 • High Contrast Ratio : MEGA • Response Time : 4 ms • CMR : 100 		
Specifications		
Item	Description	
LCD Panel	32 inch HD 60Hz	
Scanning Frequency	Horizontal : 60 kHz ~ 73 kHz (Automatic) Vertical : 47 Hz ~ 63 Hz (Automatic)	
Display Colors	16.7M colors	
Maximum Resolution	Horizontal : 1366 Pixels Vertical : 768 Pixels	
Input Signal	Analog 0.7 Vp-p \pm 5% positive at 75 Ω , internally terminated	
Input Sync Signal	H/V Separate, TTL, P. or N.	
Maximum Pixel Clock Rate	74.25 MHz	
Active Display (H x V)* * Horizontal x Vertical	902.0(H) x 162.0(V) mm / 36.8(H) X 6.6(V) (inches)	
AC Power Voltage & Frequency	AAC 220V ~ 240V, 50/60 Hz (Europe area) AC 100V ~ 240V, 50/60 Hz (CIS area)	
Power Consumption	52 W (Under 0.3 W, Stand by) Europe area 54 W (Under 0.3 W, Stand by) CIS area	
Dimensions Set (W x H x D)* * Width x High x Depth	Set with Stand	738.8 x 493.3 x 191.7 mm / 29.1 x 19.4 x 7.5 inches
	Set without Stand	738.8 x 436.7 x 93.3 mm / 29.1 x 17.2 x 3.7 inches
Weight	Set with Stand	6.3 kg / 13.89 lbs
	Set without Stand	5.7 kg / 12.57 lbs
TV System	TV	Analogue :B/G, D/K, L, I(Depending on your country selection) Digital: DVB-T/DVB-C
	Colour Video	Analogue: PAL, SECAM, NTSC-4.43, NTSC-3.58, PAL60 Digital: MPEG-2 MP@ML, MPEG-4, H.264/AVC MP@L3 MP@L4.0, HP@L4.0
	Sound	BG, DK, L, NICAM, MPEG1, DD, DD+, HEAAC

Specifications	
Item	Description
Environmental Considerations	Operating Temperature : 32°F ~ 122°F (0°C ~ 50°C) Operating Humidity : 20% ~ 90% Storage Temperature : -4°F ~ 140°F (-20°C ~ 60°C) Storage Humidity : 10% ~ 90%
Audio Specifications	MAX Internal Audio Output Power : Each 10 W(Left/Right) Equalizer : 5 Band Output Frequency : <ul style="list-style-type: none"> • RF : 20 Hz ~ 15.4 kHz • AV/Componet/HDMI : 20 Hz ~ 20 kHz
Note : Dolby Digital Plus/Pulse, USB2.0, Film mode, Energy Saving	

2. Product specifications

Model	UE22ES5****	
Feature		
<ul style="list-style-type: none"> • Digital-TV, RF, 1-HDMI, 1-Component, 1-A/V, 1-USB2.0 • High Contrast Ratio : MEGA • Response Time : 8 ms • CMR : 100 		
Specifications		
Item	Description	
LCD Panel	22 inch FHD 60 Hz	
Scanning Frequency	Horizontal : 60 kHz ~ 73 kHz (Automatic) Vertical : 47 Hz ~ 63 Hz (Automatic)	
Display Colors	16.7M colors	
Maximum Resolution	Horizontal : 1920 Pixels Vertical : 1080 Pixels	
Input Signal	Analog 0.7 Vp-p \pm 5% positive at 75 Ω , internally terminated	
Input Sync Signal	H/V Separate, TTL, P. or N.	
Maximum Pixel Clock Rate	74.25 MHz	
Active Display (H x V)* * Horizontal x Vertical	503.4(H) x 397.8(V) mm / 20.5(H) x 16.2(V) inches	
AC Power Voltage & Frequency	AC 220V ~ 240V, 50/60 Hz (Europe area) AC 100V ~ 240V, 50/60 Hz (CIS area)	
Power Consumption	30 W (Under 0.3 W, Stand by) Europe area, CIS area	
Dimensions Set (W x H x D)* * Width x High x Depth	Set with Stand	513.4 x 364.4 x 161.0 mm / 20.2 x 14.3 x 6.3 inches
	Set without Stand	513.4 x 316.2 x 49.6 mm / 20.2 x 12.4 x 2.0 inches
Weight	Set with Stand	3.5 kg / 7.72 lbs
	Set without Stand	3.3 kg / 7.28 lbs
TV System	TV	Analogue :B/G, D/K, L, I(Depending on your country selection) Digital: DVB-T/DVB-C
	Colour Video	Analogue: PAL, SECAM, NTSC-4.43, NTSC-3.58, PAL60 Digital: MPEG-2 MP@ML, MPEG-4, H.264/AVC MP@L3 MP@L4.0, HP@L4.0
	Sound	BG, DK, L, NICAM, MPEG1, DD, DD+, HEAAC



Specifications	
Item	Description
Environmental Considerations	Operating Temperature : 32°F ~ 122°F (0°C ~ 50°C) Operating Humidity : 20% ~ 90% Storage Temperature : -4°F ~ 140°F (-20°C ~ 60°C) Storage Humidity : 10% ~ 90%
Audio Specifications	MAX Internal Audio Output Power : Each 3 W(Left/Right) Equalizer : 5 Band Output Frequency : <ul style="list-style-type: none">• RF : 20 Hz ~ 15.4 kHz• AV/Componet/HDMI : 20 Hz ~ 20 kHz
Note : Dolby Digital Plus/Pulse, USB2.0, Film mode, Energy Saving, Eco sensor	

2. Product specifications

Model	UE19ES4****	
Feature		
<ul style="list-style-type: none"> • Digital-TV, RF, 1-HDMI, 1-Component, 1-A/V, 1-USB2.0 • High Contrast Ratio : MEGA • Response Time : 4 ms • CMR : 100 		
Specifications		
Item	Description	
LCD Panel	19 inch HD 60 Hz	
Scanning Frequency	Horizontal : 60 kHz ~ 73 kHz (Automatic) Vertical : 47 Hz ~ 63 Hz (Automatic)	
Display Colors	16.7M colors	
Maximum Resolution	Horizontal : 1366 Pixels Vertical : 768 Pixels	
Input Signal	Analog 0.7 Vp-p ± 5% positive at 75Ω, internally terminated	
Input Sync Signal	H/V Separate, TTL, P. or N.	
Maximum Pixel Clock Rate	74.25 MHz	
Active Display (H x V)* * Horizontal x Vertical	350.0(H) x 150.0(V) mm / 14.3(H) X 6.1(V) (inches)	
AC Power Voltage & Frequency	AC 220V ~ 240V, 50/60 Hz (Europe area) AC 100V ~ 240V, 50/60 Hz (CIS area)	
Power Consumption	27 W (Under 0.3 W, Stand by) Europe area, CIS area	
Dimensions Set (W x H x D)* * Width x High x Depth	Set with Stand	446.8 x 326.9 x 161 mm / 17.6 x 12.9 x 6.3 inches
	Set without Stand	446.8 x 278.7 x 49.6 mm / 17.6 x 11.0 x 2.0 inches
Weight	Set with Stand	3.0 kg / 6.61 lbs
	Set without Stand	2.7 kg / 5.95 lbs
TV System	TV	Analogue :B/G, D/K, L, I(Depending on your country selection) Digital: DVB-T/DVB-C
	Colour Video	Analogue: PAL, SECAM, NTSC-4.43, NTSC-3.58, PAL60 Digital: MPEG-2 MP@ML, MPEG-4, H.264/AVC MP@L3 MP@L4.0, HP@L4.0
	Sound	BG, DK, L, NICAM, MPEG1, DD, DD+, HEAAC



Specifications	
Item	Description
Environmental Considerations	Operating Temperature : 32°F ~ 122°F (0°C ~ 50°C) Operating Humidity : 20% ~ 90% Storage Temperature : -4°F ~ 140°F (-20°C ~ 60°C) Storage Humidity : 10% ~ 90%
Audio Specifications	MAX Internal Audio Output Power : Each 3 W(Left/Right) Equalizer : 5 Band Output Frequency : <ul style="list-style-type: none">• RF : 20 Hz ~ 15.4 kHz• AV/Componet/HDMI : 20 Hz ~ 20 kHz
Note : Dolby Digital Plus/Pulse, USB2.0, Film mode, Energy Saving	

2-1-3. Specification Comparison to Old Models

Model	UE5L(UE**E*5****)		UD5R(UE**D5500R*)	
Design				
Display Type	LED TV		LED TV	
Built-in Tuner	O		O	
Resolution	1920 x 1080		1920 x 1080	
LCD Panel	TFT LCD Panel 60 Hz		TFT LCD Panel 60 Hz	
Screen Size	22"/32"/37"/40"/46"		32"/37"/40"/46"	
Picture ratio	16 : 9		16 : 9	
Power Consumption	22"	30 W (Under 0.3W, Standby)	32"	30 W (Under 0.3W, Standby)
	32"	60/62 W (Under 0.3W, Standby)	37"	90 W (Under 0.3W, Standby)
	37"	79/81 W (Under 0.3W, Standby)	40"	103 W (Under 0.3W, Standby)
	40"	87 W (Under 0.3W, Standby)	46"	134 W (Under 0.3W, Standby)
	46"	92/95 W (Under 0.3W, Standby)		
Dimensions (W x H x D)	22"	20.2 x 14.3 x 6.3 inches_with stand 20.2 x 12.4 x 2.0 inches_without stand	32"	30.2 x 20.9 x 9.4 inches_with stand 30.2 x 18.4 x 1.2 inches_without stand
	32"	29.1 x 19.6 x 7.5 inches_with stand 29.1 x 17.5 x 3.7 inches_without stand	37"	35.1 x 23.7 x 10.0 inches_with stand 35.1 x 21.2 x 1.2 inches_without stand
	37"	34.1 x 22.7 x 9.8 inches_with stand 34.1 x 20.4 x 3.7 inches_without stand	40"	37.6 x 25.1 x 10.0 inches_with stand 37.6 x 22.6 x 1.2 inches_without stand
	40"	36.5 x 19.6 x 7.5 inches_with stand 36.5 x 17.5 x 3.7 inches_without stand	46"	43.0 x 28.1 x 10.8 inches_with stand 43.0 x 25.6 x 1.2 inches_without stand
	46"	41.7 x 26.8 x 9.0 inches_with stand 41.7 x 24.6 x 3.7 inches_without stand		
Weight	22"	7.72 lbs_with stand 7.28 lbs_without stand	32"	22.00 lbs_with stand 15.90 lbs_without stand
	32"	14.11 lbs_with stand 12.57 lbs_without stand	37"	27.60 lbs_with stand 20.30 lbs_without stand
	37"	21.83 lbs_with stand 17.64 lbs_without stand	40"	31.70 lbs_with stand 24.40 lbs_without stand
	40"	24.25 lbs_with stand 19.84 lbs_without stand	46"	38.10 lbs_with stand 30.30 lbs_without stand
	46"	30.86 lbs_with stand 26.46 lbs_without stand		
Contrast Ratio	MEGA		MEGA	
Picture Enhancer	HyperReal Engine (X9)		HyperReal Engine (X6)	

Model	UE5L(UE**E*5****)		UD5R(UE**D5500R*)	
Wide Color Enhance Plus	Wide Color Enhance Plus		Wide Color Enhance Plus	
Equalizer	5 Band		5 Band	
Auto Volume Control	O		O	
Surround Sound	Dolby Digital Plus / Pulse		Dolby Digital plus	
Speaker Output	22"	3 W x 3 W	32"	10 W x 10 W
	32"	10 W x 10 W	37"	10 W x 10 W
	37"	10 W x 10 W	40"	10 W x 10 W
	40"	10 W x 10 W	46"	10 W x 10 W
	46"	10 W x 10 W		
PIP	O		O	
Function	Jog Function		Touch Function	
Caption	O		O	
Game Mode	O		O	
Energy Saving	O		O	
Network	X		DLNA	
Anynet+	X		O	
Antenna	1(Cable/Air)		1(Cable/Air)	

2. Product specifications

Model	UE4J(UE**E*4****)		UD4N(UE32D4000NW)	
Design				
Display Type	LED TV		LED TV	
Built-in Tuner	O		O	
Resolution	1366 x 768		1366 x 768	
LCD Panel	TFT LCD Panel 60 Hz		TFT LCD Panel 60 Hz	
Screen Size	19"/26"/32"		19"/32"	
Picture ratio	16 : 9		16 : 9	
Power Consumption	19"	27 W (Under 0.3W, Standby)	19"	40 W (Under 0.3W, Standby)
	26"	40/41 W (Under 0.3W, Standby)	32"	70 W (Under 0.3W, Standby)
	32"	52/54 W (Under 0.3W, Standby)		
Dimensions (W x H x D)	19"	17.6 x 12.9 x 6.3 inches_with stand 17.6 x 11.0 x 2.0 inches_without stand	19"	18.8 x 14.7 x 7.5 inches_with stand 18.8 x 12.6 x 1.2 inches_without stand
	26"	24.2 x 16.5 x 7.7 inches_with stand 24.2 x 14.4 x 3.7 inches_without stand	32"	30.1 x 20.8 x 8.8 inches_with stand 30.1 x 18.2 x 8.8 inches_without stand
	32"	29.1 x 19.4 x 7.5 inches_with stand 29.1 x 17.2 x 3.7 inches_without stand		
Weight	19"	6.61 lbs_with stand 5.95 lbs_without stand	19"	8.60 lbs_with stand 7.90 lbs_without stand
	26"	9.92 lbs_with stand 8.82 lbs_without stand	32"	19.80 lbs_with stand 15.40 lbs_without stand
	32"	13.89 lbs_with stand 12.57 lbs_without stand		
Contrast Ratio	MEGA		MEGA	
Picture Enhancer	HyperReal Engine (X9)		HyperReal Engine (X5/X9)	
Wide Color Enhance Plus	Wide Color Enhance Plus		Wide Color Enhance Plus	
Equalizer	5 Band		5 Band	
Auto Volume Control	O		O	
Surround Sound	Dolby Digital Plus / Pulse		Dolby Digital plus	
Speaker Output	19"	3 W x 3 W	19"	3 W x 3 W
	26"	5 W x 5 W	32"	10 W x 10 W
	32"	10 W x 10 W		
PIP	X		O	
Function	Jog Function		Touch Function	

Model	UE4J(UE**E*4****)	UD4N(UE32D4000NW)
Caption	O	O
Game Mode	O	O
Energy Saving	O	O
Network	X	X
Anynet+	X	O
Antenna	1(Cable/Air)	1(Cable/Air)

2-2. Detail Factory Option



NOTE

If you replace the main board with new one, please change the factory option as well.
The options you must change are "Type".

■ 5000

Model Name		UE32EH5****	UE37EH5****	UE40EH5****	UE46EH5****	
Panel	Vendor	CHILIN AML AUO	AUO	AML SHARP	AML	
	Code	BN07-01096A BN95-00586A BN07-01113A	BN07-01194A	BN95-00587A BN95-00713A	BN95-00589A	
	Spec.	DE320BGM-C1 LTJ320HN07-V DE320BGA-B1	DE370BGA-C1	LTJ400HM08-V DE400BGS-V1	LTJ460HN05-V	
SMPS	Vendor	HANSOE SEM	SEM	SEM	SEM	
	Code	BN44-00493B BN44-00493A	BN44-00496A	BN44-00496A	BN44-00497A	
	Spec.	PD32AVF_CHS PD32AVF_CSM	PD40AVF_CSM	PD40AVF_CSM	PD46AVF_CSM	
Byte	Item	Chassis Ass'y	BN91-06355C	BN91-09447H	BN91-06355E	BN91-06355G
0	Factory Reset	PBA Ass'y code	BN94-05548C	BN94-05842H	BN94-05548E	BN94-05548G
1	Type		32P6AF0D 32A6AF0D 32R6AF0D	37P6AF0D	40A6AF0D 40H6AF0D	46A6AF0D
2	Model		UE5000	UE5000	UE5000	UE5000
3	SVC Model		5000	5000	5000	5000
4	Local Set		EU	EU	EU	EU
5	Tuner		SI_ATC2	SI_ATC2	SI_ATC2	SI_ATC2
6	Ch Table		SESK	SESK	SESK	SESK
7	Front Color		U-S-C-5K	U-S-C-5K	U-S-C-5K	U-S-C-5K



■ 4000

Model Name		UE26EH4****	UE32EH4****
Panel	Vendor	CHILIN	AML AUO CSOT
	Code	BN07-01094A	BN95-00585A BN07-01112A BN07-01245A
	Spec.	DE260AGM-C1	LTJ320AP03-V DE320BGA-B1
SMPS	Vendor	SEM	SEM
	Code	BN44-00491A	BN44-00492A
	Spec.	PD26AV0_CSM	PD32AV0_CSM
Byte	Item	Chassis Ass'y	
0	Factory Reset	PBA Ass'y code	
1	Type		
2	Model		
3	SVC Model		
4	Local Set		
5	Tuner		
6	Ch Table		
7	Front Color		

■ UE22ES5000*_UE19ES4000*

Model Name		UE22ES5000*	UE19ES4000*
Panel	Vendor	AML	AML
	Code	BN07-01044A	BN07-01043A
	Spec.	LTM215HT04-V	LTM185AT05-V
SMPS	Vendor	POWER	POWER
	Code	BN44-00504A	BN44-00504A
	Spec.	PD23A0T_CPN	PD23A0T_CPN
Byte	Item	Chassis Ass'y	
0	Factory Reset	PBA Ass'y code	
1	Type		
2	Model		
3	SVC Model		
4	Local Set		
5	Tuner		
6	Ch Table		
7	Front Color		

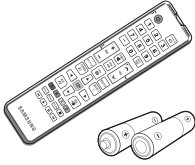
2-3. Accessories

Product	Description	Code. No	Remark
	Remote Control	AA59-00602A	Samsung Electronics Service center
	Batteries (AAA x 2)	4301-000121	
	Power Cord	3903-000603	
	Owners Manual	BN68-03955A BN68-03951A	

3. Disassembly and Reassembly

This section of the service manual describes the disassembly and reassembly procedures for the LED TV.



WARNING

This LED TV contains electrostatically sensitive devices. Use caution when handling these components.



3-1. Disassembly and Reassembly



CAUTION

1. Disconnect the LED TV from the power source before disassembly.
2. Follow these directions carefully; never use metal instruments to pry apart the cabinet.
3. If there is no additional coment, it is same for all inches.

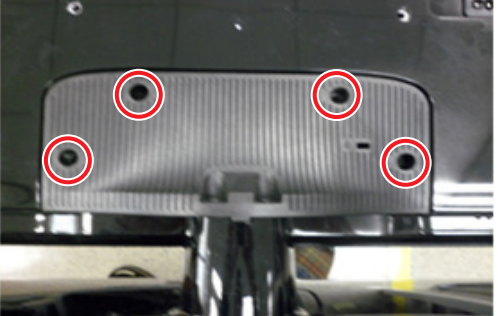
■ 5000

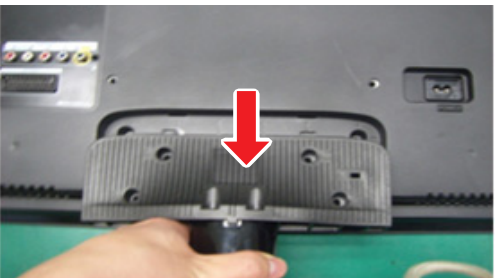
Description	Picture Description	Screws
<p>1 Place TV face down on cushioned table.</p>		
<p>2 Remove 4 screws from the Stand.</p>		 6003-001782
<p>3 Remove Stand.</p>		



3. Disassembly and Reassemble

Description	Picture Description	Screws
<p>4 Remove 1 screw of Cover-Jack.</p> <p>Remove 11 screws of Rear-Cover.</p>	 	 6003-001782 6003-002755
<p>5 Remove the Cover-Jack.</p> <p>Remove the Rear-Cover.</p>	 	

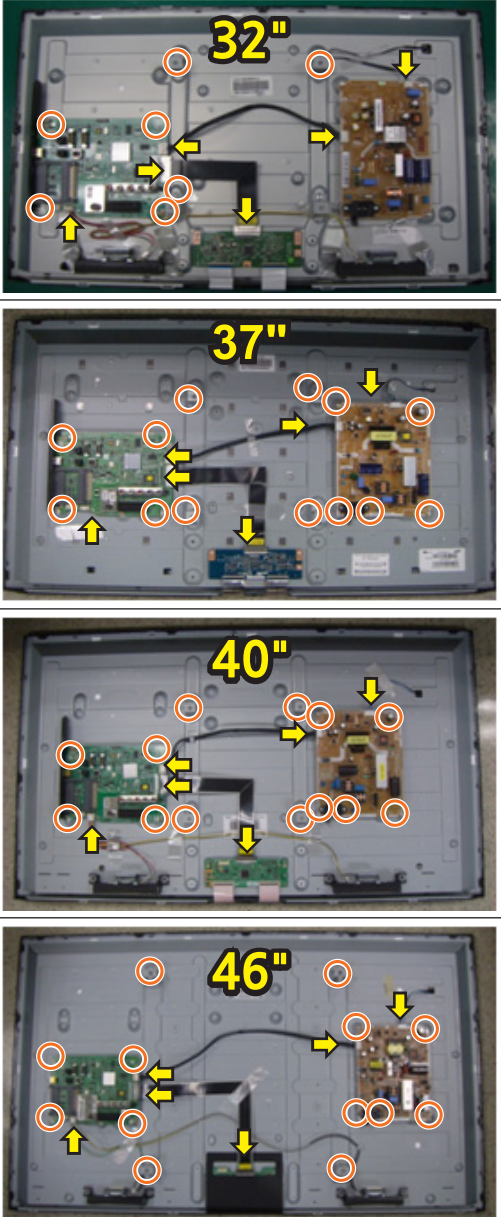

Description	Picture Description	Screws
<p>6 Disconnect the Function Ass'y Cable.</p>		
<p>7 Remove the screws of Rear-Cover.</p> <ul style="list-style-type: none"> • 32" / 37" : 12 EA • 40" : 13 EA • 46" : 15 EA 		<p>6003-001782</p> <p>6003-002755 (Machine)</p>

3. Disassembly and Reassemble

Description	Picture Description	Screws
8 Remove the Rear-Cover.	<p>A close-up photograph showing a person's hand holding a black plastic rear cover. The cover has yellow text "32\"/37\"/40\" printed on it. A red arrow points upwards from the bottom edge of the cover towards the internal components of the device.</p>	
	<p>A close-up photograph showing a person's hand holding a black plastic rear cover. The cover has yellow text "46\" printed on it. A red arrow points upwards from the bottom edge of the cover towards the internal components of the device.</p>	

Description	Picture Description	Screws
<p>9 Remove the 13 screws of Main Board and SMPS Board and Panel.</p>		 <p>6001-002756</p>

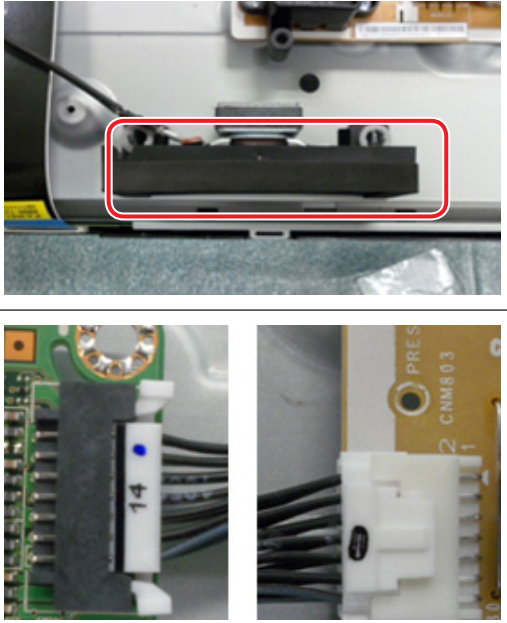
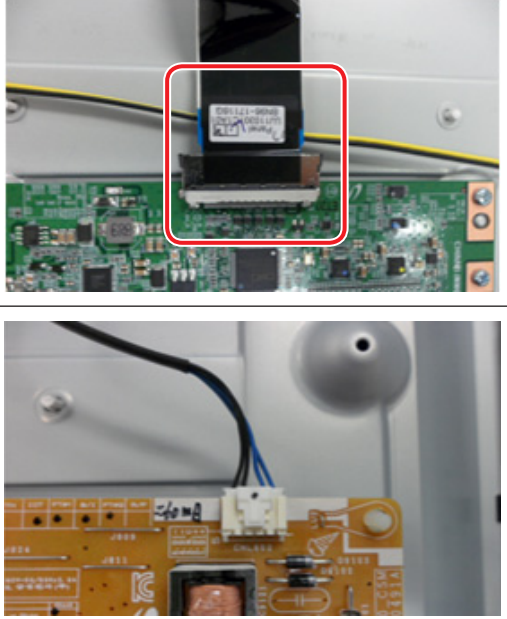
3. Disassembly and Reassemble







Description	Picture Description	Screws
<p>10 Remove the Speakers and Power Cables.</p>		
<p>11 Remove the LVDS Cable and Panel Drive Cable.</p>		
<p>12 Completed disassembly.</p>		



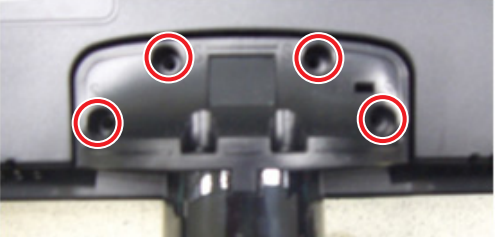

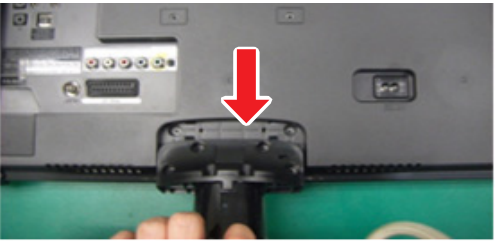

NOTE

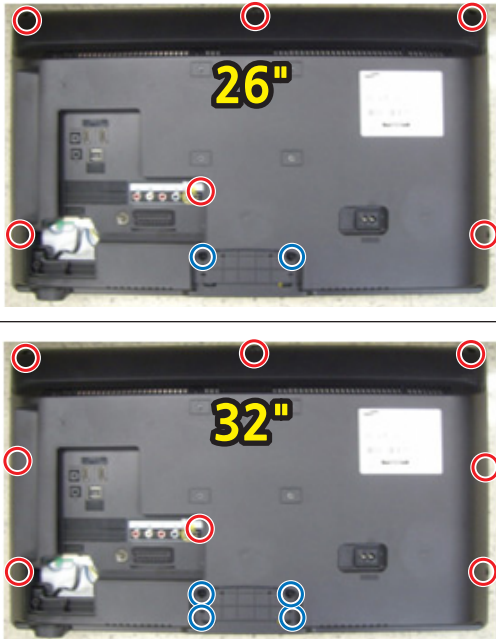

Reassembly procedures are in the reverse order of disassembly procedures.

■ 4000

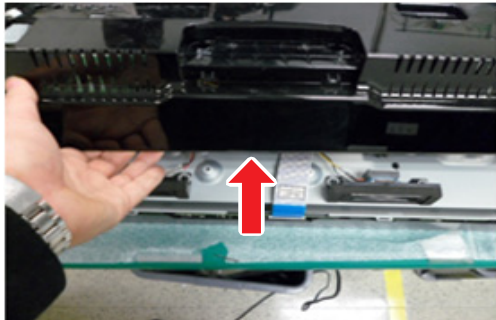
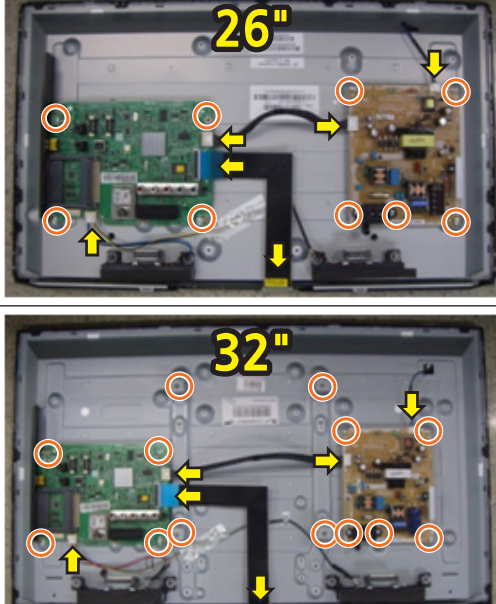
Description	Picture Description	Screws
<p>1 Place TV face down on cushioned table.</p>		
<p>2 Remove 4 screws from the Stand.</p>		 <p>6003-001782</p>
<p>3 Remove Stand.</p>		
<p>4 Remove 1 screw of Cover-Jack.</p>		 <p>6003-001782</p>
<p>5 Remove the Cover-Jack.</p>		
<p>6 Disconnect the Function Ass'y Cable.</p>		

3. Disassembly and Reassemble

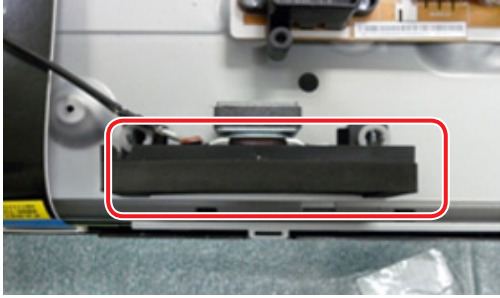
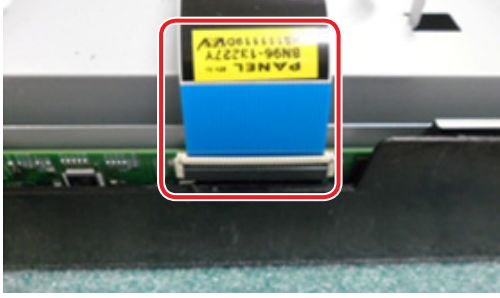
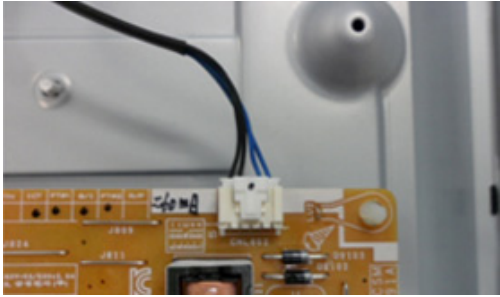





Description	Picture Description	Screws
<p>7 Remove the screws of Rear-Cover.</p> <ul style="list-style-type: none"> • 26" : 8 EA • 32" : 12 EA 		 <p>6003-001782</p>  <p>6003-002755 (Machine)</p>
<p>8 Remove the Rear-Cover.</p>		
<p>9 Remove the screws of Main Board and SMPS Board and Panel.</p> <ul style="list-style-type: none"> • 26" : 9 EA • 32" : 13 EA 		 <p>6001-002756</p>





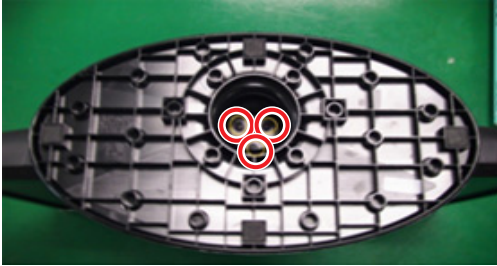

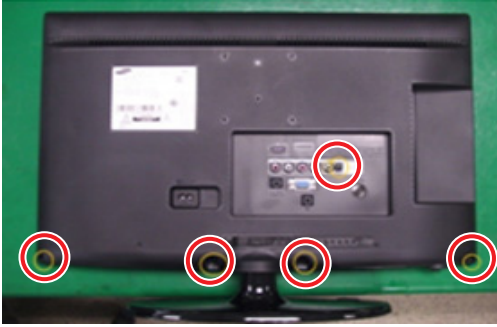
Description	Picture Description	Screws
10 Remove the Speakers and Power Cables.		
11 Remove the LVDS Cable and Panel Drive Cable.	 	
12 Completed disassembly.		

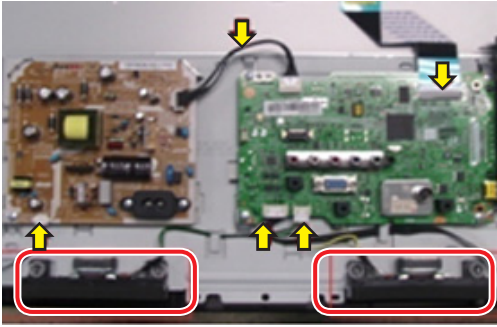
**NOTE**

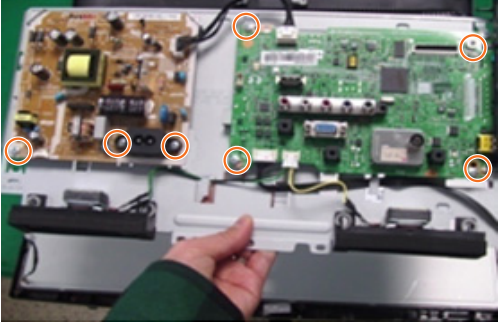
Reassembly procedures are in the reverse order of disassembly procedures.

■ UE19ES4000*_UE22ES5000*

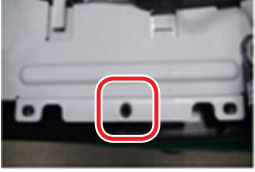
Description	Picture Description	Screws
<p>1 Place TV face down on cushioned table.</p>		
<p>2 Remove 3 screws from the Stand. Remove Stand.</p> <p> NOTE If you want to remove the only rear cover, you don't need to remove the stand)</p>		 6003-001782
<p>3 Remove 5 screws of Rear-Cover.</p>		 6003-001782
<p>4 Lift up the Rear-Cover.</p>		
<p>5 Separate the Left/Right Speaker, Cables.</p>		

Description	Picture Description	Screws
<p>6 Remove the screws of Main Board and SMPS Board.</p> <ul style="list-style-type: none"> Remove the 4 screws of Main Board. Remove the 3 screws of SMPS Board. <p> NOTE</p> <ul style="list-style-type: none"> If you need, Side Bracket also. If you want to change the only Panel, you don't need to separate Boards and cables (except LVDS). 		 <p>6001-002756 (Machine)</p>
<p>7 Lift up the Panel.</p> <p> NOTE</p> <p>If you re-assemble, you should keep the stop-point.</p>	  	

**NOTE**

Reassembly procedures are in the reverse order of disassembly procedures.

■ Screw Size

Code No.	COLOR	A (mm)	B (mm)	C (mm)	Q'ty
6003-001782	BLACK	7.80~8.30	11.20~12.00	3.81~3.91	5K - 32" : 13EA, 37" : 13EA, 40" : 14EA, 46" : 18EA 4K - 26" : 11EA, 32" : 13EA
6001-002755	BLACK	7.1~7.5	5.7~6.0	2.98~3.02	5K - 32" : 4EA, 37" : 4EA, 40" : 4EA, 46" : 12EA 4K - 26" : 2EA, 32" : 4EA
6001-002756	WHITE	7.1~7.5	5.7~6.0	2.98~3.02	5K - 32" : 13EA, 37" : 13EA, 40" : 13EA, 46" : 13EA 4K - 26" : 9EA, 32" : 13EA

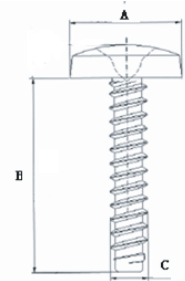

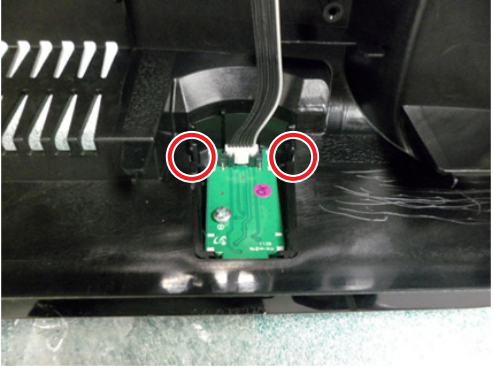
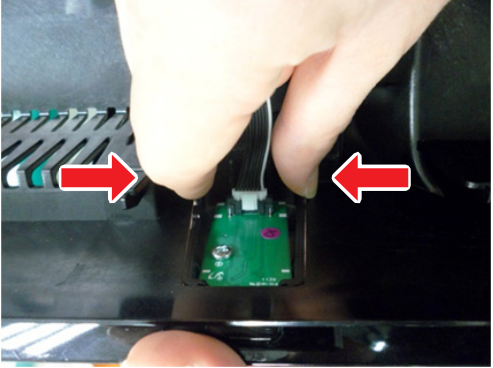
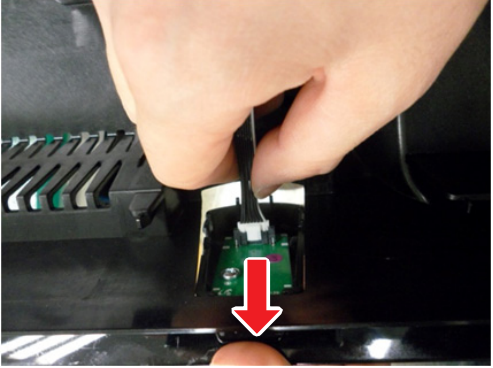

3-2. Assy Board P-Jog Switch & Ir

■ How to disassembly

Description	Picture Description	Refer
1 Check the 2 Locking Holders.		
2 Press both holders.		
3 Remove the Function Assy.		

■ How to assembly





Description	Picture Description	Refer
<p>1 Check the locking hole.</p>		
<p>2 Combine the function assy to locking hole.</p>		
<p>3 Press the function assy to TV.</p>		

When you want to ignore the funtion key actions

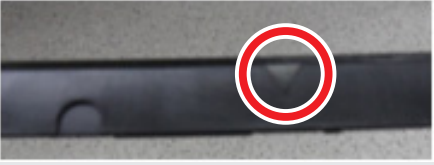

<ul style="list-style-type: none"> Option <li style="border: 2px solid yellow;">Control SVC Expert ADC/WB Advanced 	<p>Config Option</p>	<p>Navigation Key Func</p>	<p>0 : New Function (Naviagtion) Key ➡ [Default] 1 : Old Function (Touch) Key 2 : Do not work Function key</p>
--	----------------------	----------------------------	---

3-3. Disassembly(PTC)



■ How to disassembly

Description	Picture Description	Refer
<p>1 Place TV face up on cushioned table.</p>		
<p>2 Remove the ASSY Function assy.</p>		
<p>3 Spread the both sides of PTC upper (marked "▼") by use the tool.</p> <p>! CAUTION Do not scratch on both side by use tool. Gate Cof will be damaged.</p> 	 	

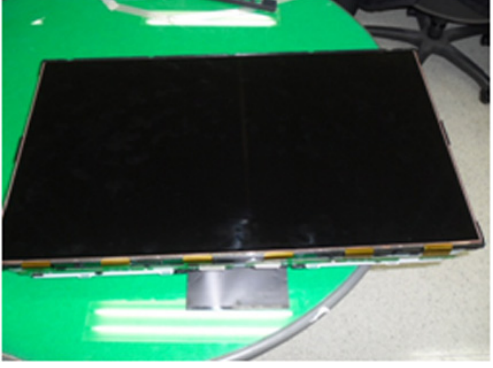



3. Disassembly and Reassemble

Description	Picture Description	Refer
<p>4 Separate the left and right side of the PTC as shown.</p>		
<p>5 Separate the Bottom of the PTC as shown</p>		
<p>6 Raise up the PTC Bottom.</p>		
<p>7 Disassembly is complete.</p>		

■ How to reassembly

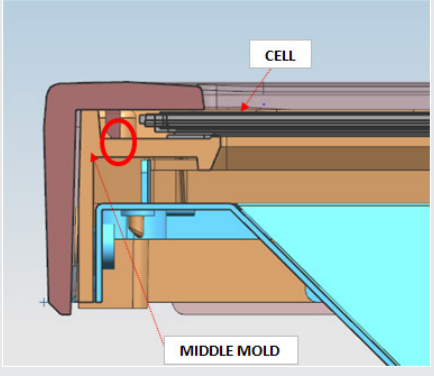
Description	Picture Description	Refer
1 Attach the PTC Bottom first to the Panel.		
2 Secure the plastic latch on the left and right side of the PTC as shown.		

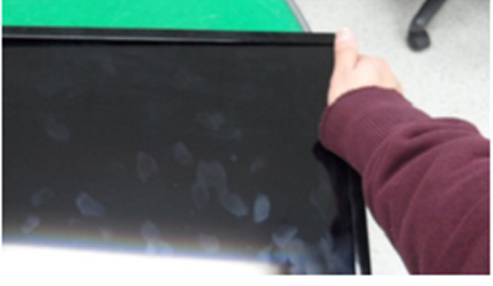
3. Disassembly and Reassemble

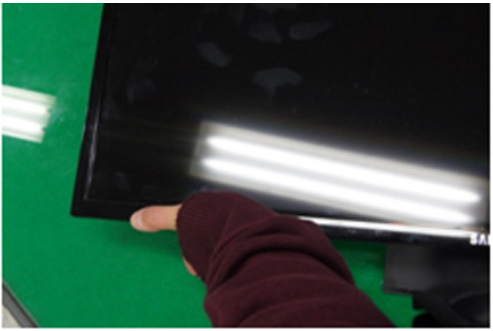
Description	Picture Description	Refer
<p>3 Visually inspect the spacing between the PTC and the Panel for equal clearance.</p> <p>! CAUTION Combine to stick the PTC Rib into the middle mold.</p> 	    	

Description	Picture Description	Refer
4 Assembly is complete.		

4. Troubleshooting

4-1. Troubleshooting

■ Previous Check

1. Check the various cable connections first.
 - Check to see if there is a burnt or damaged cable.
 - Check to see if there is a disconnected or loose cable connection.
 - Check to see if the cables are connected according to the connection diagram.
2. Check the power input to the Main Board.

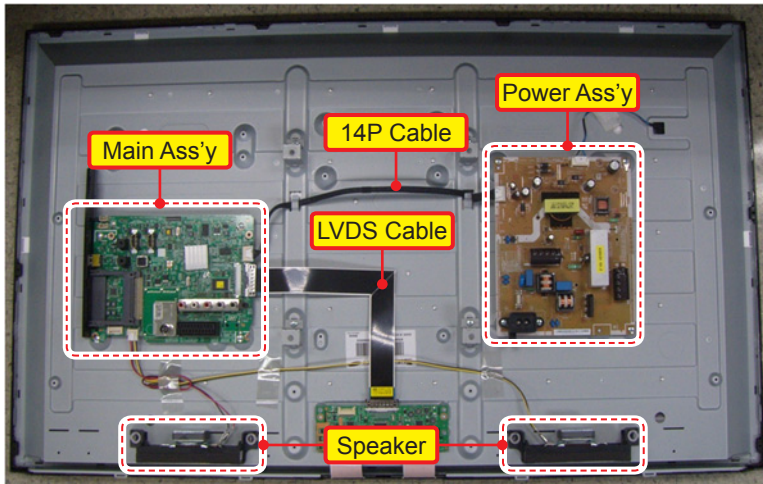

Main Board Assy (CN201)			
13	B13V	14	B13V
11	B13V	12	B13V
9	B13VS	10	SW_INV
7	B13VS	8	GND
5	GND	6	GND
3	B5.3V	4	A5.3V
1	B5.3V	2	SW_PW

Power Board Assy (CNM803)			
14	B13V	13	B13V
12	B13V	11	B13V
10	SW_INV	9	B13VS
8	GND	7	B13VS
6	GND	5	GND
4	A5.3V	3	B5.3V
2	SW_PW	1	B5.3V

* Change the 12 PIN to B13V(2012) from NC(2011)

3. Check the power in & output between IP & Main Board, Main Board & Panel, IP & Panel.

■ How to know it is from Main Board or T-Con when some problems happen

1. No Picture : Backlight is on, but there is no picture and LED indicator in front of TV is blinking.
 - Check the LVDS Cable connection. If still problems, change the T-Con Board and then Main Board step by step.
2. Picture distortion : Enter the service mode → Choose 'SVC' → Check the 'internal pattern.'

- Enter 'Service Mode.'

- If you do not have Factory remote control



- If you have Factory remote control



3. Choose 'SVC.'
4. Choose 'Test pattern.'
5. Select the each pattern and then check all pattern is ok or not.



Pattern Status is	Change the	Test Pattern is made by the MSTAR IC
OK	Main Board	We guess front of MSTAR IC has problem.
NG	Panel and T-Con Board	We guess back of MSATR IC has problem.

■ Power-Tree

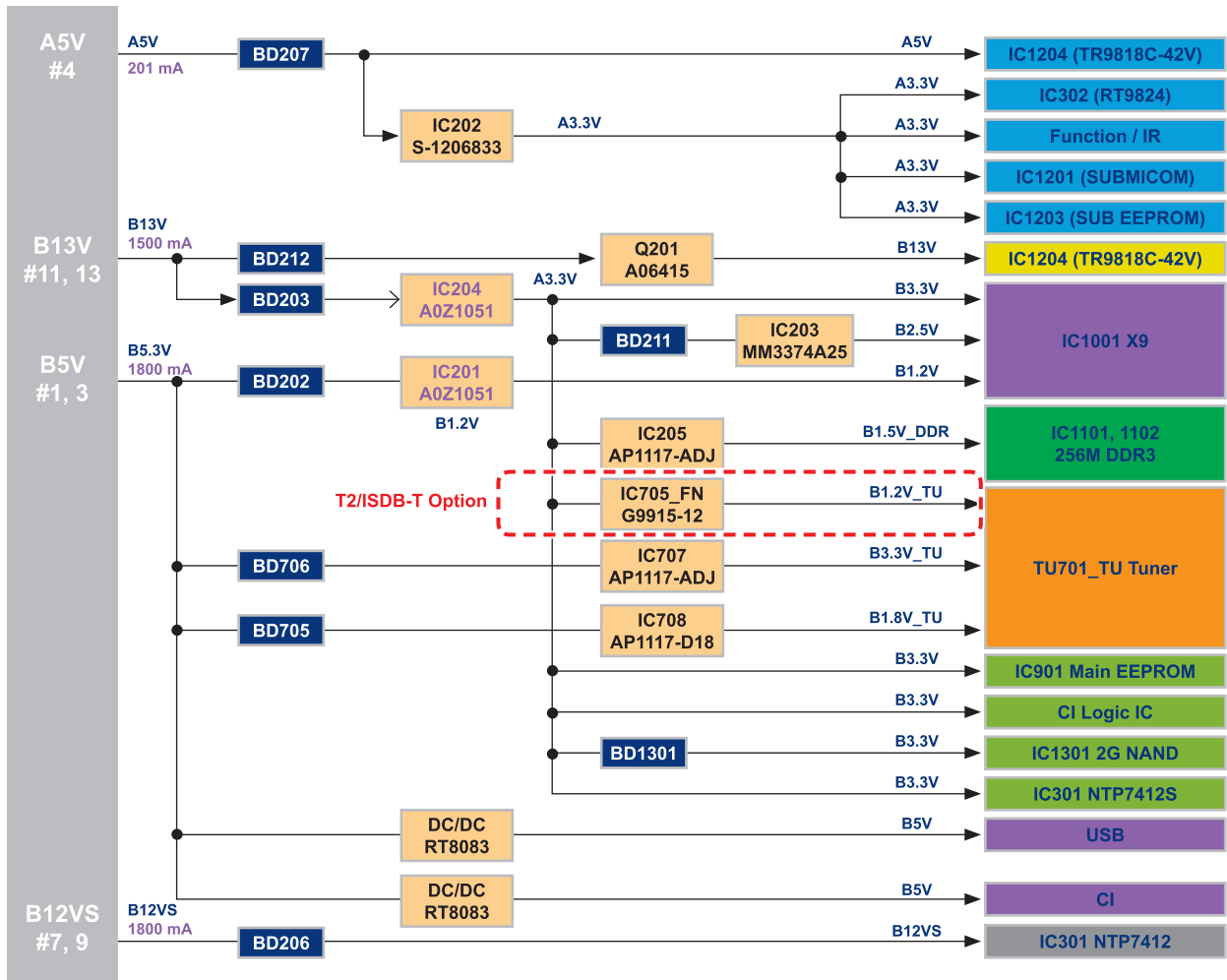

■ Simple flow chart of malfunction

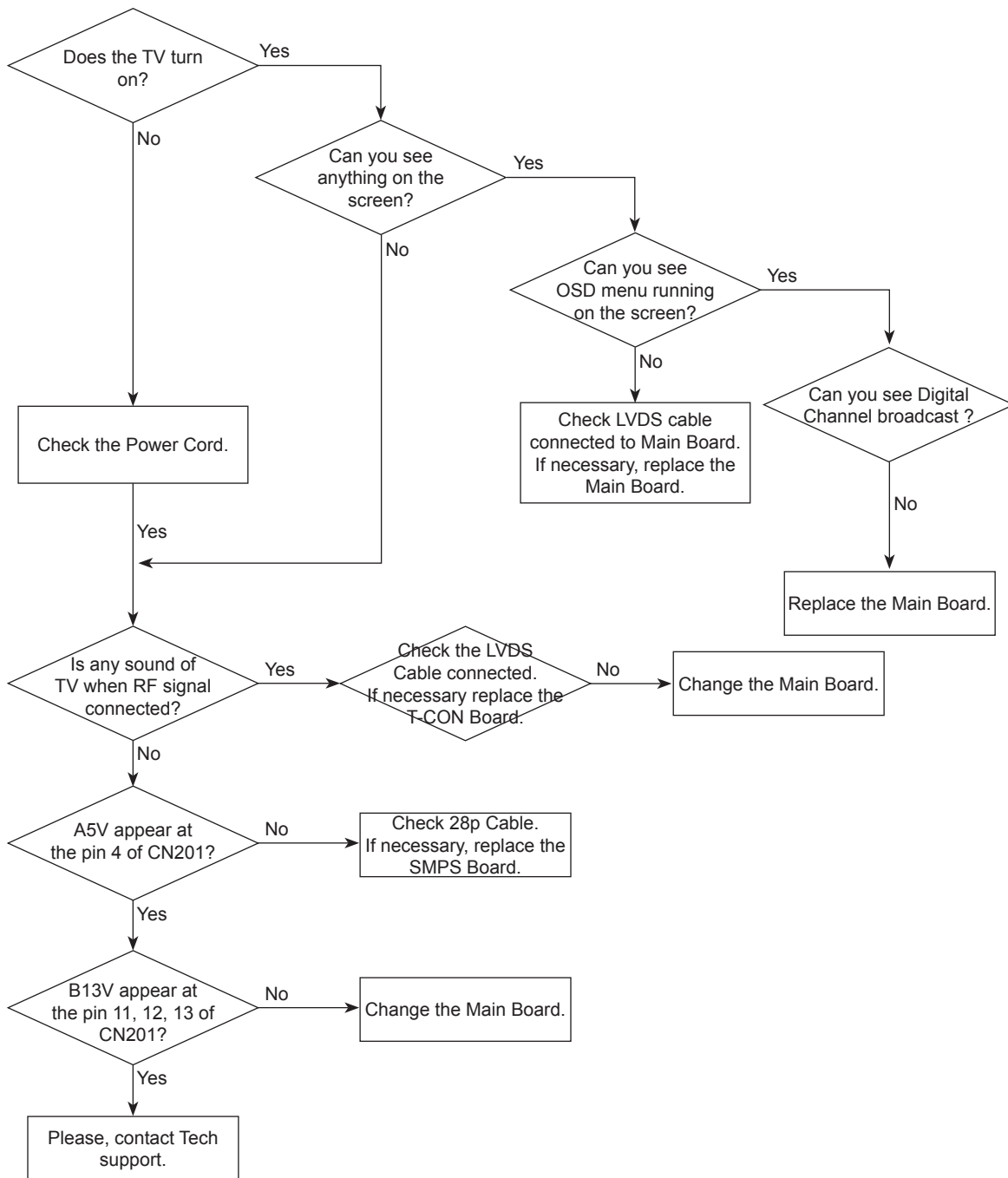

4-2. How to Check Fault Symptom

■ NO Power and No Video

<p>Symptom</p>	<ul style="list-style-type: none"> • The LEDs on The front panel do not work when connecting The power cord. • The SMPS relay does not work when connecting The power cord. • The units appears to be dead.
<p>Major checkpoints</p>	<p>The IP relay or the LEDs on the front panel does not work when connecting the power cord if the cables are improperly connected or the Main Board or SMPS is not functioning. In this case, check the following:</p> <ul style="list-style-type: none"> • Check the internal cable connection status inside the unit. • Check the fuses of each part. • Check the output voltage of SMPS. • Replace the Main Board.
<p>Diagnostics</p>	<pre> graph TD Start[Power cord on.] -- Yes --> Q1{Check 'Stand-By A5.3V' 5.3V appear at BD210? 0V to 5.3V (CN201 #4)} Q1 -- No --> C1[Cause : There did not supply the power from SMPS. Measure : Change 14p power cable and SMPS.] Q1 -- Yes --> S1[Set On.] S1 -- Yes --> Q2{Check 'SW_POWER' more than 3.3V appear at CN201(#2) ? 0V to 3.3V↑ (CN201 #2)} Q2 -- No --> C2[Cause : Main IC(X9) did not control the SW_Power. Measure : Change the Main Assy.] Q2 -- Yes --> Q3{Check 'Power input of Main Ass'y' ? DC B13V, B5.3V appear at CN201 #11,12,13(B13V) CN201 #1,3 (B5.3V)? 0V to 13V (CN201 #11,12,13) 0V to 5.3V (CN201 #1,3)} Q3 -- No --> C3[Cause : There did not supply the power from SMPS. Measure : Change 14p power cable and SMPS.] Q3 -- Yes --> Q4{Check 'Power of main IC(B1.2V/B2.5V)' Check 'Power of DDR IC(B1.5V)' appear at TP-1.2V, TP-B2.5V, TP-B1.5V(1.5V) 0V to 1.2V (TP-1.2V) 0V to 2.5V (TP-2.5V) 0V to 1.5V (TP-1.5V)} Q4 -- No --> C4[Cause : There is proble at DCDC(IC203) / LDO(IC204). Measure : Change the Main Assy.] Q4 -- Yes --> Q5{Check 'Power of LVDS (13V)' appear at TP-PANEL_VCC? 0V to 13V (TP-PANEL_VCC)} Q5 -- No --> C5[Cause : There is proble at FET(Q201) or Main IC(X9) did not control the SW_PVCC. Measure : Change the Main Assy.] </pre>

4. Troubleshooting

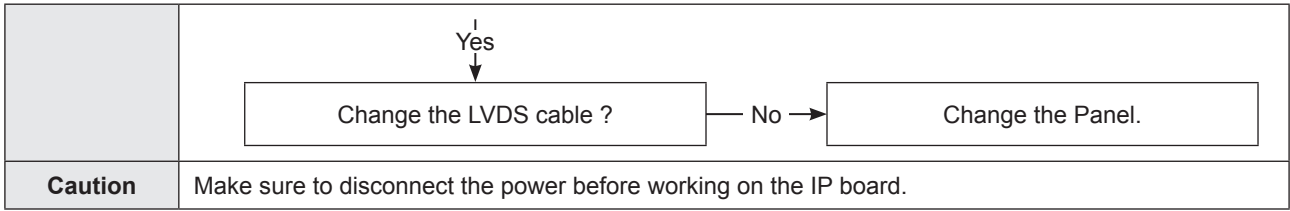

■ Location of Parts

Main Board_Front

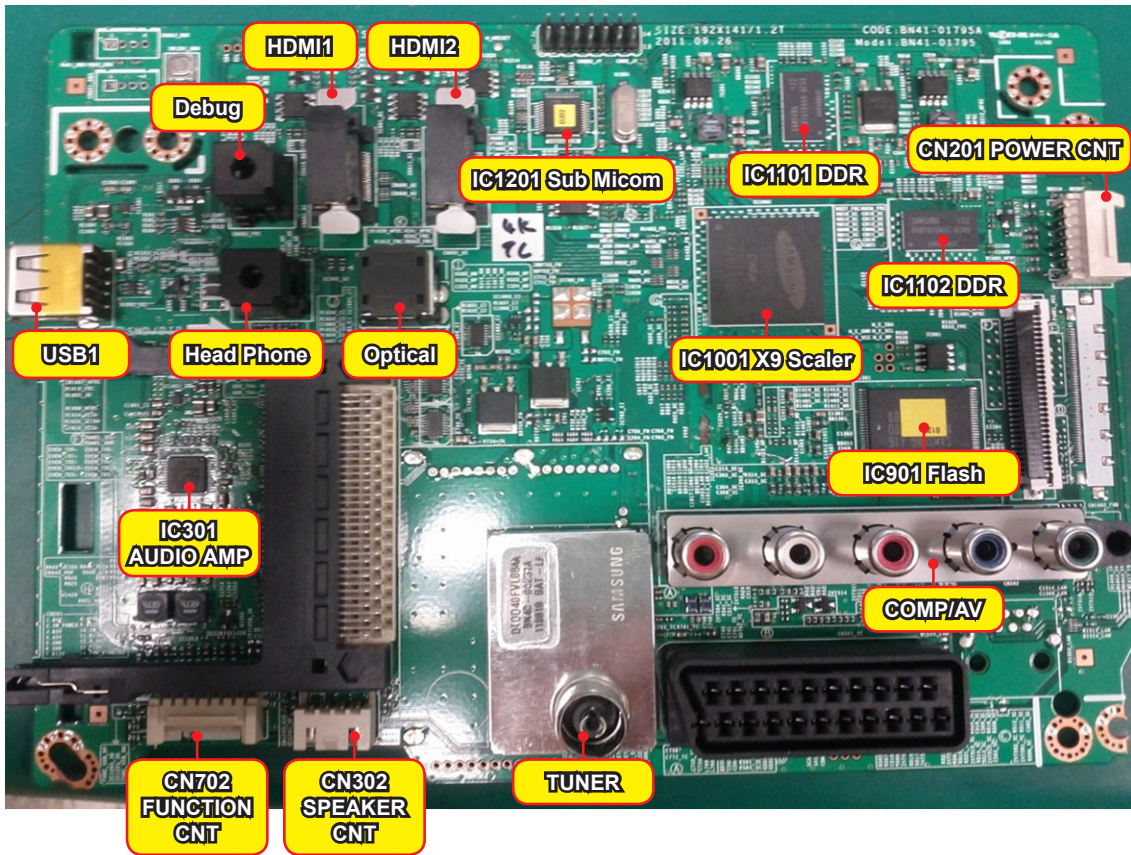

CN201 POWER CNT

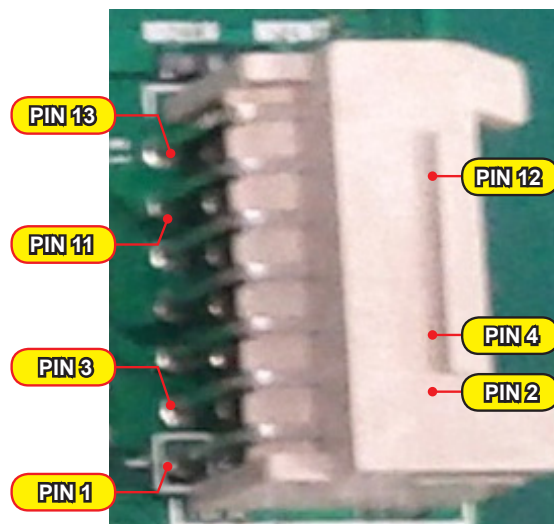

4-3. Factory Mode Adjustments

4-3-1. Entering Factory Mode

To enter 'Service Mode' Press the remote -control keys in this sequence :

- If you do not have Factory remote control



- If you have Factory remote control



- If you don't have Factory remote control, can't control some menus. (Expert, Advanced menu)

Option	T-MST0DEUC : SW Ver
Control	T-MST0DEUS : SW Ver
SVC	EDID : SUCCESS
Expert	HDCP : SUCCESS
ADC/WB	CALIB : AV / COMP / PC / HDMI /
Advanced	OPTION:**
	FactoryCS:*****
	T-MSXDEUCIP_****
	Onboot : ***
	SDAL_****
	RFS:Mstar-X9 ****
	20**_**_**

- How to enter the hidden factory mode.
 1. Into the factory mode.
 2. Move the tap to Advanced.
 3. Key input : 0 + 0 + 0 + 0.



NOTE

hidden menu : Advanced

4-3-2. Factory Data



Note

- Version of the software is written in 0002.
- Black : I should not be possible to adjust or change that does not require a change item
- Blue : Adjustment Services for the corresponding
- Red : Items that are secured

■ Option

Factory Menu Name	Data	Range	Remark	Key
Factory Reset	-	-		
Type	22A6AF1E 32P6AF0D / 32A6AF0D 37P6AF0D 40A6AF0D / 40H6AF0D 46P6AF0D		use to change panel	
Model	UE5000			
SVC Model	5000			
Local Set	Other			
Tuner	SI_ATSC2		do not change	
Ch Table	SAMEX			
Front Color	U-S-C-5K			

■ Control

Factory Menu Name	Data	Range	Remark	Key
EDID				
EDID ON/OFF	Off	On/Off		
EDID WRITE ALL		Success/Failure	use to write the EDID	
EDID WRITE PC		Success/Failure		
EDID WRITE DVI		Success/Failure		
EDID WRITE HDMI1		Success/Failure		
EDID WRITE HDMI2		Success/Failure		
EDID WRITE HDMI3		Success/Failure		
EDID WRITE HDMI4		Success/Failure		
EDID VERSION		HDMI 1.3/HDMI1/2		
Sub Option				
Mute Time(VIDEO)	4	0~10		
ready	Off	On/Off		
HotPlug	On			
Hotplugcontrol	On			

4. Troubleshooting

Factory Menu Name	Data	Range	Remark	Key
Spread Spectrum				
Spread Spectrum	On	On/Off		
Period	60K	40K/50K/60K		
Amplitude	2	0/0.5/1/1.5/2		
DDR Spread	2%	Off/1%/2%		
Auto Power	On			
Mirror	ON	ON/ OFF		
HDMI EQ1	Middle	Low/Middle/High/Strong	use to solve HDMI Noise	
HDMI EQ2	Middle	Low/Middle/High/Strong		
HDMI EQ3	Middle	Low/Middle/High/Strong		
HDMI EQ4	Middle	Low/Middle/High/Strong		
EER Count	-			
WM Calib				
Panel Enter Key				
Panel Display Time	9Hr			
Checksum	XXXX			
View Log				
Font Data Viewer				
Dimm Type	EXT			
Carrier Mute	Off	On/Off		
Anynet+	Off	On/Off		
HPD Polarity				
High Devi	Off	On/Off		
Hot Plug Delay	12	0~63		
HP Ident	High	High/Low		
PC Ident	On	On/Off		
Watchdog	On	On/Off		
LVDS Format	JEIDA	JEIDA / VESA		
OSD Resolution	1366*768			
Bus Stop				
OTA Code				
OTA Duration Test				
Alternate Del				
Ignore VCT Version	On	On/Off		
HDMI Sync	DE	DE/HV	use to solve HDMI problem	
Watch Dog Count	0	-		
PDP Option				

Factory Menu Name	Data	Range	Remark	Key
Hotel Option				
Shop Option				
Shop Mode		ON/OFF		
USB DEMO ON(SEC)				
USB DEMO OFF(SEC)				
Exhibition Mode		ON/OFF		
Sound				
Audio Amp	NTP7412s	NTP7412s/NTP7411s	do not change	
Volume Curve	NT	NT/EU/EA	do not change	
A2K Prescale	20	0~40		
BTSC Mono Prescale	25	0~40		
BTSC stereo Prescale	47	0~40		
SAP Prescale	43	0~40		
BTSC M2S Threshold	0x20	0xA0~0x9F		
BTSC S2M Threshold	0x15	0xA0~0x9F		
BTSC Stereo On Thr	0x20	0xA0~0x9F		
BTSC Stereo Off Thr	0x26	0xA0~0x9F		
SAP Amp On Thr	0x56	0xA0~0x9F		
SAP Amp Off Thr	0x48	0xA0~0x9F		
SAP NSR On Thr	0x35	0xA0~0x9F		
SAP NSR Off Thr	0x7F	0xA0~0x9F		
Carrier NSR On Thr	0x20	0xA0~0x9F		
Carrier NSR Off Thr	0x29	0xA0~0x9F		
MP3 Level	-6dB	-12dB~0dB		
Audio Delay	20ms	0~150ms		
Main Amp Master Vol	199			
Center Amp Master Vol				
Main Amp PWM Mod	142			
Center Amp PWM Mod	103			
Woofer Amp PWM Mod	103			
Woofer Type				
Main Speaker EQ	On			
Center Speaker EQ				
Main EQ CheckSum	-			
Center EQ CheckSum	-			
Woofer EQ CheckSum	-			
Config Option				

4. Troubleshooting

Factory Menu Name	Data	Range	Remark	Key
Num of AV	1	0~3		
Num of PC	0	1~3		
Num of Comp	1	1~3		
Num of HDMI	2	0~4		
Num of SCART	0			
DVI Sound	0	0~1		
Number of HeadPhone	0	0~1		
Num of USB Port				
Num of SPDIF OUT	1	0~1		
LNA SUPPORT	Off	On/Off		
Navigation Key Func	0	0 : New function (Navigation jog) Key 1 : Old function (Touch) Key 2 : don't work function		
Eco Sensor Support	On	On/OFF		
MFT OFFSET				

■ SVC

Factory Menu Name	Data	Range	Remark	Key
Test pattern				
T-CON Download				

■ ADC/WB

Factory Menu Name	Data	Range	Remark	Key
ADC				
AV Calibration	Success	Success / Failure		
Comp Calibration	Success	Success / Failure		
PC Calibration	Success	Success / Failure		
HDMI Calibration	Success	Success / Failure		
ADC Target				
1st_AV_Low	18	0~255		
1st_AV_High	220	0~255		
1st_AV_Delta	1	0~255		
1st_COMP_Low	16	0~255		
1st_COMP_High	235	0~255		
1st_COMP_Delta	1	0~255		
1st_PC_Low	2	0~255		
1st_PC_High	235	0~255		
1st_PC_Delta	1	0~255		

Factory Menu Name	Data	Range	Remark	Key
2nd_Low	1	0~255		
2nd_High	235	0~255		
2nd_Delta	1	0~255		
ADC Result				
1st_AV_Gain	121			
1st_AV_Offset	141			
1st_Comp_Gain	70			
1st_Comp_Gain_Cb	70			
1st_Comp_Gain_cr	70			
1st_Comp_Offset	127			
1st_Comp_Offset_Cb	127			
1st_Comp_Offset_Cr	127			
1st_PC_R_Gain	94			
1st_PC_G_Gain	93			
1st_PC_B_Gatin	94			
1st_PC_R_Offset	127			
1st_PC_G_Offset	127			
1st_PC_B_Offset	127			
2nd_R_Offset	113	0~255		
2nd_G_Offset	113	0~255		
2nd_B_Offset	113	0~255		
2nd_R_Gain	144	0~255		
2nd_G_Gain	144	0~255		
2nd_B_Gain	144	0~255		
WB				
Sub Brightness	128	0~255		
R_Offset	128	0~255		
G_Offset	128	0~255		
B_Offset	128	0~255		
Sub Contrast	128	0~255		
R_Gain	128	0~255		
G_Gain	128	0~255		
B_Gain	128	0~255		
Movie R Offset	133	0~255		
Movie B Offset	129	0~255		
Movie R Gain	131	0~255		
Movie B Gain	64	0~255		

■ Advanced

Factory Menu Name	Data	Range	Remark	Key
PBE				
WB Movie				
Mode	Off	On/Off		
Color Mode	Movie			
Color Tone	Cool			
Msub Brigh	128			
Msub Contr	128			
W1_RGAIN	138			
W1_BGAIN	104			
W1_ROFFS	130			
W1_BOFFS	127			
W2_RGAIN	131			
W2_BGAIN	64			
W2_ROFFS	133			
W2_BOFFS	129			
W3_RGAIN	128			
W3_BGAIN	128			
W3_ROFFS	128			
W3_BOFFS	128			
N_RGAIN	131			
N_BGAIN	122			
N_ROFFS	128			
N_BOFFS	129			
Movie Countr	100			
Movie Brigh	45			
Movie Color	55			
Movie Sharp	55			
Movie Tint	50			
Movie BkLight	10			
M.Gamma	Off			
M_Sub Gamma	0			
EPA Standard				
Std Contr	100	0~100		
Std Bright	45	0~100		
Std Sharp	50	0~100		
Std Color	50	0~100		

Factory Menu Name	Data	Range	Remark	Key
Std Tint	50	0~100		
Std Backlight	8	0~10		
ADJUST				
Dynamic Dimming	Off	On/Off		
Power Key Protects	Off	On/Off		
UART Select	Auto Wall	Auto Wall/Debug/MDC/On1/ On2		
Debug Mode	Debug Off	Debug Off/Debug Smart/Debug RunTime		
Back End Mute				
PDP FRC				
VisualTEST Plus	Disable			
Standby Mode Time	45 Min	2 Min/45 Min		
Delete alt.ver	1 Flash			
OTA confirm Time	90 Min	3 Min/90 Min		
OTA limit Time	3 Hour	3 Min/3Hour		
Dynamic CE	Off	On/Off		
FWC	Off	On/Off		
1080p 48Hz	On	On/Off		
PWM Max	100	1~100		
PWM Max2	95	1~100		
PWM Mid	10	0~10		
PWM Min	0	0~10		
COMP PHASW	110			
Quick Start				
DTV LNA	Auto	On/Off		
HDCP Download	Off	On/Off		
USB Download	Off	On/Off		
LED Peak OnOFF				
COLOR MAPPING				
WCE				
SHARPNESS				
ENHANCE				
LNA_Plus				
FCC				
PC_Picture				
FRC				
PQ OTHERS				

4. Troubleshooting

Factory Menu Name	Data	Range	Remark	Key
7.5 IRE NTSC	OFF	ON/OFF		
7.5 IRE OFFSET	16	0~60		
YC_Delay				
PAL BG	1	0~3		
PAL DK	1	0~3		
PAL I	1	0~3		
SECAM BG	4	0~3		
SECAM DK	4	0~3		
SECAML	4	0~3		
NTSC 358	1	0~3		
NTSC 443	0	0~3		
AV PAL	1	0~3		
AV SECAM	4	0~3		
AV NT358	1	0~3		
AV NT443	1	0~3		
AV PAL60	1	0~3		
EEPROM RESET				
EEPROM RESET	OFF	ON/OFF		
NVR ALL CLEAR	OFF	ON/OFF		

4-4. White Balance

4-4-1. Calibration

1. Into the Factory Mode.
2. Select **SVC** Menu.
3. Select **ADC/WB** menu.
4. Select **ADC** menu.



4-4-2. Service Adjustment

You must perform Calibration in the Lattice Pattern before adjusting the White Balance.

■ Color Calibration

- Adjust Specification

Source	Setting Mode	Pattern	Use Equipment
HDMI	1280 x 720@60 Hz	Pattern #24 (Chess Pattern)	CA210 & Master MSPG925 Generator

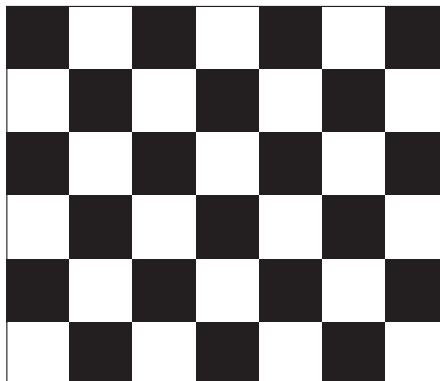

(Chess Pattern)

- Use other equipment only after comparing the result with that of the Master equipment.

Input mode	Calibration	Pattern
CVBS IN (Model_#1)	Perform in NTSC B&W Pattern #24	Lattice
Component IN (Model_#6)	Perform in 720p B&W Pattern #24	Lattice
PC Analog IN (Model_#21)	Perform in VESA XGA (1024x768) B&W Pattern #24	Lattice
HDMI IN	Perform in 720p B&W Pattern #24	Lattice

■ Method of Color Calibration (AV)

1. Apply the NTSC Lattice (N0. 3) pattern signal to the AV IN 1 port.
2. Press the Source key to switch to "AV1" mode.
3. Enter Service mode.
4. Select the "ADC" menu.
5. Select the "AV Calibration" menu.
6. In "AV Calibration Off" status, press the "▶" key to perform Calibration.
7. When Calibration is complete, it returns to the high-level menu.
8. You can see the change of the "AV Calibration" status from Failure to Success.

■ Method of Color Calibration (Component)

1. Apply the 720p Lattice (N0. 6) pattern signal to the Component IN 1 port.
2. Press the Source key to switch to "Component1" mode.
3. Enter Service mode.
4. Select the "ADC" menu.
5. Select the "Comp Calibration" menu.
6. In "Comp Calibration Off" status, press the "▶" key to perform Calibration.
7. When Calibration is complete, it returns to the high-level menu.
8. You can see the change of the "Comp Calibration" status from Failure to Success.

■ Method of Color Calibration (PC)

1. Apply the VESA XGA Lattice (N0. 21) pattern signal to the PC IN port.
2. Press the Source key to switch to "PC" mode.
3. Enter Service mode.
4. Select the "ADC" menu.
5. Select the "PC Calibration" menu.
6. In "PC Calibration Off" status, press the "▶" key to perform Calibration.
7. When Calibration is complete, it returns to the high-level menu.
8. You can see the change of the "PC Calibration" status from Failure to Success.

■ Method of Color Calibration (HDMI)

1. Apply the 720p Lattice (N0. 6) pattern signal to the HDMI1/DVI IN port.
2. Press the Source key to switch to "HDMI1" mode.
3. Enter Service mode.
4. Select the "ADC" menu.
5. Select the "HDMI Calibration" menu.
6. In "HDMI Calibration Off" status, press the "▶" key to perform Calibration.
7. When Calibration is complete, it returns to the high-level menu.
8. You can see the change of the "HDMI Calibration" status from Failure to Success.

4-4-3. Adjustment

1. Into the Factory Mode.
2. Select **SVC** Menu.
3. Select **ADC/WB** menu.
4. Select **White Balance** menu.

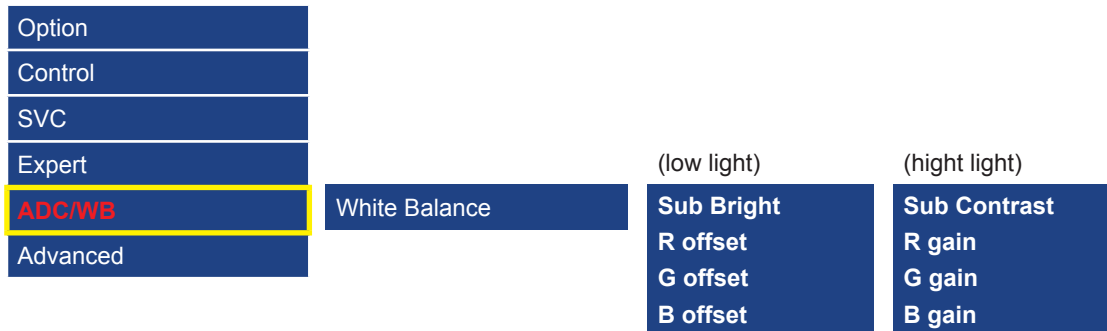

4-5. White Ratio (Balance) Adjustment

1. You can adjust the white ratio in factory mode (1:Calibration, 3:White-Balance).
2. Since the adjustment value and the data value vary depending on the input source, you have to adjust these in CVBS, Component 1 and HDMI 1 modes.
3. The optimal values for each mode are configured by default. It varies with Panel's size and Specification.
 - Equipment : CS-210
 - Pattern: MIK K-7256 #92 "Flat W/B Pattern" as standard
 - Alternate Equipment : CA200& anyone Master supported pattern#92(refer to right photo)
 - Use other Equipment only after comparing the result with that of the Master equipment.
 - Set Aging time : 60 min



Calibration and Manual setting for WB adjustment

- HDMI : Calibration at #24 Chessboard Pattern Manual adjustment at #92 pattern (720p)
- COMP: Calibration at #24 Chessboard Pattern Manual adjustment at #92 pattern (720p)
- CVBS: Calibration at #24 Chessboard Pattern Manual adjustment at #92 pattern (NTSC)



Note

If finishing in HDMI mode, adjustment coordinate is almost same in AV/COMP mode.

4-6. RS-232C

1. RS232C Control

- Port : COM#(Serial)
- Bit rate : 38400
- Data Bit : 8 bit
- Parity : None
- Stop Bits : 1
- Flow Control : None

2. Description of RS232C

Pin#	Name	Full Name
1	CD	Carrier Detect
2	RxD	Received Data
3	TxD	Transmitted Data
4	DTR	Data Terminal Ready
5	GND	Signal Ground
6	DSR	Data Set Ready
7	RTS	Request To Send
8	CTS	Clear To Send
9	RI	Ring Indicator

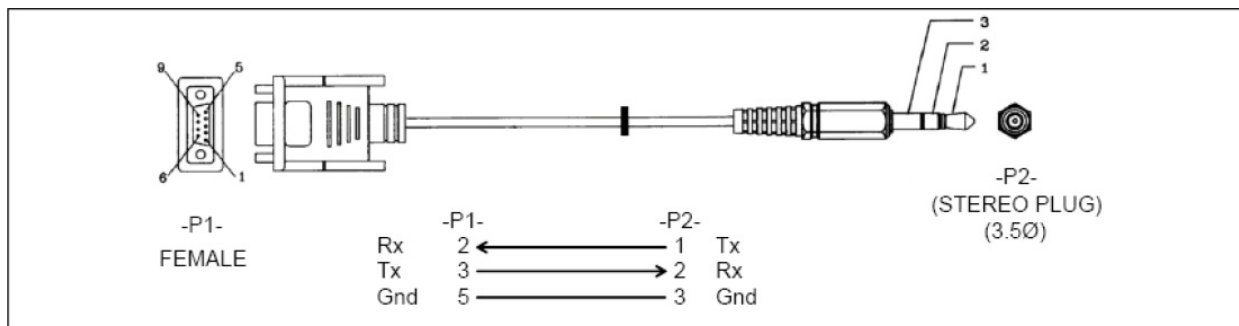

4-7. Software Upgrade

Software Upgrade can be performed by downloading the latest firmware from samsung.com to a USB memory device.

- Current Version - The software already installed in the TV.

Software is represented as 'Year/Month/Day_Version'.

4-7-1. How to Check the Software Version

■ Use the Main Menu

1. Click the "MENU" key in remote controller.
2. Select "Support" menu.
3. Locate the menu cursor "Software Upgrade" menu.
4. Click the "INFO" key.
 - Check the Main SW and Micom version.

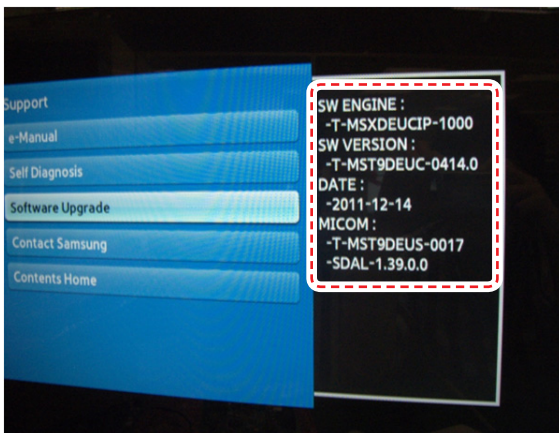

■ Use the Factory Mode

Option	T-MST0DEUC : SW Ver T-MST0DEUS : SW Ver
Control	EDID : SUCCESS
SVC	HDCP : SUCCESS
Expert	CALIB : AV / COMP / PC / HDMI /
ADC/WB	OPTION:**
Advanced	FactoryCS:***** T-MSXDEUCIP_**** Onboot : *** SDAL-**** RFS:Mstar-X9 **** 20**_**_**

4-7-2. How to Upgrade Software and Micom

Insert a USB drive containing the firmware upgrade downloaded from samsung.com into the TV. Please be careful not to disconnect the power or remove the USB drive while upgrades are being applied. The TV will turn off and turn on automatically after completing the firmware upgrade. Please check the firmware version after the upgrades are complete (the new version will have a higher number than the older version). When software is upgraded, video and audio settings you have made will return to their default (factory) settings. We recommend you write down your settings before beginning firmware update. After update is completed, restore your previous settings.

■ Main Software Upgrade

1. Store the sw program named "T-MST9DEU" in USB memory stick
 - Connect the USB.



2. Click the "MENU" key in Remote Controller.
3. Select "Support" menu.
Locate the menu cursor "Software Upgrade" menu.

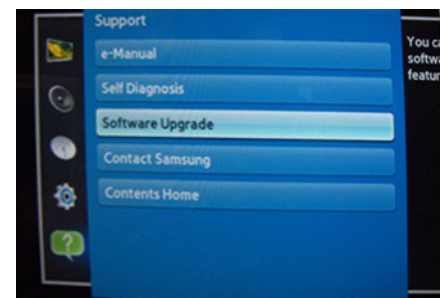

4. Locate the menu cursor "By USB" menu.

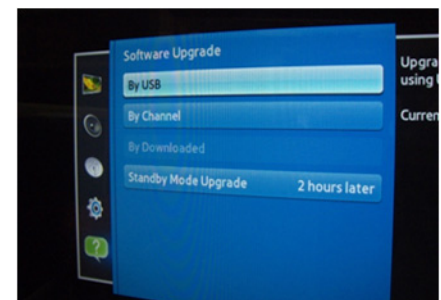

5. Click the "ENTER" key.

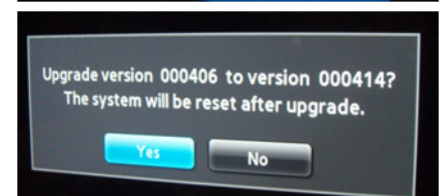

6. Click the "ENTER" key.
 - Wait for upgrade complete.
 - Check the Software Version.

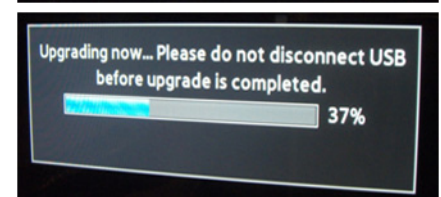

4-8. Cover-Middle Rear Dimension

■ UE32EH5****

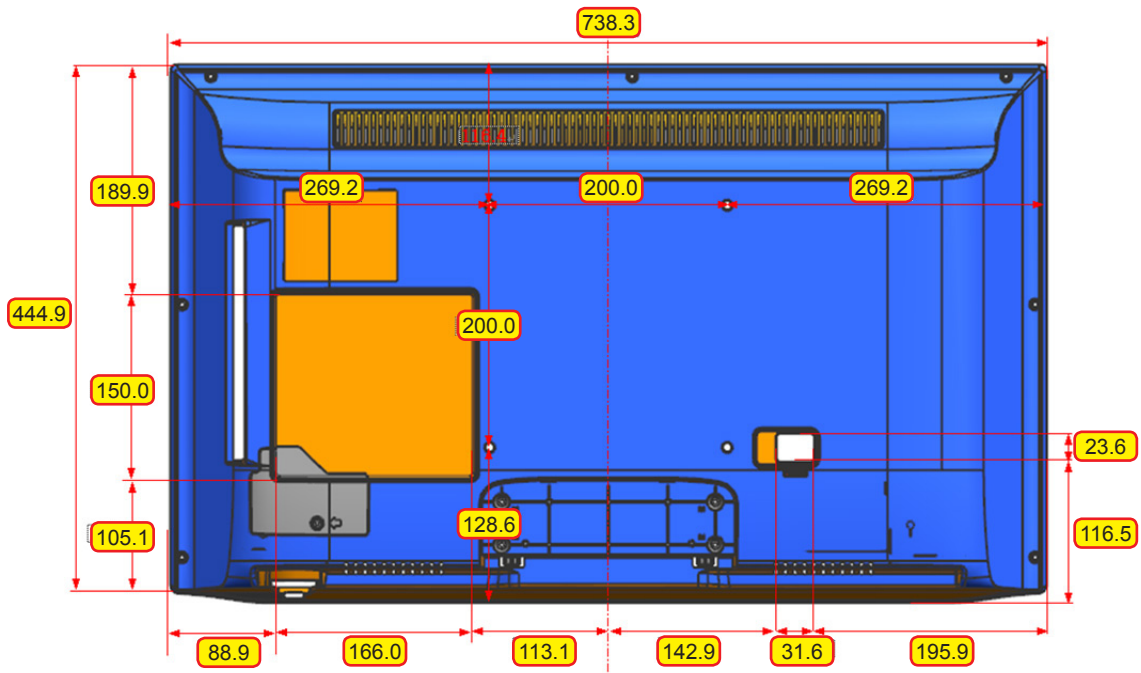

■ UE37EH5****

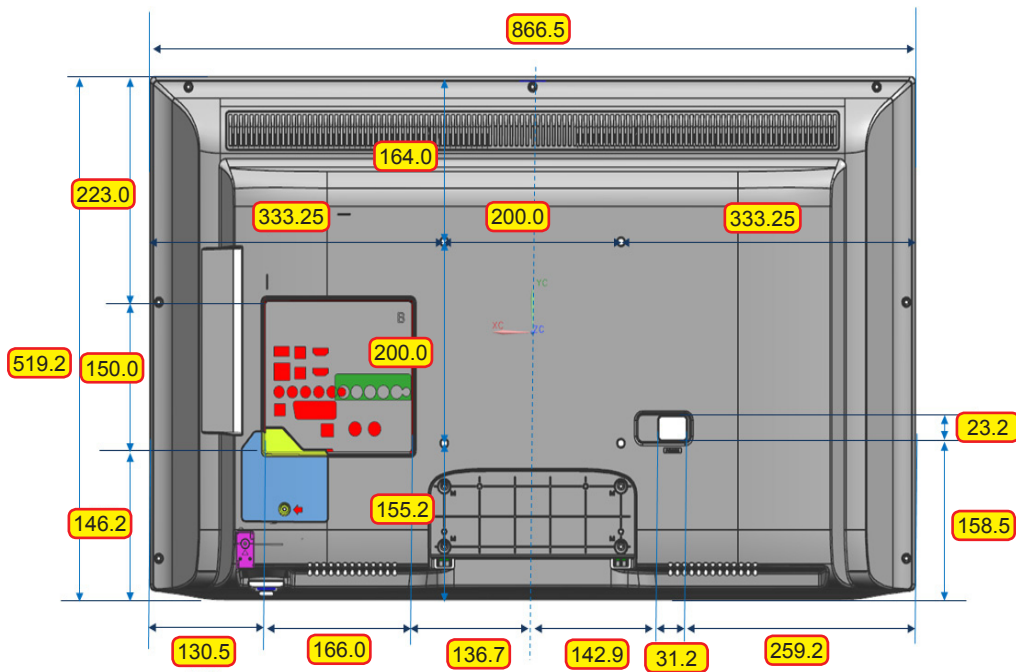

■ UE40EH5****

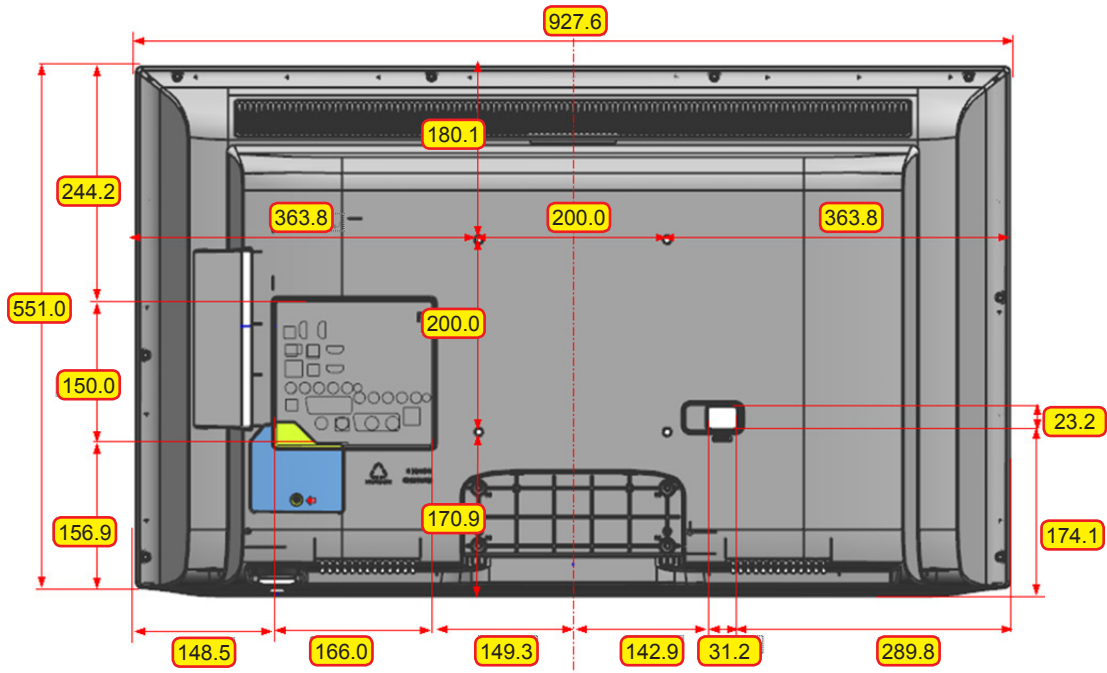

■ UE46EH5****

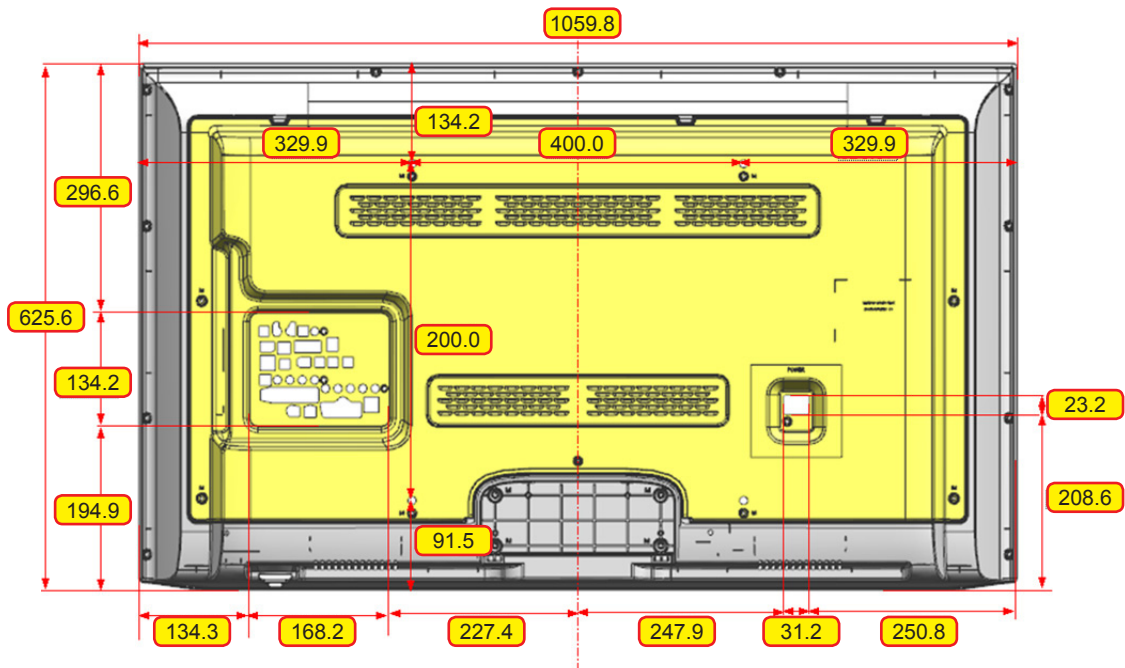

■ UE26EH4****

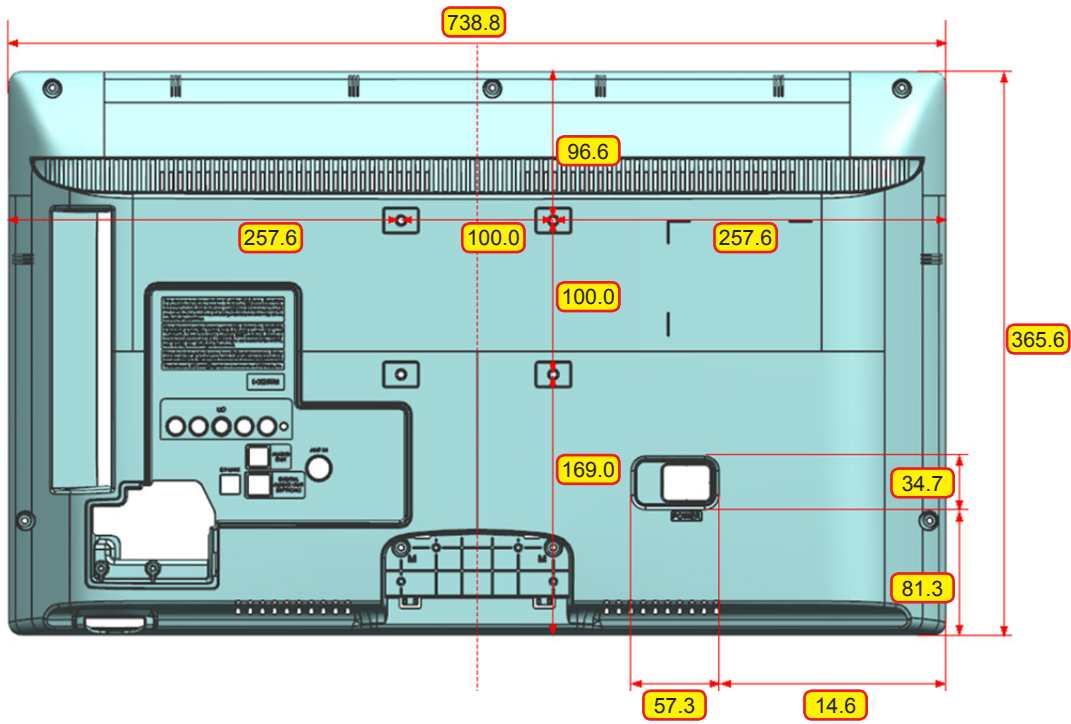

■ UE32EH4****

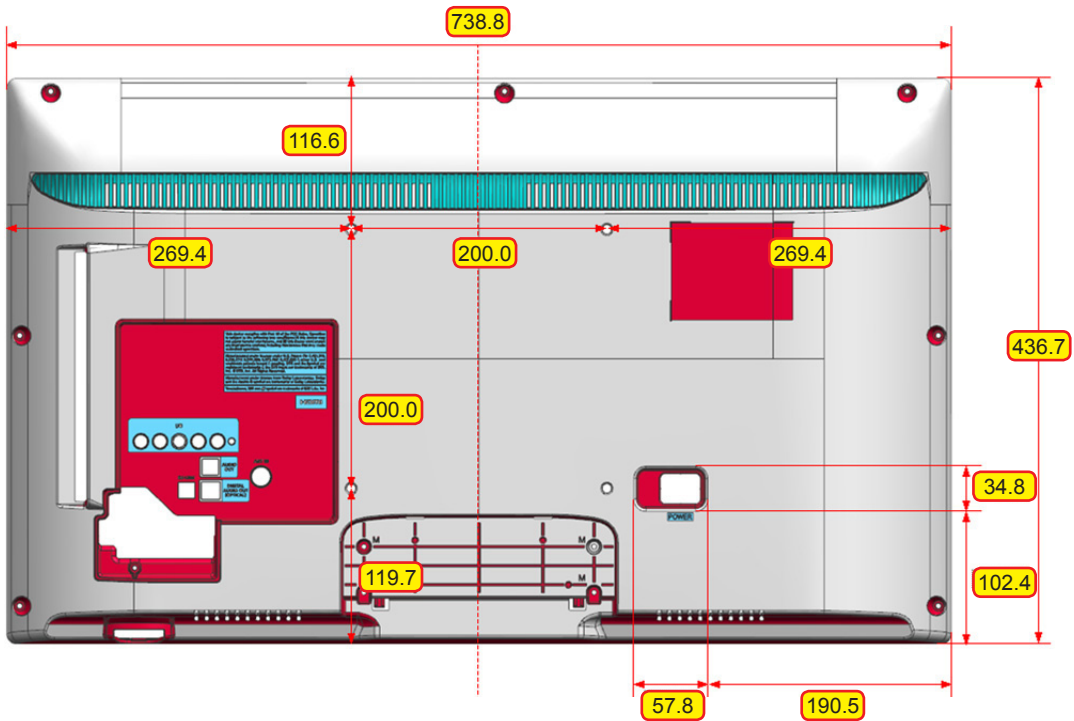

■ UE19ES4****

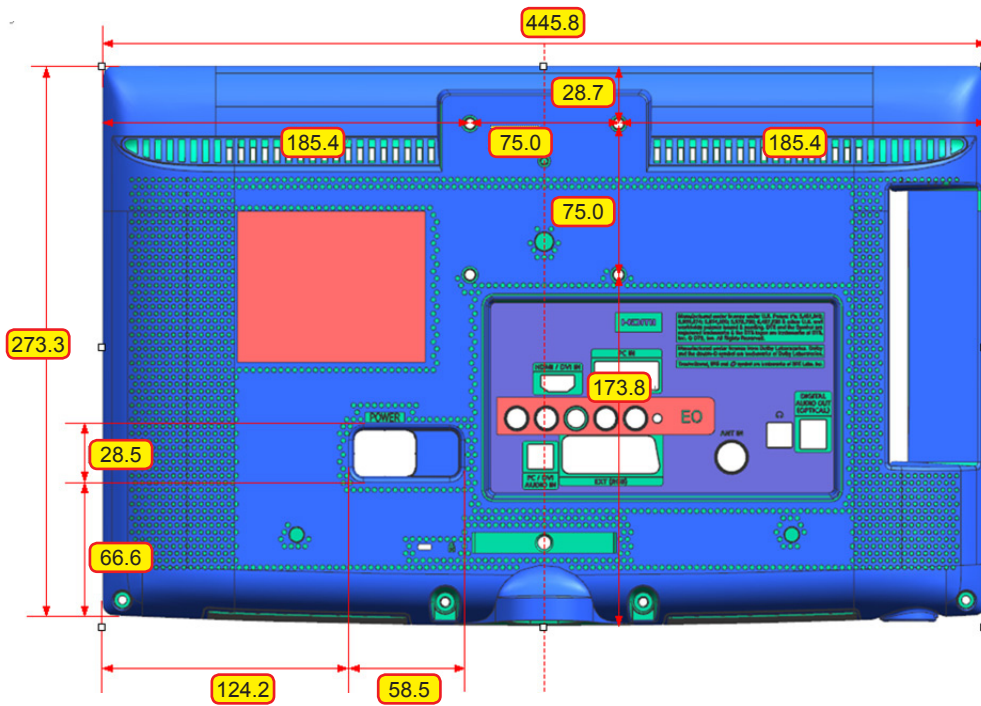

■ UE22ES5****

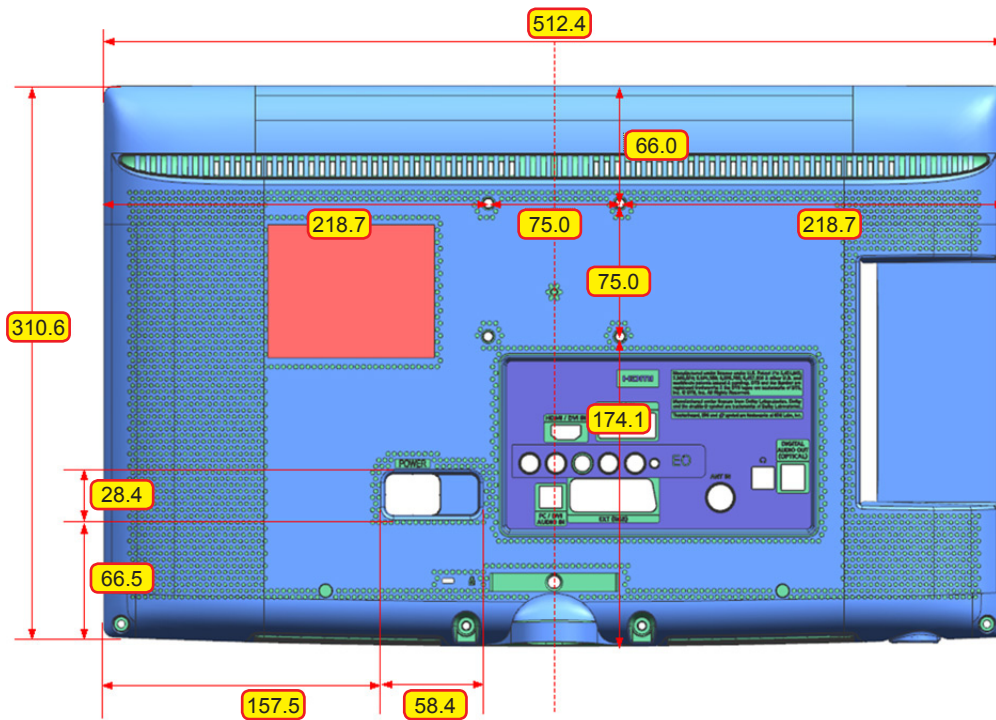

5. Wiring Diagram

5-1. Wiring Diagram

■ U71A_FHD

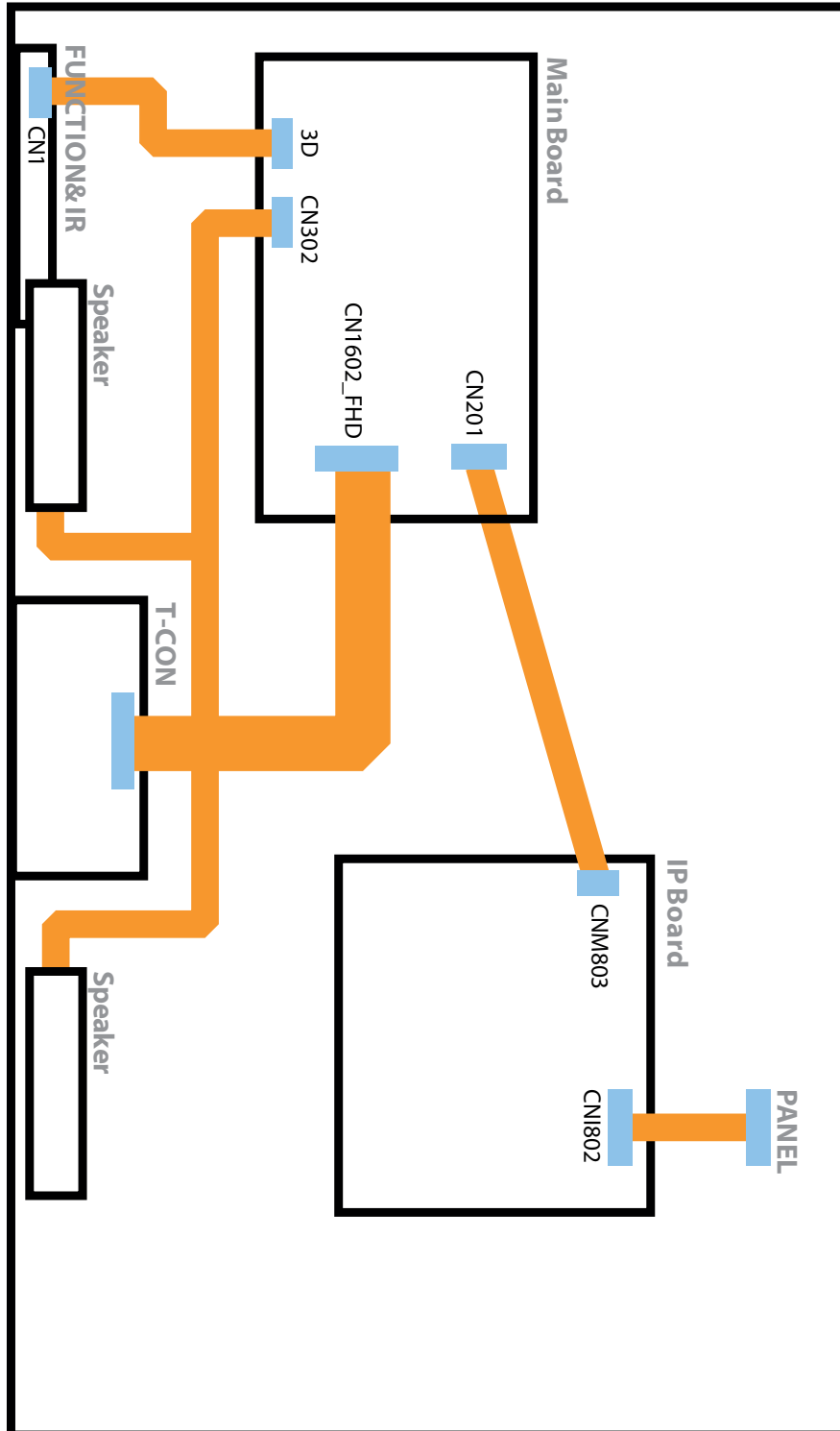

■ U71B_HD

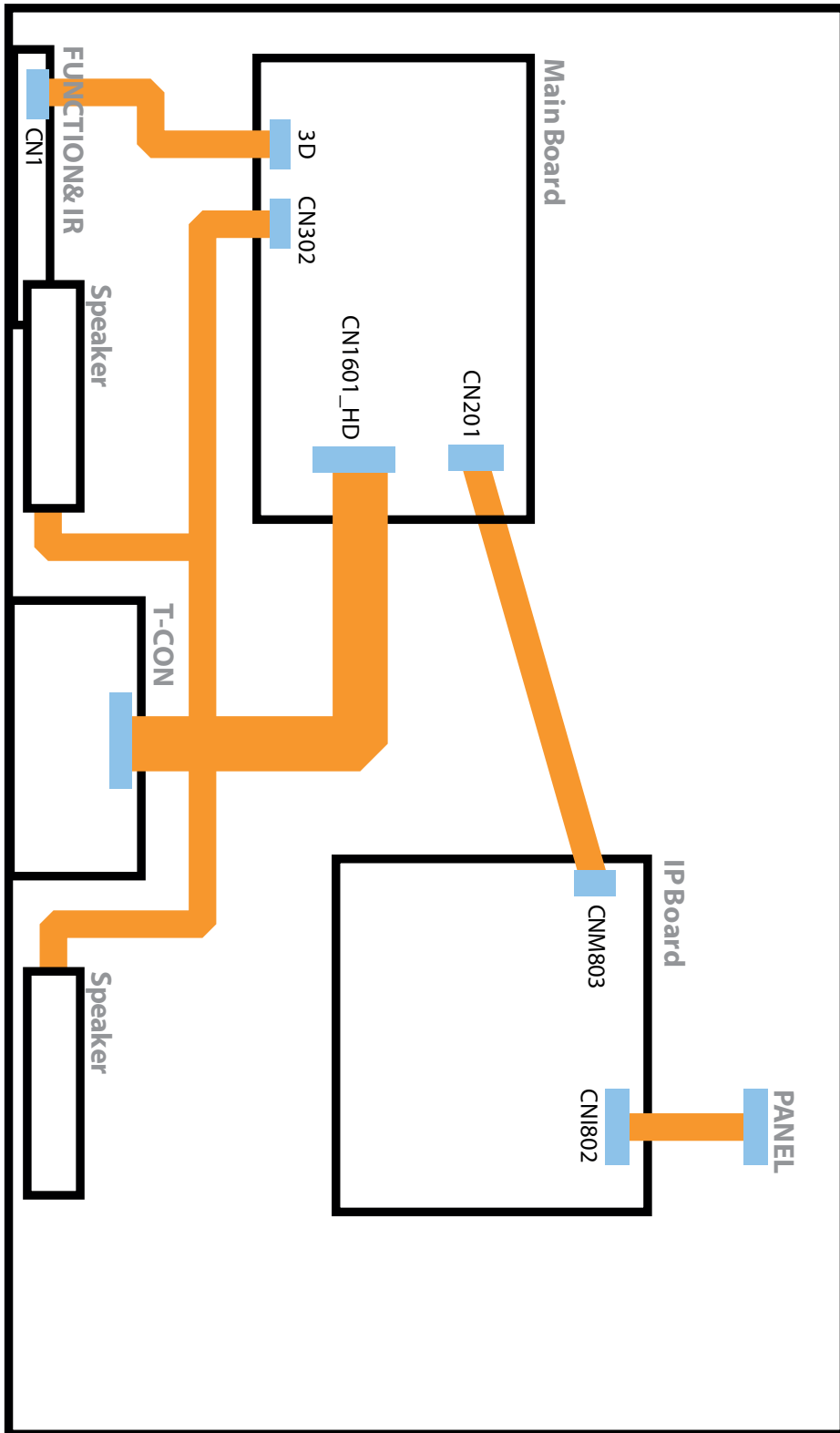

5-2. Connector

① CN1602_FHD (to Panel)_U71A			
1	NC	27	EVEN[0]-
2	NC	28	GND
3	NC	29	ODD[4]+
4	NC	30	ODD[4]-
5	NC	31	ODD[3]+
6	NC	32	ODD[3]-
7	FORMAT	33	GND
8	SDA_Panel	34	ODDCLK+
9	TCON_WP	35	ODDCLK-
10	NC	36	GND
11	SDA_Panel	37	ODD[2]+
12	SCL_Panel	38	ODD[2]-
13	GND	39	ODD[1]+
14	EVEN[4]+	40	ODD[1]-
15	EVEN[4]-	41	ODD[0]+
16	EVEN[3]+	42	ODD[0]-
17	EVEN[3]-	43	GND
18	GND	44	GND
19	EVENCLK+	45	GND
20	EVENCLK-	46	NC
21	GND	47	Panel_VCC
22	EVEN[2]+	48	Panel_VCC
23	EVEN[2]-	49	Panel_VCC
24	EVEN[1]+	50	Panel_VCC
25	EVEN[1]-	51	Panel_VCC
26	EVEN[0]+		

② CN201 (to Powr board)			
1	B5V	8	GND
2	SW_POWER	9	B13VS
3	B5V	10	SW_INVERTER
4	A5V	11	B13V
5	GND	12	B13V
6	GND	13	B13V
7	B13VS	14	PWM_DIMM

③ CN1202_N3D (FUNCTION)			
1	IR	5	MSDA
2	GND	6	KEY1
3	A3.3V	7	KEY2
4	MSCL	8	GND

④ CN302 (SPEAKER)			
1	R+	3	L+
2	R-	4	L-

⑤ CN503_FPC(DEBUG)			
1	GND	4	DEBUG_TX
2	DEBUG_RX	5	DEBUG_TX
3	DEBUG_TX	6	GND

⑥ CN502(COMPONETN)			
1	GND	9	GND
2	COMP1_Y	10	GND
3	IDENT_AV	11	SL
4	GND	12	SR
5	PB	13	GND
6	IDENT_COMP	14	SR
7	GND	15	SL
8	PR		

⑦ CN501 (HDMI1)			
1	HDMI1_RX2+	11	GND
2	GND	12	HDMI1_RXCLK-
3	HDMI1_RX2-	13	HDMI_CEC
4	HDMI1_RX1+	14	GND
5	GND	15	SCL
6	HDMI1_RX1-	16	SDA
7	HDMI1_RX0+	17	GND
8	GND	18	5V
9	HDMI1_RX0-	19	HPD
10	HDMI1_RXCLK+		

⑧ CN502 (HDMI2)			
1	HDMI2_RX2+	11	GND
2	GND	12	HDMI2_RXCLK-
3	HDMI2_RX2-	13	HDMI_CEC
4	HDMI2_RX1+	14	GND
5	GND	15	SCL
6	HDMI2_RX1-	16	SDA
7	HDMI2_RX0+	17	GND
8	GND	18	5V
9	HDMI2_RX0-	19	HPD
10	HDMI2_RXCLK+		

5. Wiring Diagram

⑨ CN1201 (USB1)			
1	USB_VCC	3	USB_DP
2	USB_DM	4	GND

⑩ CN1201 (USB1)			
1	SPDIF_OUT	3	GND
2	GND		

⑪ CN301(MONITOR OUT)			
1	GND	4	GND
2	SR_OUT	5	NC
3	SL_OUT	6	GND

① CN1601_HD (to Panel)_U71B			
1	PANEL_VCC	16	ODD_CLK+
2	PANEL_VCC	17	ODD_CLK-
3	PANEL_VCC	18	GND
4	PANEL_VCC	19	ODD2+
5	PANEL_VCC	20	ODD2-
6	GND	21	GND
7	GND	22	ODD1+
8	GND	23	ODD1-
9	WP_PANEL	24	GND
10	LVDS FORMAT	25	ODD0+
11	NC	26	ODD0-
12	GND	27	GND
13	ODD3+	28	SDA
14	ODD3-	29	SCL
15	GND	30	NC

5-3. Connector Functions

■ U71A_FHD

Connector	Function
CN201 ↔ IP CNM803	Supply main power and dimming signal from IP board to Main Board.
CN1301_FHD ↔ T-CON CNF1	The LVDS signal transferred from Main Board to Panel.

■ U71B_HD

Connector	Function
CN201 ↔ IP CNM803	Supply main power and dimming signal from IP board to Main Board.
CN1302_HD ↔ T-CON CNF1	The LVDS signal transferred from Main Board to Panel.

5-4. Cables

■ 5000

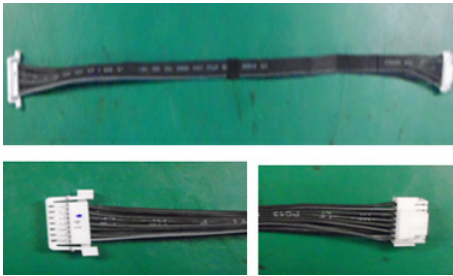
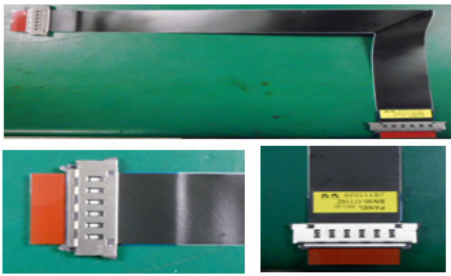
Use	LEAD (Main-IP 14P)	LVDS CALBE (Main - Panel 30P)
Code No.	22" : BN39-01449T 32" : BN39-01449C 37" : BN39-01449B 40" : BN39-01449Q 46" : BN39-01449S	22" : BN96-20370B 32" : BN96-17116V 37" : BN96-23839F 40" : BN96-17116W 46" : BN96-17116X
Image		

■ 4000

Code No.	19" : BN39-01449T 26" : BN39-01449N 32" : BN39-01449C	19" : BN96-20370E 26" : BN96-20370D 32" : BN96-20370C
Image		

1. Exploded View & Part List

Exploded View

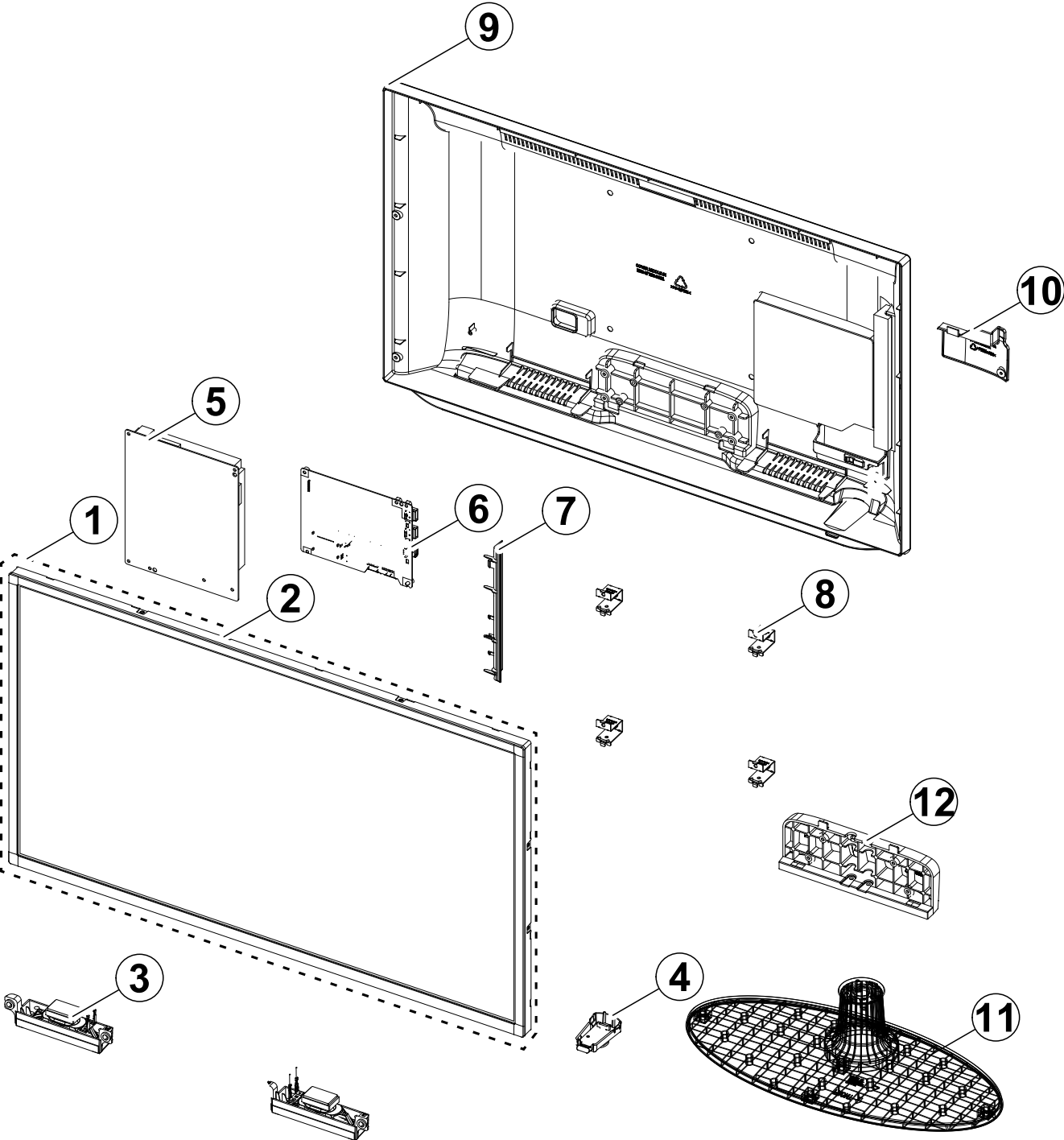

Parts List

No.	Lvl.	Loc.	Material Code	Description & Specification	SNA	Qty.
1	2	PANEL	BN95-00713A	PRODUCT LCD-SHARP; 40inch, 60Hz, 2D, DE40	SA	1
2	3	TC01A	BN96-21617B	ASSY MISC P-CHASSIS TOP; Y12 Full LED, 40	SA	1
3	2	SP01A	BN96-21669B	ASSY SPEAKER P; 6ohm,4pin,10W,Enclosure t	SA	1
4	2	FB01A	BN96-22413B	ASSY BOARD P-JOG SWITCH & IR; UN40E5000,F	SA	1
5	2	P001A	BN44-00496A	DC VSS-LED TV PD BD; PD40AVF_CSM,PSLF760C	SA	1
6	2	M0014	BN94-06144S	ASSY PCB MAIN; UE40EH5020WXXH	SA	1
7	3		BN61-07946A	HOLDER-SIDE, AV; UE4000,26/32/40,EO,HIPS,	SNA	1
8	2	CB20	BN61-07952A	BRACKET-WALL; UE5000 40",EGI-SECC PL,T1.2	SNA	4
9	2		BN96-24871A	ASSY COVER P-MIDDLE REAR; UE40EH5000,,PC+	SA	1
10	3	FC05	BN63-09202G	COVER-JACK; 5000,40,ABS+PC,-,-,-,-,-,-,-,-,-,-,	SNA	1
11	2	SB04A	BN96-21736G	ASSY STAND P-BASE; UE5300,40/46,EO,PC/ABS	SA	1
12	2	SG01A	BN96-21742C	ASSY GUIDE P-STAND; UE5000,40/46/55,W/W,P	SA	1

2. Electrical Parts List

Level	Loc.	Part Code	Description & Specification	Qty.	SA/SNA
			UE40EH5020WXXH (HS02)		
1		BN90-03824B	ASSY COVER MIDDLE-REAR;UEH5000,40,EO	1	SNA
.2		6001-002755	SCREW-MACHINE;BH,+,M3,L6,ZPC(BLK),SWRCH1	4	SA
.2	SCREW	6003-001782	SCREW-TAPTYPE;BH,+,B,M4,L12,ZPC(BLK),SWR	9	SA
.2		BN96-24871A	ASSY COVER P-MIDDLE REAR;UE40EH5000,,PC+	1	SA
..3		BN63-07556T	COVER-SHEET;TOC,urethane,T0.068,W22mm,10	2	SNA
..3		BN63-09080B	COVER-MIDDLE REAR;UE5000 40,EO,PC+ABS G/	1	SNA
...4		0103-009559	RESIN-PC;210GNH15,6919A,BK0007,PC ABS GF	2200	SNA
..3	FC05	BN63-09202G	COVER-JACK;5000,40,ABS+PC,-,-,-,-,-,-,-,-,-,-	1	SNA
..3	T0071	BN64-01951A	INLAY-TERMINAL;UE4000-26/32/40,PS SHEET,	1	SNA
1	S001A	BN90-03831V	ASSY STAND;UEH5300,40/46,EO	1	SNA
.2	SB04A	BN96-21736G	ASSY STAND P-BASE;UE5300,40/46,EO,PC/ABS	1	SA
..3	SCREW	6003-001782	SCREW-TAPTYPE;BH,+,B,M4,L12,ZPC(BLK),SWR	3	SA
..3	SCREW	6003-001785	SCREW-TAPTYPE;FH,+,B,M4,L8,ZPC(BLK),SWRC	6	SA
..3		BN61-04692A	BOSS-PRIMER;#94,clear,35cps	0	SNA
..3	SG01	BN61-08036A	GUIDE-STAND NECK;UE5000,40,PC+G/F 20%,V2	1	SNA
..3		BN61-08105A	BRACKET-STAND BOTTOM;UE5000 40/46",EGI-S	1	SNA
..3	CCM1	BN63-02183D	COVER-SHEET;RhcM,PE Vinyl,T0.05,680mm,20	1	SNA
..3		BN63-09084B	COVER-STAND, BASE;UE5000,40/46,EO,ABS+PC	1	SNA
...4		0103-005041	RESIN-PC;FR3200TV,901408,BK0008,1.2mm V-	560	SNA
..3		BN67-00327D	RUBBER-FOOT;STAND,SILICON,13*13,T2,GRAY(7	SNA
.2	SG01A	BN96-21742C	ASSY GUIDE P-STAND;UE5000,40/46/55,W/W,P	1	SA
..3	T0524	6902-001063	BAG PE;LDPE,T0.05,W180,L350,TRP,RECYCLE	1	SNA
..3	SG03	BN61-07941A	GUIDE-STAND;UE5000/6000,40/46/55,W/W,PC+	1	SNA
...4		0103-007285	RESIN-PC;MW32020GFU,K032202GFV,BK0007,V2	260	SNA
...4		BN68-00513D	LABEL-RESIN;resin,-,art paper,-,10,25,-,	1	SNA
..3		BN68-04027C	MANUAL FLYER-03,STAND GUIDE;U4000(32),SA	1	SNA
..3		BN96-18013E	ASSY ACCESSORY-SCREW;6003-001782,4EA,ALL	2	SNA
...4	SCREW	6003-001782	SCREW-TAPTYPE;BH,+,B,M4,L12,ZPC(BLK),SWR	8	SA
...4		BN69-05418B	PACKING-BAG SCREW;BN96-18013E,CB,-,GREEN	2	SNA
1		BN91-07065F	ASSY SHIELD;UE5L,E5000	1	SNA
.2		6001-002756	SCREW-MACHINE;BH,+,M3,L6,ZPC(WHT),SWRCH1	13	SA
.2		BN02-00102B	TAPE FILAMENT;UE7000,#893,0.15,25,50,WHI	0	SNA
.2	EC13	BN39-01449Q	LEAD CONNECTOR;UN32D5000FXZA,Falt Connec	1	SA
.2	P001A	BN44-00496A	DC VSS-LED TV PD BD;PD40AVF_CSM,PSLF760C	1	SA
.2	CB20	BN61-07952A	BRACKET-WALL;UE5000 40",EGI-SECC PL,T1.2	4	SNA
.2	FL06	BN96-17116W	ASSY CABLE P-FFC;UN40EH5000,FFC,324mm,51	1	SA
.2	SP01A	BN96-21669B	ASSY SPEAKER P;6ohm,4pin,10W,Enclosure t	1	SA

Exploded Views and Parts List

Level	Loc.	Part Code	Description & Specification	Qty.	SA/SNA
.2	FB01A	BN96-22413B	ASSY BOARD P-JOG SWITCH & IR;UN40E5000,F	1	SA
1		BN91-09485A	ASSY LCM-SHARP;BN95-00713A	1	SNA
.2	PANEL	BN95-00713A	PRODUCT LCD-SHARP;40inch, 60Hz, 2D, DE40	1	SA
...3		6001-002757	SCREW-MACHINE;BH,+,M3,L4,ZPC(WHT),SWRCH1	3	SA
...3		BN02-00043C	TAPE ETC-SHEET FIXING;F-LED 32/40/46,3M	3	SNA
...3		BN63-03740A	GASKET-EMI;50P9,Fabric Tape,0.1mm,20mm,	4	SNA
...3		BN63-09395B	COVER-T CON;Y12 F-LED (60Hz/120Hz),CC105	1	SNA
...3		BN68-02471A	LABEL-STICKER;WW,Art Paper,80,40,AV	1	SNA
...3		BN82-01228A	A/S ASSY-FPC CABLE;DFR,59mm,80P FPC CABL	2	SNA
...3		BN90-04089A	ASSY MISC-BLU;Sharp 40inch 60Hz	1	SNA
...4		BN61-07891A	SUPPORT-PLATE;Y12 FULL LED,PC,CLEAR	2	SNA
...4		BN61-08058A	LGP-DIFFUSER PLATE;40" Diffuser Plate,P	1	SNA
...4		BN63-09221A	SHEET-REFLECTOR;40",F-LED, SY70 188,SHE	1	SNA
...4		BN63-09484A	SHEET-DIFFUSER;40inch DLED UTE24B-10E(6)	1	SNA
...4		BN63-09485A	SHEET-DIFFUSER;40inch DLED UTE24B-10B(0)	1	SNA
...4		BN96-21613C	ASSY MISC P-CHASSIS BOTTOM;Y12 Full LED	1	SNA
....5		BN02-00094A	TAPE PET;Y12 F-LED,MT-PFR,T 0.05,W30,L40	1	SNA
....5		BN02-00102B	TAPE FILAMENT;UE7000,#893,0.15,25,50,WHI	1	SNA
....5	EC13	BN39-01588A	LEAD CONNECTOR;40" Direct wire-harness,F	1	SNA
....5		BN61-08161A	HOLDER-LED-PCB;Direct-LED,PC,white	2	SNA
....5	CC02	BN64-01896C	CHASSIS-BOTTOM;Y12 F-LED 40" _H-SLIDE,EGI	1	SNA
....5		BN96-21486A	ASSY MISC P-SUB PCB;40" Sub PCB,2pin*5ea	1	SNA
...4		BN96-23797B	ASSY FRAME P-MOLD MIDDLE U;Y12 F-LED,40"	1	SNA
....5		BN60-00453D	SPACER-PANEL (UD);F-LED 40" SHARP,MGT-3	2	SNA
....5		BN60-00454D	SPACER-PANEL (LR);F-LED 40" SHARP,MGT-3	2	SNA
....5		BN60-00606A	SPACER-RUBBER;F-LED 40" SHARP,SH0140U+AT	2	SNA
....5		BN61-08464A	FRAME-MOLD MIDDLE;Y12 F-LED 40",PC+GF,BI	1	SNA
...4		BN96-24136A	ASSY MISC P-LED BAR;40" _Direct_Sharp_Lef	5	SNA
...4		BN96-24137A	ASSY MISC P-LED BAR;40" _Direct_Sharp_Rig	5	SNA
...3	TC01A	BN96-21617B	ASSY MISC P-CHASSIS TOP;Y12 Full LED, 40	1	SA
...4	T0069	AA63-60122K	SPACER-FELT;SPD-42P3S,FELT,L60,D20,T0.35	4	SNA
...4		BN60-00446A	SPACER-GASKET;Full-LED,FG200A,L25,t0.2,W	4	SNA
...4		BN60-00451A	SPACER-TOP (UD);Full-LED 40",FG200A,L90	2	SNA
...4		BN60-00452A	SPACER-TOP (LR);Full-LED 40",FG200A,L52	2	SNA
...4		BN60-00473B	SPACER-BLOCK;F-LED 40",MTU-R,889,BLK,T	1	SNA
...4		BN63-07229T	COVER-SHEET;Y12 F-LED,SILICONE,T0.052,W	4	SNA
...4	AC157	BN64-01901B	CHASSIS-TOP;Y12 F-LED 40",PC+ABS+G/F15%,	1	SNA
...3		BN96-23705A	ASSY OPEN CELL;LK400D3HB7K,0.46125(H)X0.	1	SNA
...4		BN81-07744A	A/S PART-SOURCE IC;DRIVER IC,VHIS6C277G2	1	SNA
...4		BN81-07745A	A/S PART-GATE IC;GATE IC,VHILH163Y02-1L,	1	SNA

Level	Loc.	Part Code	Description & Specification	Qty.	SA/SNA
...4		BN81-07746A	A/S PART-SOURCE PCB RIGHT;SOURCE PCB ASS	1	SNA
...4		BN81-07747A	A/S PART-SOURCE PCB LEFT;SOURCE PCB ASSY	1	SNA
...4		BN81-07775A	A/S PART-C/F POL;POL_C/F,PFILV1638TPZZ,S	1	SNA
...4		BN81-07776A	A/S PART-TFT POL;POL_TFT,PFILV1639TPZZ,P	1	SNA
..3	TCON	BN96-23812A	ASSY T CON P;LE400BGS-V1,150*50*1T,FHD 6	1	SA
1	M0017	BN91-10127S	ASSY CHASSIS;UE40EH5020WXXH	1	SNA
..2	M0014	BN94-06144S	ASSY PCB MAIN;UE40EH5020WXXH	1	SA
..3		0202-001608	SOLDER-WIRE FLUX;LFC7-107,D0.8,99.3Sn/0.	0	SNA
..3		BN61-07946A	HOLDER-SIDE, AV;UE4000,26/32/40,EO,HIPS,	1	SNA
...4		0103-009565	RESIN-MPPE;ST855,1D129A,BK0020	20	SNA
..3		BN67-00364A	RUBBER;UE32EH5000,RUBBER,10X10,9T,10X10	1	SNA
..3		BN97-05369W	ASSY SMD;UE5L,E5000	1	SNA
...4		0202-001899	SOLDER-CREAM;M705-GRN360-K2-VT,25-36um,S	7	SNA
...4	DS01A	0401-001056	DIODE-SWITCHING;MMBD4148SE,100V,200mA,SO	1	SA
...4		0403-001785	DIODE-ZENER;NZH5V1B,4.94/5.2V,500mW,SOD-	1	SA
...4		0403-001797	DIODE-ZENER;NZH3V0B,2.85/3.15V,500mW,SOD	1	SNA
...4	D0254	0404-001404	DIODE-SCHOTTKY;BAT721C,40V,200mA,SOT-23,	1	SA
...4	SD3	0407-000114	DIODE-SWITCHING;KDS184,80V,100mA,SOT-23,	1	SNA
...4	KQ1	0501-000279	TR-SMALL SIGNAL;KSA1182-Y,PNP,150mW,SOT-	1	SA
...4	Q101	0501-000445	TR-SMALL SIGNAL;KTC3875S-Y,NPN,150mW,SOT	8	SC
...4	CEQ2	0505-000110	FET-SILICON;2N7002,N,60V,115mA,7.5ohm,0.	2	SA
...4	Q409	0505-002560	FET-SILICON;AO6415,P,-20V,-3.3A,0.15ohm,	1	SA
...4	IC104	0801-002630	IC-CMOS LOGIC;74AHCT1G08,2-INPUT AND GAT	1	SA
...4	ND51C2	0801-002780	IC-CMOS LOGIC;74LVC1G17,SCHMITT-TRIGGER	1	SA
...4	IC104	0801-003330	IC-CMOS LOGIC;Octal buffer,DQFN,20P,4.5x	2	SA
...4	IC104	0802-001012	IC-CMOS LOGIC;74LCX245,TRANSCEIVER,DQFN,	1	SNA
...4	IC112	1103-001310	IC-EEPROM;2Kbit,256x8,SOIC,8Z30,5x4mm,2.	3	SNA
...4		1103-001531	IC-EEPROM;S-24C256CI-J8T1U4,256Kbit,32Kx	1	SA
...4		1105-002194	IC-DDR3 SDRAM;K4B1G1646G-BCH9,DDR3 SDRAM	2	SA
...4		1201-003183	IC-AUDIO AMP;DRV612,HTSSOP,14P,5x4.4mm,D	1	SA
...4		1201-003333	IC-POWER AMP;NTP-7412S,MLF,48P,7x7mm,DUA	1	SA
...4		1203-004364	IC-VOL. DETECTOR;RT9818C-42PV,SOT-23,3P,	1	SA
...4		1203-006017	IC-VOL. DETECTOR;RT9824GJ8,TSOT23,8P,2.9	1	SA
...4	T0087	1203-006109	IC-POSI.FIXED REG.;S-1206B33-M3T1G,SOT-2	1	SA
...4	T0087	1203-006130	IC-POSI.FIXED REG.;S-1172B25-U5T1G,SOT-8	1	SA
...4	T0087	1203-006135	IC-POSI.FIXED REG.;AP1117D-33-GZ-13-89,T	1	SA
...4	T0087	1203-006136	IC-POSI.FIXED REG.;AP1117D-18-GZ-13-89,T	1	SA
...4	IC012	1203-006138	IC-POSI.ADJUST REG.;AP1117DGZ-13-89,TO-2	1	SA
...4		1203-006710	IC-DC/DC CONVERTER;RT8016L-GQW,WQFN,8P,1	2	SA
...4		1203-007080	IC-DC/DC CONVERTER;AOZ1051PI,SO-8,8P,4.9	2	SA

Exploded Views and Parts List

Level	Loc.	Part Code	Description & Specification	Qty.	SA/SNA
...4		1204-003313	IC-DECODER;SEMS23,LFBGA,568P,20.2x20.2mm	1	SA
...4		1405-001271	VARISTOR;35V,20Vdc,5A,1.0x0.5x0.6mm,TP,1	9	SA
...4	MR604	2007-000137	R-CHIP;2Kohm,5%,1/16W,TP,1005	8	SNA
...4	R105	2007-000138	R-CHIP;100ohm,5%,1/16W,TP,1005	21	SA
...4	AVR73	2007-000142	R-CHIP;2.7Kohm,5%,1/16W,TP,1005	1	SNA
...4	R319	2007-000143	R-CHIP;4.7Kohm,5%,1/16W,TP,1005	38	SNA
...4	R104	2007-000148	R-CHIP;10Kohm,5%,1/16W,TP,1005	36	SA
...4	MR36	2007-000153	R-CHIP;22Kohm,5%,1/16W,TP,1005	7	SNA
...4	MR13	2007-000157	R-CHIP;47Kohm,5%,1/16W,TP,1005	7	SNA
...4	R123	2007-000159	R-CHIP;56Kohm,5%,1/16W,TP,1005	1	SNA
...4	DR39	2007-000162	R-CHIP;100Kohm,5%,1/16W,TP,1005	4	SNA
...4	MR16	2007-000168	R-CHIP;470Kohm,5%,1/16W,TP,1005	1	SNA
...4	HDR17	2007-000172	R-CHIP;10ohm,5%,1/16W,TP,1005	2	SNA
...4	R338	2007-000173	R-CHIP;22ohm,5%,1/16W,TP,1005	1	SNA
...4	UR23	2007-000174	R-CHIP;47ohm,5%,1/16W,TP,1005	2	SNA
...4	VR8	2007-000256	R-CHIP;1.6Kohm,1%,1/10W,TP,1608	1	SA
...4	R809	2007-000475	R-CHIP;1Mohm,1%,1/10W,TP,1608	3	SA
...4	S0F0522	2007-000691	R-CHIP;3.3Mohm,5%,1/10W,TP,1608	1	SA
...4	R726	2007-000695	R-CHIP;3.3ohm,5%,1/10W,TP,1608	4	SNA
...4	R124	2007-000775	R-CHIP;33Kohm,5%,1/16W,TP,1005	2	SNA
...4	R2007	2007-000803	R-CHIP;36Kohm,1%,1/10W,TP,1608	1	SA
...4	HR10	2007-000962	R-CHIP;5.1Kohm,1%,1/10W,TP,1608	1	SA
...4		2007-001285	R-CHIP;5.6ohm,5%,1/16W,TP,1005	2	SA
...4	OTR1	2007-001292	R-CHIP;33ohm,5%,1/16W,TP,1005	24	SNA
...4	DR43	2007-001298	R-CHIP;51ohm,5%,1/16W,TP,1005	2	SNA
...4	DR1	2007-001301	R-CHIP;68ohm,5%,1/16W,TP,1005	7	SA
...4	R16	2007-001313	R-CHIP;330ohm,5%,1/16W,TP,1005	2	SNA
...4	R326	2007-001325	R-CHIP;3.3Kohm,5%,1/16W,TP,1005	1	SNA
...4		2007-001333	R-CHIP;18Kohm,5%,1/16W,TP,1005	4	SNA
...4	PR24	2007-002970	R-CHIP;56ohm,5%,1/16W,TP,1005	4	SA
...4	HDR8	2007-007095	R-CHIP;390ohm,5%,1/16W,TP,1005	1	SA
...4		2007-007138	R-CHIP;27Kohm,1%,1/16W,TP,1005	1	SNA
...4	DR4	2007-007142	R-CHIP;10Kohm,1%,1/16W,TP,1005	4	SNA
...4		2007-007156	R-CHIP;1ohm,5%,1/16W,TP,1005	10	SNA
...4		2007-007313	R-CHIP;6.8Kohm,1%,1/16W,TP,1005	2	SA
...4		2007-007318	R-CHIP;1Kohm,1%,1/16W,TP,1005	24	SNA
...4		2007-007352	R-CHIP;130Kohm,1%,1/10W,TP,1608	2	SA
...4		2007-007463	R-CHIP;1.1Kohm,1%,1/16W,TP,1005	1	SA
...4		2007-007517	R-CHIP;240ohm,1%,1/16W,TP,1005	2	SNA
...4	MR11	2007-008015	R-CHIP;75ohm,1%,1/16W,TP,1005	9	SNA

Level	Loc.	Part Code	Description & Specification	Qty.	SA/SNA
...4		2007-008275	R-CHIP;30Kohm,1%,1/16W,TP,1005	2	SNA
...4		2007-008649	R-CHIP;220ohm,1%,1/16W,TP,1005	1	SNA
...4		2007-008779	R-CHIP;0ohm,1%,1/16W,TP,1005	6	SA
...4	DRP29	2011-000515	R-NETWORK;4.7Kohm,5%,1/16W,L,CHIP,8P,TP,	1	SA
...4	ZRN10	2011-001261	R-NETWORK;33ohm,5%,1/16W,L,CHIP,8P,TP,2.	6	SA
...4	DAR09	2011-001262	R-NETWORK;22ohm,5%,1/16W,L,CHIP,8P,TP,2.	5	SA
...4		2011-001264	R-NETWORK;10ohm,5%,1/16W,L,CHIP,8P,TP,2.	4	SNA
...4	HRP2	2011-001344	R-NETWORK;100ohm,5%,1/16W,L,CHIP,8P,TP,2	3	SA
...4		2011-001449	R-NETWORK;22ohm,5%,1/16W,L,4P,TP,1010	4	SA
...4	PC43	2203-000233	C-CER,CHIP;0.1nF,5%,50V,C0G,TP,1005	6	SA
...4	DC1	2203-000386	C-CER,CHIP;0.015nF,5%,50V,C0G,TP,1005	2	SA
...4	C254	2203-000438	C-CER,CHIP;1nF,10%,50V,X7R,TP,1005	12	SA
...4	C507	2203-000489	C-CER,CHIP;2.2nF,10%,50V,X7R,TP,1005	6	SA
...4	V1233	2203-000575	C-CER,CHIP;220nF,10%,25V,X7R,TP,2012	2	SNA
...4	AD480	2203-000679	C-CER,CHIP;0.027nF,5%,50V,C0G,TP,1005	2	SA
...4	AD480	2203-000714	C-CER,CHIP;3.3nF,10%,50V,X7R,TP,1005	4	SA
...4	AD480	2203-000995	C-CER,CHIP;0.047nF,5%,50V,C0G,TP,1005	2	SA
...4	AD480	2203-001412	C-CER,CHIP;0.03nF,5%,50V,NP0,TP,1005	4	SNA
...4	AD480	2203-002285	C-CER,CHIP;10nF,10%,50V,X7R,TP,1005	12	SNA
...4	AD480	2203-002525	C-CER,CHIP;0.56nF,10%,50V,X7R,TP,1005	4	SNA
...4	AC2	2203-002711	C-CER,CHIP;100nF,10%,25V,X7R,TP,1608	2	SA
...4	AD480	2203-005054	C-CER,CHIP;0.0047nF,0.25pF,50V,NP0,TP,10	2	SA
...4	AD480	2203-005083	C-CER,CHIP;220nF,10%,50V,X7R,TP,1608,0.8	1	SA
...4	AAC1	2203-005249	C-CER,CHIP;100nF,10%,50V,X7R,TP,1608	9	SNA
...4	AD480	2203-005344	C-CER,CHIP;22nF,10%,25V,X7R,TP,1005,0.5T	2	SNA
...4	VC37	2203-006048	C-CER,CHIP;100nF,10%,10V,X7R,TP,1005	88	SA
...4	AD480	2203-006126	C-CER,CHIP;47nF,10%,16V,X7R,TP,1005	15	SNA
...4	JC10	2203-006324	C-CER,CHIP;2200nF,10%,10V,X5R,TP,1608	7	SA
...4	C125	2203-006361	C-CER,CHIP;10000nF,10%,10V,X5R,TP,2012	11	SC
...4	HE4	2203-006474	C-CER,CHIP;22000nF,20%,6.3V,X5R,TP,2012	14	SA
...4	HDC11	2203-006562	C-CER,CHIP;1000nF,10%,10V,X5R,TP,1005	14	SNA
...4	C23	2203-006890	C-CER,CHIP;10000nF,20%,6.3V,X5R,TP,1608	29	SNA
...4	AD480	2203-006992	C-CER,CHIP;0.33nF,5%,50V,C0G,TP,1005	2	SNA
...4	AD480	2203-007176	C-CER,CHIP;10000nF,10%,16V,X5R,TP,2012,1	6	SNA
...4	T0052	2703-002238	INDUCTOR-SMD;1uH,5%,2012,2.38Ohm,23,Wire	2	SNA
...4	T0052	2703-003149	INDUCTOR-SMD;2.2uH,20%,5050,0.055Ohm,300	2	SA
...4		2703-003343	INDUCTOR-SMD;2.2uH,20%,2520,0.104Ohm,130	2	SNA
...4		2703-003930	INDUCTOR-SMD;4.7uH,20%,5050,0.072Ohm,245	4	SA
...4	X202	2801-003326	CRYSTAL-SMD;24MHz,30ppm,28-ABX,20pF,50oh	1	SA
...4	X202	2801-003948	CRYSTAL-SMD;12MHz,30ppm,28-AAN,12pF,60oh	1	SA

Exploded Views and Parts List

Level	Loc.	Part Code	Description & Specification	Qty.	SA/SNA
...4	T0568	3301-002039	BEAD-SMD;26ohm,1608,TP	41	SA
...4		3701-001784	CONNECTOR-HDMI;19P,2ROW,FEMALE,SMD-S,AU	2	SA
...4		3707-001106	CONNECTOR-OPTICAL;STRAIGHT W/L,SPDIF	1	SA
...4		3709-001712	CONNECTOR-CARD SLOT;68P,1.27mm,ANGLE,AU,	1	SA
...4	HB01A	3711-005925	HEADER-BOARD TO CABLE;BOX,51P,1R,0.5mm,S	1	SA
...4	EH01	3711-007582	HEADER-BOARD TO CABLE;BOX,8P,1R,2.0mm,AN	1	SA
...4		3711-007585	CONNECTOR-HEADER;BOX,4P,1R,2.5mm,ANGLE-D	1	SA
...4		3711-007741	CONNECTOR-HEADER;BOX,14P,2R,2.0mm,ANGLE,	1	SA
...4		3722-003213	JACK-PIN;J/B 5P + Screw hole,NI+SN,BLK,S	1	SA
...4		3722-003225	JACK-USB;4P/1C,Au,BLK,SMD-A(DIP),A	1	SA
...4		3722-003226	JACK-PHONE;7P/1C,SN,BLK	2	SA
...4		3722-003408	JACK-SCART;21P,SN,BLK	1	SA
...4	ET01	BN40-00231A	TUNER;DTOD40FVL084A,DTOD40FVL084A,DVB-TC	1	SA
...4		BN41-01795A	PCB MAIN;x9_dvb_isdb_integration,FR-4,4,	1	SNA
...4		BN97-06464A	ASSY MICOM;X9_SUB,U71A,U71B,2011.10.11,0	1	SNA
....5		0903-001718	IC-MICROCONTROLLER;61P805-RG480WT,LQFP,4	1	SNA
...4		BN97-06465A	ASSY MICOM;Onboot_MFM_X9_1000,2012.01.03	1	SNA
....5		1107-002076	IC-NOR FLASH;W25Q40BVSSIP,4Mbit,SOP,8P,5	1	SNA
...4		BN97-06488A	ASSY MICOM-E-MANUAL;U71A,U71B,2011.10.17	1	SNA
....5		1107-002049	IC-NAND FLASH;K9F1G08U0D-SCB0,1Gbit,128M	1	SNA
....5		BN46-00200A	S/W MICOM;T-MST9DEUC-XXXX,EU/AU/SH/MV/AB	1	SNA
....5		BN46-00202C	S/W-E-MANUAL;X9,DVBEU2,XH	1	SNA
...3		BN97-06736A	ASSY DRM-KEY;X9	1	SNA
...4		BN46-00110G	KEY CODE-CERTIFI;HDCP,TV,MSTAR,General	1	SNA
...4		BN46-00115H	KEY CODE-CERTIFI;CI+,TV,2012X,Euro	1	SNA
...3	T0066	BP62-00017A	HEAT SINK-ES;SP-50L2HX,A6063S,T2.0,26.2,	1	SNA
1		BN92-08038G	ASSY LABEL;UE5L,E5000	1	SNA
.2	T0527	BP68-00052B	LABEL-00,RATING;FPTV,PET,T0.05,93,73	1	SNA
1		BN92-10016A	ASSY P/MATERIAL;UEH5000,40	1	SNA
.2		6902-000379	BAG AIR;LDPE,T0.2,W1000,L1800,TRP,1260.0	1	SNA
.2	M040	6922-000003	BAND PP;PP,T0.8,W18,L1650M,TRP,DA69-9014	1	SNA
.2		BN68-02422B	LABEL-WARNING SHIPPING;ALL MODEL,A/P 100	1	SNA
.2		BN69-00257X	PACKING-SHEET PALLET;PACKING SHEET PALLE	1	SNA
.2		BN69-03982M	PAD PACKING-EDGE;EDGE,PAPER,-,T5,W120,L2	1	SNA
.2		BN69-05418A	PACKING-BAG WRAPPING;- ,LDPE,-,0,019,500,	2	SNA
.2		BN69-06640A	PACKING-PAD;PAD,PAPER,-,-,CB-SW4,1120,95	1	SNA
.2		BN69-06680A	PACKING-BAG SHEET ROLL;- ,CB,-,FOAM 0,5mm	2	SNA
.2		BN69-07019A	CUSHION-SET;UE5000 40",EPS,square stand	1	SNA
.2		BN69-07609A	PALLET;UE40EH5000,WOOD,-,1140,1100,135,-	1	SNA
.2		BN74-00008D	TAPE-OPP MASKING;OPP,T0.05,W75,L800M,CLR	2	SNA

Level	Loc.	Part Code	Description & Specification	Qty.	SA/SNA
1		BN92-11527C	ASSY BOX;UE5000 40	1	SNA
.2		BH68-00662A	LABEL BOX-00;ALL MODEL,MOJO 90G,60,110,W	1	SNA
.2		BN69-07258X	BOX-SET;40UE5020,CB,A-01,SW2,YEL,W1092,D	1	SNA
1	ACCE1	BN92-11629B	ASSY ACCESSORY;UE40EH5020WXXH	1	SNA
.2		BN68-04028G	LABEL-STICKER;UE5L,EDC,PET,T0.05,60,120,	1	SNA
.2	ACCE2	BN96-18701B	ASSY ACCESSORY-CABLE;UE5L,EUROPE	1	SNA
..3	T0268	3903-000603	CBF-POWER CORD;DT,CEE,LP-21L,250V,2.5A,B	1	SA
..3	T0120	4301-000121	BATTERY-MN;1.5V,R03,10.5x44.5m,HOLDER,7.	2	SNA
..3		6902-001340	BAG PE;LDPE,T0.05,W250,L350,TRP,RECYCLE	1	SNA
..3	REMO2	AA59-00602A	REMOCON;TM1240,44,3V,Europe,E6000	1	SA
..3		BN61-05491A	HOLDER-WIRE STAND;UB7000 46inch,NYRON	1	SNA
.2	ACCE4	BN96-24943Y	ASSY ACCESSORY-MANUAL;UE32EH5020WXXH,40	1	SNA
..3		6902-000476	BAG PE;LDPE,T0.03,W250,L350,TRP,Recycle,	1	SNA
..3	T0527	BN68-00513A	LABEL-E,PASS;ALL MODEL,YUPO(110G),50X15,	1	SNA
..3		BN68-03019A	LEAFLET-02,SAFETY GUIDE;ALL,SAMSUNG,28LE	1	SNA
..3		BN68-03548J	LEAFLET-02,WARRANTY CARD;comm,Samsung,17	1	SNA
..3		BN68-04524A	LEAFLET-5400_50"65";ALL,SAMSUNG,ENG,EURO	1	SNA
..3		BN68-04696A	MANUAL USERS;UEH5020,SAMSUNG,ENG/POL/SLV	1	SNA

1. Exploded View & Part List

Exploded View

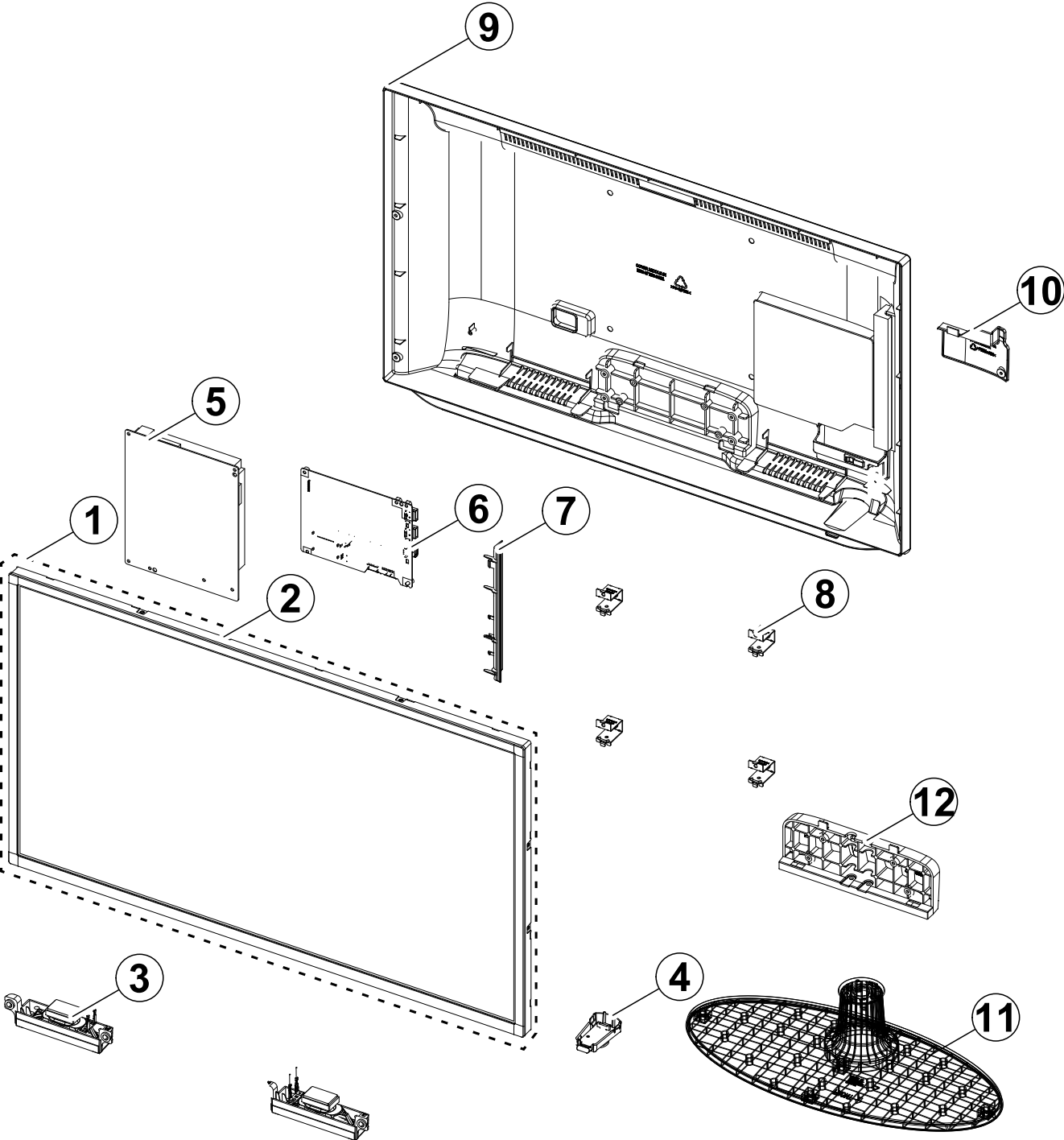

Parts List

No.	Lvl.	Loc.	Material Code	Description & Specification	SNA	Qty.
1	2	PANEL	BN95-00587A	PRODUCT LCD-AMLCD; 5k 40" Direct-LED,LTJ4	SA	1
2	3	TC01A	BN96-21617B	ASSY MISC P-CHASSIS TOP; Y12 Full LED, 40	SA	1
3	2	SP01A	BN96-21669B	ASSY SPEAKER P; 6ohm,4pin,10W,Enclosure t	SA	1
4	2	FB01A	BN96-22413B	ASSY BOARD P-JOG SWITCH & IR; UN40E5000,F	SA	1
5	2	P001A	BN44-00496A	DC VSS-LED TV PD BD; PD40AVF_CSM,PSLF760C	SA	1
6	2	M0014	BN94-06144V	ASSY PCB MAIN; UE40EH5020WXXH	SA	1
7	3		BN61-07946A	HOLDER-SIDE, AV; UE4000,26/32/40,EO,HIPS,	SNA	1
8	2	CB20	BN61-07952A	BRACKET-WALL; UE5000 40",EGI-SECC PL,T1.2	SNA	4
9	2		BN96-24871A	ASSY COVER P-MIDDLE REAR; UE40EH5000,,PC+	SA	1
10	3	FC05	BN63-09202G	COVER-JACK; 5000,40,ABS+PC,-,-,-,-,-,-,-,	SNA	1
11	2	SB04A	BN96-21736G	ASSY STAND P-BASE; UE5300,40/46,EO,PC/ABS	SA	1
12	2	SG01A	BN96-21742C	ASSY GUIDE P-STAND; UE5000,40/46/55,W/W,P	SA	1

2. Electrical Parts List

Level	Loc.	Part Code	Description & Specification	Qty.	SA/SNA
			UE40EH5020WXXH (TS01)		
1		BN90-03824B	ASSY COVER MIDDLE-REAR;UEH5000,40,EO	1	SNA
.2		6001-002755	SCREW-MACHINE;BH,+,M3,L6,ZPC(BLK),SWRCH1	4	SA
.2	SCREW	6003-001782	SCREW-TAPTYPE;BH,+,B,M4,L12,ZPC(BLK),SWR	9	SA
.2		BN96-24871A	ASSY COVER P-MIDDLE REAR;UE40EH5000,,PC+	1	SA
..3		BN63-07556T	COVER-SHEET;TOC,urethane,T0.068,W22mm,10	2	SNA
..3		BN63-09080B	COVER-MIDDLE REAR;UE5000 40,EO,PC+ABS G/	1	SNA
...4		0103-009559	RESIN-PC;210GNH15,6919A,BK0007,PC ABS GF	2200	SNA
..3	FC05	BN63-09202G	COVER-JACK;5000,40,ABS+PC,-,-,-,-,-,-,-,-,-,-	1	SNA
..3	T0071	BN64-01951A	INLAY-TERMINAL;UE4000-26/32/40,PS SHEET,	1	SNA
1	S001A	BN90-03831V	ASSY STAND;UEH5300,40/46,EO	1	SNA
.2	SB04A	BN96-21736G	ASSY STAND P-BASE;UE5300,40/46,EO,PC/ABS	1	SA
..3	SCREW	6003-001782	SCREW-TAPTYPE;BH,+,B,M4,L12,ZPC(BLK),SWR	3	SA
..3	SCREW	6003-001785	SCREW-TAPTYPE;FH,+,B,M4,L8,ZPC(BLK),SWRC	6	SA
..3		BN61-04692A	BOSS-PRIMER;#94,clear,35cps	0	SNA
..3	SG01	BN61-08036A	GUIDE-STAND NECK;UE5000,40,PC+G/F 20%,V2	1	SNA
..3		BN61-08105A	BRACKET-STAND BOTTOM;UE5000 40/46",EGI-S	1	SNA
..3	CCM1	BN63-02183D	COVER-SHEET;RhcM,PE Vinyl,T0.05,680mm,20	1	SNA
..3		BN63-09084B	COVER-STAND, BASE;UE5000,40/46,EO,ABS+PC	1	SNA
...4		0103-005041	RESIN-PC;FR3200TV,901408,BK0008,1.2mm V-	560	SNA
..3		BN67-00327D	RUBBER-FOOT;STAND,SILICON,13*13,T2,GRAY(7	SNA
.2	SG01A	BN96-21742C	ASSY GUIDE P-STAND;UE5000,40/46/55,W/W,P	1	SA
..3	T0524	6902-001063	BAG PE;LDPE,T0.05,W180,L350,TRP,RECYCLE	1	SNA
..3	SG03	BN61-07941A	GUIDE-STAND;UE5000/6000,40/46/55,W/W,PC+	1	SNA
...4		0103-007285	RESIN-PC;MW32020GFU,K032202GFV,BK0007,V2	260	SNA
...4		BN68-00513D	LABEL-RESIN;resin,-,art paper,-,10,25,-,	1	SNA
..3		BN68-04027C	MANUAL FLYER-03,STAND GUIDE;U4000(32),SA	1	SNA
..3		BN96-18013E	ASSY ACCESSORY-SCREW;6003-001782,4EA,ALL	2	SNA
...4	SCREW	6003-001782	SCREW-TAPTYPE;BH,+,B,M4,L12,ZPC(BLK),SWR	8	SA
...4		BN69-05418B	PACKING-BAG SCREW;BN96-18013E,CB,-,GREEN	2	SNA
1		BN91-07065F	ASSY SHIELD;UE5L,E5000	1	SNA
.2		6001-002756	SCREW-MACHINE;BH,+,M3,L6,ZPC(WHT),SWRCH1	13	SA
.2		BN02-00102B	TAPE FILAMENT;UE7000,#893,0.15,25,50,WHI	0	SNA
.2	EC13	BN39-01449Q	LEAD CONNECTOR;UN32D5000FXZA,Falt Connec	1	SA
.2	P001A	BN44-00496A	DC VSS-LED TV PD BD;PD40AVF_CSM,PSLF760C	1	SA
.2	CB20	BN61-07952A	BRACKET-WALL;UE5000 40",EGI-SECC PL,T1.2	4	SNA
.2	FL06	BN96-17116W	ASSY CABLE P-FFC;UN40EH5000,FFC,324mm,51	1	SA
.2	SP01A	BN96-21669B	ASSY SPEAKER P;6ohm,4pin,10W,Enclosure t	1	SA

Exploded Views and Parts List

Level	Loc.	Part Code	Description & Specification	Qty.	SA/SNA
.2	FB01A	BN96-22413B	ASSY BOARD P-JOG SWITCH & IR;UN40E5000,F	1	SA
1		BN91-08712A	ASSY LCM-AMLCD;BN95-00587A,LTJ400HM08-V	1	SNA
.2	PANEL	BN95-00587A	PRODUCT LCD-AMLCD;5k 40" Direct-LED,LTJ4	1	SA
...3	FL06	3809-002684	FFC CABLE-FLAT;60V,105C,47mm,66P,0.5mm,U	2	SNA
...3		6001-002757	SCREW-MACHINE;BH,+,M3,L4,ZPC(WHT),SWRCH1	3	SA
...3		BN02-00043C	TAPE ETC-SHEET FIXING;F-LED 32/40/46,3M	2	SNA
...3		BN63-09395B	COVER-T CON;Y12 F-LED (60Hz/120Hz),CC105	1	SNA
...3		BN68-02471A	LABEL-STICKER;WW,Art Paper,80,40,AV	1	SNA
...3		BN90-03650A	ASSY MISC-BLU;F-LED	1	SNA
...4		BN61-07891A	SUPPORT-PLATE;Y12 FULL LED,PC,CLEAR	2	SNA
...4		BN61-08058A	LGP-DIFFUSER PLATE;40" Diffuser Plate,P	1	SNA
...4		BN63-09221A	SHEET-REFLECTOR;40",F-LED, SY70 188,SHE	1	SNA
...4		BN63-09484A	SHEET-DIFFUSER;40inch DLED UTE24B-10E(6)	1	SNA
...4		BN63-09485A	SHEET-DIFFUSER;40inch DLED UTE24B-10B(0)	1	SNA
...4		BN96-21613B	ASSY MISC P-CHASSIS BOTTOM;Y12 F-LED 40"	1	SNA
....5		BN02-00094A	TAPE PET;Y12 F-LED,MT-PFR,T 0.05,W30,L40	1	SNA
....5		BN02-00102B	TAPE FILAMENT;UE7000,#893,0.15,25,50,WHI	1	SNA
....5	EC13	BN39-01588A	LEAD CONNECTOR;40" Direct wire-harness,F	1	SNA
....5		BN61-08161A	HOLDER-LED-PCB;Direct-LED,PC,white	2	SNA
....5		BN63-09500A	GASKET-EMI;Y12 Direct LED,Conductive Fab	4	SNA
....5	CC02	BN64-01896C	CHASSIS-BOTTOM;Y12 F-LED 40" _H-SLIDE,EGI	1	SNA
....5		BN96-21486A	ASSY MISC P-SUB PCB;40" Sub PCB,2pin*5ea	1	SNA
...4		BN96-21622A	ASSY FRAME P-MOLD MIDDLE U;Y12 Full LED	1	SNA
....5		BN60-00453A	SPACER-PANEL (UD);F-LED 40,MGT-30DG,L892	2	SNA
....5		BN60-00454A	SPACER-PANEL (LR);F-LED 40,MGT-30DG,L505	2	SNA
....5		BN61-07887A	FRAME-MOLD MIDDLE;Y12 F-LED 40",PC+G/F10	1	SNA
...4		BN96-24089A	ASSY MISC P-LED BAR;40inch Direct Slide	5	SNA
...4		BN96-24090A	ASSY MISC P-LED BAR;40inch Direct Slide	5	SNA
...3	TCON	BN95-00570B	ASSY T CON;FHD,60Hz 40	1	SA
...4		BN97-06362B	ASSY SMD;BN95-00570B	1	SNA
....5		0202-001477	SOLDER-CREAM;LST309-M,D20~45um,96.5Sn/3A	1	SNA
....5	D0254	0404-001314	DIODE-SCHOTTKY;B260A,60V,2000mA,SMA,TP	1	SNA
....5	D0254	0404-001373	DIODE-SCHOTTKY;PD3S160,60V,1000mA,PowerD	2	SNA
....5	T0139	0406-001200	DIODE-TVS;RCLAMP0504F,6/-/-V,150W,SC-70	1	SA
....5		0406-001317	DIODE-TVS;SMAJ14A,15.6/-/17.2V,400W,SMA	1	SNA
....5		0406-001445	DIODE-TVS;RClamp7512N,2.7/2.8/2.9,300W,S	2	SA
....5	Q613	0501-000465	TR-SMALL SIGNAL;MMBT3904,NPN,350mW,SOT-2	1	SA
....5		0502-001331	TR-POWER;NSS30100LT1G,PNP,310mW,SOT-23,T	2	SA
....5		0502-001345	TR-POWER;FCX491A,NPN,1000mW,SOT89,TR,900	3	SA
....5		0502-001346	TR-POWER;FCX591A,PNP,1000mW,SOT89,TR,30/	2	SA

Level	Loc.	Part Code	Description & Specification	Qty.	SA/SNA
....5		0505-002485	FET-SILICON;FDC658AP,P,-30V,-4A,0.075ohm	1	SA
....5		0505-002826	FET-SILICON;ZXMN6A07E,N,60V,1A,0.4ohm,0.	1	SNA
....5		1203-006905	IC-VOL. GENERATOR;iML7939AKD-TR,TQFN,48P	1	SNA
....5		1203-006999	IC-DC/DC CONVERTER;SM4152,QFN,48P,7x7mm,	1	SNA
....5		1404-001152	THERMISTOR-NTC;10KOHM,5%,3380K,1MW/C,TP	1	SA
....5	DR1	2007-000043	R-CHIP;1Kohm,1%,1/10W,TP,1608	4	SA
....5	PR4	2007-000052	R-CHIP;10Kohm,1%,1/10W,TP,1608	2	SA
....5	KAR13	2007-000060	R-CHIP;100Kohm,1%,1/10W,TP,1608	1	SNA
....5	R104	2007-000063	R-CHIP;150Kohm,1%,1/10W,TP,1608	1	SA
....5	ND51C2	2007-000066	R-CHIP;20Kohm,1%,1/10W,TP,1608	1	SNA
....5	KR24	2007-000067	R-CHIP;15Kohm,1%,1/10W,TP,1608	2	SNA
....5	KAR21	2007-000070	R-CHIP;0ohm,5%,1/10W,TP,1608	9	SA
....5	R510	2007-000108	R-CHIP;510Kohm,5%,1/10W,TP,1608	1	SA
....5	R105	2007-000138	R-CHIP;100ohm,5%,1/16W,TP,1005	4	SA
....5	R111	2007-000171	R-CHIP;0ohm,5%,1/16W,TP,1005	1	SNA
....5		2007-000231	R-CHIP;1.3Kohm,1%,1/10W,TP,1608	1	SA
....5	MR9	2007-000455	R-CHIP;18Kohm,1%,1/10W,TP,1608	1	SA
....5	PRS34	2007-000516	R-CHIP;2.7Kohm,1%,1/10W,TP,1608	3	SNA
....5	HDR7	2007-000570	R-CHIP;220ohm,1%,1/10W,TP,1608	3	SA
....5	JR11	2007-000614	R-CHIP;24Kohm,1%,1/10W,TP,1608	2	SNA
....5	PR2	2007-000651	R-CHIP;27Kohm,1%,1/10W,TP,1608	1	SA
....5	R945	2007-000726	R-CHIP;300ohm,1%,1/10W,TP,1608	1	SA
....5	HR60	2007-000779	R-CHIP;33ohm,1%,1/10W,TP,1608	7	SA
....5	V8932	2007-000857	R-CHIP;4.3Kohm,1%,1/10W,TP,1608	1	SNA
....5	HR10	2007-000962	R-CHIP;5.1Kohm,1%,1/10W,TP,1608	5	SA
....5	PR12	2007-000979	R-CHIP;5.6Kohm,1%,1/10W,TP,1608	1	SA
....5	CER42	2007-000999	R-CHIP;510ohm,1%,1/10W,TP,1608	1	SA
....5	AHR41	2007-001175	R-CHIP;8.2Kohm,1%,1/10W,TP,1608	1	SA
....5	R3301	2007-001433	R-CHIP;12Kohm,1%,1/10W,TP,1608	2	SA
....5		2007-002768	R-CHIP;6.2Kohm,1%,1/10W,TP,1608	1	SA
....5		2007-002900	R-CHIP;11Kohm,1%,1/10W,TP,1608	2	SNA
....5		2007-007136	R-CHIP;4.7Kohm,1%,1/16W,TP,1005	10	SNA
....5	DR4	2007-007142	R-CHIP;10Kohm,1%,1/16W,TP,1005	2	SNA
....5		2007-007306	R-CHIP;100ohm,1%,1/16W,TP,1005	12	SNA
....5		2007-007309	R-CHIP;12Kohm,1%,1/16W,TP,1005,0.35	2	SA
....5		2007-007310	R-CHIP;8.2Kohm,1%,1/16W,TP,1005	1	SA
....5		2007-007645	R-CHIP;51.1ohm,1%,1/10W,TP,1608	1	SA
....5	V8642	2007-007768	R-CHIP;13Kohm,1%,1/10W,TP,1608	1	SA
....5		2007-007798	R-CHIP;10ohm,1%,1/16W,TP,1005	16	SA
....5	S0F1352	2007-008596	R-CHIP;0.1ohm,1%,1/4W,TP,3216	1	SC

Exploded Views and Parts List

Level	Loc.	Part Code	Description & Specification	Qty.	SA/SNA
....5		2007-008779	R-CHIP;0ohm,1%,1/16W,TP,1005	4	SA
....5	AC139	2203-000491	C-CER,CHIP;2.2nF,10%,50V,X7R,TP,1608	2	SA
....5	KAC5	2203-001126	C-CER,CHIP;0.68nF,10%,50V,X7R,TP,1608	1	SNA
....5	C627	2203-001697	C-CER,CHIP;0.082nF,5%,50V,NP0,TP,1608	2	SA
....5	AVC08	2203-002398	C-CER,CHIP;22nF,10%,50V,X7R,TP,1608	1	SNA
....5	PPC2	2203-005148	C-CER,CHIP;100nF,10%,16V,X7R,TP,1608	1	SNA
....5	AAC1	2203-005249	C-CER,CHIP;100nF,10%,50V,X7R,TP,1608	5	SNA
....5	C236	2203-005918	C-CER,CHIP;1000nF,10%,6.3V,X7R,TP,1608	2	SNA
....5	C102	2203-006158	C-CER,CHIP;100nF,10%,16V,X7R,TP,1005,0.5	35	SNA
....5	AD480	2203-006320	C-CER,CHIP;2200nF,10%,16V,X7R,TP,2012	1	SNA
....5	AD480	2203-006698	C-CER,CHIP;1000nF,10%,25V,X7R,TP,1608,0.	11	SNA
....5	AD480	2203-006960	C-CER,CHIP;1000nF,10%,50V,X7R,TP,2012	2	SNA
....5	AD480	2203-007132	C-CER,CHIP;10000nF,10%,25V,X7R,TP,3216,1	3	SA
....5	AD480	2203-007193	C-CER,CHIP;10000nF,10%,6.3V,X7R,TP,2012	3	SA
....5	AD480	2203-007240	C-CER,CHIP;22000nF,20%,6.3V,X5R,TP,1608,	3	SA
....5	AD480	2203-007306	C-CER,CHIP;10000nF,10%,25V,X5R,TP,2012,1	3	SNA
....5	AD480	2203-007423	C-CER,CHIP;10000nF,10%,35V,X7R,TP,3216	7	SA
....5	AD480	2203-007424	C-CER,CHIP;4700nF,10%,50V,X7R,TP,3216	5	SA
....5		2409-001240	C-ORGANIC,SMD;33uF,20%,25V,LR,TP,7343(1.	1	SNA
....5		2703-003747	INDUCTOR-SMD;22uH,20%,6060,0.135ohm,1300	2	SA
....5		2703-003803	INDUCTOR-SMD;4.7uH,20%,6060,0.031ohm,270	1	SA
....5		2703-003862	INDUCTOR-SMD;10uH,20%,6060,0.065ohm,1900	2	SA
....5		2703-003867	INDUCTOR-SMD;22uH,20%,4040,0.29ohm,720mA	1	SA
....5	DR32	3301-000314	BEAD-SMD;120ohm,1608,TP,120ohm/100MHz	4	SNA
....5		3301-001864	BEAD-SMD;100ohm,1608,TP,55ohm/29MHz,145o	11	SA
....5		3601-001038	FUSE-SURFACE MOUNT;125V,3A,FAST-ACTING,C	1	SA
....5		3708-002656	CONNECTOR-FPC/FFC/PIC;68P,0.5mm,SMD-A,Au	2	SA
....5	HB01A	3711-005601	HEADER-BOARD TO CABLE;BOX,8P,1R,2mm,SMD-	1	SA
....5	HB01A	3711-005925	HEADER-BOARD TO CABLE;BOX,51P,1R,0.5mm,S	1	SA
....5		BN13-00044A	IC ASIC;LPFC041T0A-Q1,32,40,46 60Hz FHD	1	SA
....5		BN41-01797A	PCB MAIN;2012 60Hz Tcon,FR-4,2,1.2T,170	1	SNA
....5		BN97-06436B	ASSY MICOM;J400HM050K,24C128,2012.01.30,	1	SNA
.....6		1103-001321	IC-EEPROM;24WC128,128Kbit,16Kx8,SOP,8P,5	1	SA
....5		BN97-06450A	ASSY MICOM;LSJ400HM05,400HM05,2011.10.10	1	SNA
.....6		1103-001254	IC-EEPROM;24C02,2Kbit,256x8,TSSOP,8P,4.4	1	SA
...3		BN96-21517A	ASSY OPEN CELL;LSJ400HM05-E,8bit,40 INCH	1	SNA
...4		BN81-07433A	A/S-ADHESIVE-A.C.F(CF);ADHESIVE-A.C.F,1-	1	SNA
...4		BN81-07435A	A/S-ADHESIVE-A.C.F;ADHESIVE-A.C.F,2-ADHE	1	SNA
...4		BN81-07440A	A/S-ASSY PCB-SOURCE LEFT;ASSY PCB-SOURCE	1	SNA
...4		BN81-07453A	A/S-ASSY PCB-SOURCE RIGHT;ASSY PCB-SOURC	1	SNA

Level	Loc.	Part Code	Description & Specification	Qty.	SA/SNA
...4		BN81-07470A	A/S-IC DRIVER SOURCE;IC DRIVER SOURCE,2-	1	SNA
...4		BN81-07483A	A/S-POLARIZER-C/F;POLARIZER-C/F,2-POLARI	1	SNA
...4		BN81-07491A	A/S-POLARIZER-TFT;POLARIZER-TFT,2-POLARI	1	SNA
..3	TC01A	BN96-21617B	ASSY MISC P-CHASSIS TOP;Y12 Full LED, 40	1	SA
...4	T0069	AA63-60122K	SPACER-FELT;SPD-42P3S,FELT,L60,D20,T0.35	4	SNA
...4		BN60-00446A	SPACER-GASKET;Full-LED,FG200A,L25,t0.2,W	4	SNA
...4		BN60-00451A	SPACER-TOP (UD);Full-LED 40",FG200A,L90	2	SNA
...4		BN60-00452A	SPACER-TOP (LR);Full-LED 40",FG200A,L52	2	SNA
...4		BN60-00473B	SPACER-BLOCK;F-LED 40",MTU-R,889,BLK,T	1	SNA
...4		BN63-07229T	COVER-SHEET;Y12 F-LED,SILICONE,T0.052,W	4	SNA
...4	AC157	BN64-01901B	CHASSIS-TOP;Y12 F-LED 40",PC+ABS+G/F15%,	1	SNA
1	M0017	BN91-10127V	ASSY CHASSIS;UE40EH5020WXXH	1	SNA
..2	M0014	BN94-06144V	ASSY PCB MAIN;UE40EH5020WXXH	1	SA
..3		0202-001608	SOLDER-WIRE FLUX;LFC7-107,D0.8,99.3Sn/0.	0	SNA
..3		BN61-07946A	HOLDER-SIDE, AV;UE4000,26/32/40,EO,HIPS,	1	SNA
...4		0103-009565	RESIN-MPPE;ST855,1D129A,BK0020	20	SNA
..3		BN67-00364A	RUBBER;UE32EH5000,RUBBER,10X10,9T,10X10	1	SNA
..3		BN97-05369W	ASSY SMD;UE5L,E5000	1	SNA
...4		0202-001899	SOLDER-CREAM;M705-GRN360-K2-VT,25-36um,S	7	SNA
...4	DS01A	0401-001056	DIODE-SWITCHING;MMBD4148SE,100V,200mA,SO	1	SA
...4		0403-001785	DIODE-ZENER;NZH5V1B,4.94/5.2V,500mW,SOD-	1	SA
...4		0403-001797	DIODE-ZENER;NZH3V0B,2.85/3.15V,500mW,SOD	1	SNA
...4	D0254	0404-001404	DIODE-SCHOTTKY;BAT721C,40V,200mA,SOT-23,	1	SA
...4	SD3	0407-000114	DIODE-SWITCHING;KDS184,80V,100mA,SOT-23,	1	SNA
...4	KQ1	0501-000279	TR-SMALL SIGNAL;KSA1182-Y,PNP,150mW,SOT-	1	SA
...4	Q101	0501-000445	TR-SMALL SIGNAL;KTC3875S-Y,NPN,150mW,SOT	8	SC
...4	CEQ2	0505-000110	FET-SILICON;2N7002,N,60V,115mA,7.5ohm,0.	2	SA
...4	Q409	0505-002560	FET-SILICON;AO6415,P,-20V,-3.3A,0.15ohm,	1	SA
...4	IC104	0801-002630	IC-CMOS LOGIC;74AHCT1G08,2-INPUT AND GAT	1	SA
...4	ND51C2	0801-002780	IC-CMOS LOGIC;74LVC1G17,SCHMITT-TRIGGER	1	SA
...4	IC104	0801-003330	IC-CMOS LOGIC;Octal buffer,DQFN,20P,4.5x	2	SA
...4	IC104	0802-001012	IC-CMOS LOGIC;74LCX245,TRANSCEIVER,DQFN,	1	SNA
...4	IC112	1103-001310	IC-EEPROM;2Kbit,256x8,SOIC,8Z30,5x4mm,2.	3	SNA
...4		1103-001531	IC-EEPROM;S-24C256CI-J8T1U4,256Kbit,32Kx	1	SA
...4		1105-002194	IC-DDR3 SDRAM;K4B1G1646G-BCH9,DDR3 SDRAM	2	SA
...4		1201-003183	IC-AUDIO AMP;DRV612,HTSSOP,14P,5x4.4mm,D	1	SA
...4		1201-003333	IC-POWER AMP;NTP-7412S,MLF,48P,7x7mm,DUA	1	SA
...4		1203-004364	IC-VOL. DETECTOR;RT9818C-42PV,SOT-23,3P,	1	SA
...4		1203-006017	IC-VOL. DETECTOR;RT9824GJ8,TSOT23,8P,2.9	1	SA
...4	T0087	1203-006109	IC-POSI.FIXED REG.;S-1206B33-M3T1G,SOT-2	1	SA

Exploded Views and Parts List

Level	Loc.	Part Code	Description & Specification	Qty.	SA/SNA
...4	T0087	1203-006130	IC-POSIFIXED REG.;S-1172B25-U5T1G,SOT-8	1	SA
...4	T0087	1203-006135	IC-POSIFIXED REG.;AP1117D-33-GZ-13-89,T	1	SA
...4	T0087	1203-006136	IC-POSIFIXED REG.;AP1117D-18-GZ-13-89,T	1	SA
...4	IC012	1203-006138	IC-POSIAJUST REG.;AP1117DGZ-13-89,TO-2	1	SA
...4		1203-006710	IC-DC/DC CONVERTER;RT8016L-GQW,WQFN,8P,1	2	SA
...4		1203-007080	IC-DC/DC CONVERTER;AOZ1051PI,SO-8,8P,4.9	2	SA
...4		1204-003313	IC-DECODER;SEMS23,LFBGA,568P,20.2x20.2mm	1	SA
...4		1405-001271	VARISTOR;35V,20Vdc,5A,1.0x0.5x0.6mm,TP,1	9	SA
...4	MR604	2007-000137	R-CHIP;2Kohm,5%,1/16W,TP,1005	8	SNA
...4	R105	2007-000138	R-CHIP;100ohm,5%,1/16W,TP,1005	21	SA
...4	AVR73	2007-000142	R-CHIP;2.7Kohm,5%,1/16W,TP,1005	1	SNA
...4	R319	2007-000143	R-CHIP;4.7Kohm,5%,1/16W,TP,1005	38	SNA
...4	R104	2007-000148	R-CHIP;10Kohm,5%,1/16W,TP,1005	36	SA
...4	MR36	2007-000153	R-CHIP;22Kohm,5%,1/16W,TP,1005	7	SNA
...4	MR13	2007-000157	R-CHIP;47Kohm,5%,1/16W,TP,1005	7	SNA
...4	R123	2007-000159	R-CHIP;56Kohm,5%,1/16W,TP,1005	1	SNA
...4	DR39	2007-000162	R-CHIP;100Kohm,5%,1/16W,TP,1005	4	SNA
...4	MR16	2007-000168	R-CHIP;470Kohm,5%,1/16W,TP,1005	1	SNA
...4	HDR17	2007-000172	R-CHIP;10ohm,5%,1/16W,TP,1005	2	SNA
...4	R338	2007-000173	R-CHIP;22ohm,5%,1/16W,TP,1005	1	SNA
...4	UR23	2007-000174	R-CHIP;47ohm,5%,1/16W,TP,1005	2	SNA
...4	VR8	2007-000256	R-CHIP;1.6Kohm,1%,1/10W,TP,1608	1	SA
...4	R809	2007-000475	R-CHIP;1Mohm,1%,1/10W,TP,1608	3	SA
...4	S0F0522	2007-000691	R-CHIP;3.3Mohm,5%,1/10W,TP,1608	1	SA
...4	R726	2007-000695	R-CHIP;3.3ohm,5%,1/10W,TP,1608	4	SNA
...4	R124	2007-000775	R-CHIP;33Kohm,5%,1/16W,TP,1005	2	SNA
...4	R2007	2007-000803	R-CHIP;36Kohm,1%,1/10W,TP,1608	1	SA
...4	HR10	2007-000962	R-CHIP;5.1Kohm,1%,1/10W,TP,1608	1	SA
...4		2007-001285	R-CHIP;5.6ohm,5%,1/16W,TP,1005	2	SA
...4	OTR1	2007-001292	R-CHIP;33ohm,5%,1/16W,TP,1005	24	SNA
...4	DR43	2007-001298	R-CHIP;51ohm,5%,1/16W,TP,1005	2	SNA
...4	DR1	2007-001301	R-CHIP;68ohm,5%,1/16W,TP,1005	7	SA
...4	R16	2007-001313	R-CHIP;330ohm,5%,1/16W,TP,1005	2	SNA
...4	R326	2007-001325	R-CHIP;3.3Kohm,5%,1/16W,TP,1005	1	SNA
...4		2007-001333	R-CHIP;18Kohm,5%,1/16W,TP,1005	4	SNA
...4	PR24	2007-002970	R-CHIP;56ohm,5%,1/16W,TP,1005	4	SA
...4	HDR8	2007-007095	R-CHIP;390ohm,5%,1/16W,TP,1005	1	SA
...4		2007-007138	R-CHIP;27Kohm,1%,1/16W,TP,1005	1	SNA
...4	DR4	2007-007142	R-CHIP;10Kohm,1%,1/16W,TP,1005	4	SNA
...4		2007-007156	R-CHIP;1ohm,5%,1/16W,TP,1005	10	SNA

Level	Loc.	Part Code	Description & Specification	Qty.	SA/SNA
...4		2007-007313	R-CHIP;6.8Kohm,1%,1/16W,TP,1005	2	SA
...4		2007-007318	R-CHIP;1Kohm,1%,1/16W,TP,1005	24	SNA
...4		2007-007352	R-CHIP;130Kohm,1%,1/10W,TP,1608	2	SA
...4		2007-007463	R-CHIP;1.1Kohm,1%,1/16W,TP,1005	1	SA
...4		2007-007517	R-CHIP;240ohm,1%,1/16W,TP,1005	2	SNA
...4	MR11	2007-008015	R-CHIP;75ohm,1%,1/16W,TP,1005	9	SNA
...4		2007-008275	R-CHIP;30Kohm,1%,1/16W,TP,1005	2	SNA
...4		2007-008649	R-CHIP;220ohm,1%,1/16W,TP,1005	1	SNA
...4		2007-008779	R-CHIP;0ohm,1%,1/16W,TP,1005	6	SA
...4	DRP29	2011-000515	R-NETWORK;4.7Kohm,5%,1/16W,L,CHIP,8P,TP,	1	SA
...4	ZRN10	2011-001261	R-NETWORK;33ohm,5%,1/16W,L,CHIP,8P,TP,2.	6	SA
...4	DAR09	2011-001262	R-NETWORK;22ohm,5%,1/16W,L,CHIP,8P,TP,2.	5	SA
...4		2011-001264	R-NETWORK;10ohm,5%,1/16W,L,CHIP,8P,TP,2.	4	SNA
...4	HRP2	2011-001344	R-NETWORK;100ohm,5%,1/16W,L,CHIP,8P,TP,2	3	SA
...4		2011-001449	R-NETWORK;22ohm,5%,1/16W,L,4P,TP,1010	4	SA
...4	PC43	2203-000233	C-CER,CHIP;0.1nF,5%,50V,C0G,TP,1005	6	SA
...4	DC1	2203-000386	C-CER,CHIP;0.015nF,5%,50V,C0G,TP,1005	2	SA
...4	C254	2203-000438	C-CER,CHIP;1nF,10%,50V,X7R,TP,1005	12	SA
...4	C507	2203-000489	C-CER,CHIP;2.2nF,10%,50V,X7R,TP,1005	6	SA
...4	V1233	2203-000575	C-CER,CHIP;220nF,10%,25V,X7R,TP,2012	2	SNA
...4	AD480	2203-000679	C-CER,CHIP;0.027nF,5%,50V,C0G,TP,1005	2	SA
...4	AD480	2203-000714	C-CER,CHIP;3.3nF,10%,50V,X7R,TP,1005	4	SA
...4	AD480	2203-000995	C-CER,CHIP;0.047nF,5%,50V,C0G,TP,1005	2	SA
...4	AD480	2203-001412	C-CER,CHIP;0.03nF,5%,50V,NP0,TP,1005	4	SNA
...4	AD480	2203-002285	C-CER,CHIP;10nF,10%,50V,X7R,TP,1005	12	SNA
...4	AD480	2203-002525	C-CER,CHIP;0.56nF,10%,50V,X7R,TP,1005	4	SNA
...4	AC2	2203-002711	C-CER,CHIP;100nF,10%,25V,X7R,TP,1608	2	SA
...4	AD480	2203-005054	C-CER,CHIP;0.0047nF,0.25pF,50V,NP0,TP,10	2	SA
...4	AD480	2203-005083	C-CER,CHIP;220nF,10%,50V,X7R,TP,1608,0.8	1	SA
...4	AAC1	2203-005249	C-CER,CHIP;100nF,10%,50V,X7R,TP,1608	9	SNA
...4	AD480	2203-005344	C-CER,CHIP;22nF,10%,25V,X7R,TP,1005,0.5T	2	SNA
...4	VC37	2203-006048	C-CER,CHIP;100nF,10%,10V,X7R,TP,1005	88	SA
...4	AD480	2203-006126	C-CER,CHIP;47nF,10%,16V,X7R,TP,1005	15	SNA
...4	JC10	2203-006324	C-CER,CHIP;2200nF,10%,10V,X5R,TP,1608	7	SA
...4	C125	2203-006361	C-CER,CHIP;10000nF,10%,10V,X5R,TP,2012	11	SC
...4	HE4	2203-006474	C-CER,CHIP;22000nF,20%,6.3V,X5R,TP,2012	14	SA
...4	HDC11	2203-006562	C-CER,CHIP;1000nF,10%,10V,X5R,TP,1005	14	SNA
...4	C23	2203-006890	C-CER,CHIP;10000nF,20%,6.3V,X5R,TP,1608	29	SNA
...4	AD480	2203-006992	C-CER,CHIP;0.33nF,5%,50V,C0G,TP,1005	2	SNA
...4	AD480	2203-007176	C-CER,CHIP;10000nF,10%,16V,X5R,TP,2012,1	6	SNA

Exploded Views and Parts List

Level	Loc.	Part Code	Description & Specification	Qty.	SA/SNA
...4	T0052	2703-002238	INDUCTOR-SMD;1uH,5%,2012,2.38Ohm,23,Wire	2	SNA
...4	T0052	2703-003149	INDUCTOR-SMD;2.2uH,20%,5050,0.055Ohm,300	2	SA
...4		2703-003343	INDUCTOR-SMD;2.2uH,20%,2520,0.104Ohm,130	2	SNA
...4		2703-003930	INDUCTOR-SMD;4.7uH,20%,5050,0.072Ohm,245	4	SA
...4	X202	2801-003326	CRYSTAL-SMD;24MHz,30ppm,28-ABX,20pF,50oh	1	SA
...4	X202	2801-003948	CRYSTAL-SMD;12MHz,30ppm,28-AAN,12pF,60oh	1	SA
...4	T0568	3301-002039	BEAD-SMD;26ohm,1608,TP	41	SA
...4		3701-001784	CONNECTOR-HDMI;19P,2ROW,FEMALE,SMD-S,AU	2	SA
...4		3707-001106	CONNECTOR-OPTICAL;STRAIGHT W/L,SPDIF	1	SA
...4		3709-001712	CONNECTOR-CARD SLOT;68P,1.27mm,ANGLE,AU,	1	SA
...4	HB01A	3711-005925	HEADER-BOARD TO CABLE;BOX,51P,1R,0.5mm,S	1	SA
...4	EH01	3711-007582	HEADER-BOARD TO CABLE;BOX,8P,1R,2.0mm,AN	1	SA
...4		3711-007585	CONNECTOR-HEADER;BOX,4P,1R,2.5mm,ANGLE-D	1	SA
...4		3711-007741	CONNECTOR-HEADER;BOX,14P,2R,2.0mm,ANGLE,	1	SA
...4		3722-003213	JACK-PIN;J/B 5P + Screw hole,NI+SN,BLK,S	1	SA
...4		3722-003225	JACK-USB;4P/1C,Au,BLK,SMD-A(DIP),A	1	SA
...4		3722-003226	JACK-PHONE;7P/1C,SN,BLK	2	SA
...4		3722-003408	JACK-SCART;21P,SN,BLK	1	SA
...4	ET01	BN40-00231A	TUNER;DTOD40FVL084A,DTOD40FVL084A,DVB-TC	1	SA
...4		BN41-01795A	PCB MAIN;x9_dvb_isdb_integration,FR-4,4,	1	SNA
...4		BN97-06464A	ASSY MICOM;X9_SUB,U71A,U71B,2011.10.11,0	1	SNA
....5		0903-001718	IC-MICROCONTROLLER;61P805-RG480WT,LQFP,4	1	SNA
...4		BN97-06465A	ASSY MICOM;Onboot_MFM_X9_1000,2012.01.03	1	SNA
....5		1107-002076	IC-NOR FLASH;W25Q40BVSSIP,4Mbit,SOP,8P,5	1	SNA
...4		BN97-06488A	ASSY MICOM-E-MANUAL;U71A,U71B,2011.10.17	1	SNA
....5		1107-002049	IC-NAND FLASH;K9F1G08U0D-SCB0,1Gbit,128M	1	SNA
....5		BN46-00200A	S/W MICOM;T-MST9DEUC-XXXX,EU/AU/SH/MV/AB	1	SNA
....5		BN46-00202C	S/W-E-MANUAL;X9,DVBEU2,XH	1	SNA
...3		BN97-06736A	ASSY DRM-KEY;X9	1	SNA
...4		BN46-00110G	KEY CODE-CERTIFI;HDCP,TV,MSTAR,General	1	SNA
...4		BN46-00115H	KEY CODE-CERTIFI;CI+,TV,2012X,Euro	1	SNA
...3	T0066	BP62-00017A	HEAT SINK-ES;SP-50L2HX,A6063S,T2.0,26.2,	1	SNA
1		BN92-08038G	ASSY LABEL;UE5L,E5000	1	SNA
.2	T0527	BP68-00052B	LABEL-00,RATING;FPTV,PET,T0.05,93,73	1	SNA
1		BN92-10016A	ASSY P/MATERIAL;UEH5000,40	1	SNA
.2		6902-000379	BAG AIR;LDPE,T0.2,W1000,L1800,TRP,1260.0	1	SNA
.2	M040	6922-000003	BAND PP;PP,T0.8,W18,L1650M,TRP,DA69-9014	1	SNA
.2		BN68-02422B	LABEL-WARNING SHIPPING;ALL MODEL,A/P 100	1	SNA
.2		BN69-00257X	PACKING-SHEET PALLET;PACKING SHEET PALLE	1	SNA
.2		BN69-03982M	PAD PACKING-EDGE;EDGE,PAPER,-,T5,W120,L2	1	SNA

Level	Loc.	Part Code	Description & Specification	Qty.	SA/SNA
.2		BN69-05418A	PACKING-BAG WRAPPING;-LDPE,-,0,019,500,	2	SNA
.2		BN69-06640A	PACKING-PAD;PAD,PAPER,-,-,CB-SW4,1120,95	1	SNA
.2		BN69-06680A	PACKING-BAG SHEET ROLL;-CB,-,FOAM 0,5mm	2	SNA
.2		BN69-07019A	CUSHION-SET;UE5000 40",EPS,square stand	1	SNA
.2		BN69-07609A	PALLET;UE40EH5000,WOOD,-,1140,1100,135,-	1	SNA
.2		BN74-00008D	TAPE-OPP MASKING;OPP,T0.05,W75,L800M,CLR	2	SNA
1		BN92-11527C	ASSY BOX;UE5000 40	1	SNA
.2		BH68-00662A	LABEL BOX-00;ALL MODEL,MOJO 90G,60,110,W	1	SNA
.2		BN69-07258X	BOX-SET;40UE5020,CB,A-01,SW2,YEL,W1092,D	1	SNA
1	ACCE1	BN92-11629B	ASSY ACCESSORY;UE40EH5020WXXH	1	SNA
.2		BN68-04028G	LABEL-STICKER;UE5L,EDC,PET,T0.05,60,120,	1	SNA
.2	ACCE2	BN96-18701B	ASSY ACCESSORY-CABLE;UE5L,EUROPE	1	SNA
..3	T0268	3903-000603	CBF-POWER CORD;DT,CEE,LP-21L,250V,2.5A,B	1	SA
..3	T0120	4301-000121	BATTERY-MN;1.5V,R03,10.5x44.5m,HOLDER,7.	2	SNA
..3		6902-001340	BAG PE;LDPE,T0.05,W250,L350,TRP,RECYCLE	1	SNA
..3	REMO2	AA59-00602A	REMOCON;TM1240,44,3V,Europe,E6000	1	SA
..3		BN61-05491A	HOLDER-WIRE STAND;UB7000 46inch,NYRON	1	SNA
.2	ACCE4	BN96-24943Y	ASSY ACCESSORY-MANUAL;UE32EH5020WXXH,40	1	SNA
..3		6902-000476	BAG PE;LDPE,T0.03,W250,L350,TRP,Recycle,	1	SNA
..3	T0527	BN68-00513A	LABEL-E,PASS;ALL MODEL,YUPO(110G),50X15,	1	SNA
..3		BN68-03019A	LEAFLET-02,SAFETY GUIDE;ALL,SAMSUNG,28LE	1	SNA
..3		BN68-03548J	LEAFLET-02,WARRANTY CARD;comm,Samsung,17	1	SNA
..3		BN68-04524A	LEAFLET-5400_50"65";ALL,SAMSUNG,ENG,EURO	1	SNA
..3		BN68-04696A	MANUAL USERS;UEH5020,SAMSUNG,ENG/POL/SLV	1	SNA