



LED TV

Chassis:	U78A	U78B
Model:	UE26EH45***	UE22ES54***
	UE**EH53***	
	UE**ES55***	
	UE**ES57***	
	UE**ES58***	
	UE**EH5450W	

SERVICE MANUAL

LED TV



UE**ES55***

1. Precautions

1.1. Safety Precautions

Follow these safety, servicing and ESD precautions to prevent damage and to protect against potential hazards such as electrical shock.

1-1-1. Warnings



For continued safety, do not attempt to modify the circuit board.
Disconnect the AC power and DC power jack before servicing.

1-1-2. Servicing the LED TV

1. When servicing the LED TV, Disconnect the AC line cord from the AC outlet.
2. It is essential that service technicians have an accurate voltage meter available at all times. Check the calibration of this meter periodically.

1-1-3. Fire and Shock Hazard

Before returning the monitor to the user, perform the following safety checks:

1. Inspect each lead dress to make certain that the leads are not pinched or that hardware is not lodged between the chassis and other metal parts in the monitor.
2. Inspect all protective devices such as nonmetallic control knobs, insulating materials, cabinet backs, adjustment and compartment covers or shields, isolation resistor/capacitor networks, mechanical insulators, etc.
3. Leakage Current Hot Check:

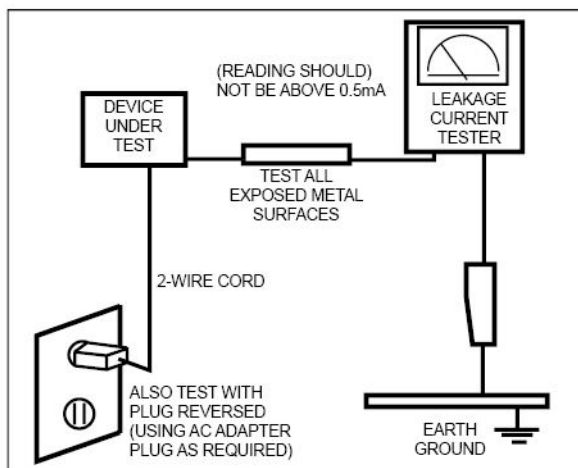

Do not use an isolation transformer during this test.

Use a leakage current tester or a metering system that complies with American National Standards Institute (ANSI C101.1, Leakage Current for Appliances), and Underwriters Laboratories (UL Publication UL1410, 59.7).

4. With the unit completely reassembled, plug the AC line cord directly into a 120V AC outlet. With the unit's AC switch first in the ON position and then OFF, measure the current between a known earth ground (metal water pipe, conduit, etc.) and all exposed metal parts, including: metal cabinets, screwheads and control shafts. The current measured should not exceed 0.5 milliamp. Reverse the power-plug prongs in the AC outlet and repeat the test.

1-1-4. Product Safety Notices

Some electrical and mechanical parts have special safety-related characteristics which are often not evident from visual inspection. The protection they give may not be obtained by replacing them with components rated for higher voltage, wattage, etc. Parts that have special safety characteristics are identified by  on schematics and parts lists. A substitute replacement that does not have the same safety characteristics as the recommended replacement part might create shock, fire and/or other hazards. Product safety is under review continuously and new instructions are issued whenever appropriate.

1.2. Servicing Precautions



An electrolytic capacitor installed with the wrong polarity might explode.



Before servicing units covered by this service manual, read and follow the Safety Precautions section of this manual.



If unforeseen circumstances create conflict between the following servicing precautions and any of the safety precautions, always follow the safety precautions.

1-2-1. General Servicing Precautions

1. Always unplug the unit's AC power cord from the AC power source and disconnect the DC Power Jack before attempting to: (a) remove or reinstall any component or assembly, (b) disconnect PCB plugs or connectors, (c) connect a test component in parallel with an electrolytic capacitor.
2. Some components are raised above the printed circuit board for safety. An insulation tube or tape is sometimes used. The internal wiring is sometimes clamped to prevent contact with thermally hot components. Reinstall all such elements to their original position.
3. After servicing, always check that the screws, components and wiring have been correctly reinstalled. Make sure that the area around the serviced part has not been damaged.
4. Check the insulation between the blades of the AC plug and accessible conductive parts (examples: metal panels, input terminals and earphone jacks).
5. Insulation Checking Procedure: Disconnect the power cord from the AC source and turn the power switch ON. Connect an insulation resistance meter (500 V) to the blades of the AC plug. The insulation resistance between each blade of the AC plug and accessible conductive parts (see above) should be greater than 1 megohm.
6. Always connect a test instrument's ground lead to the instrument chassis ground before connecting the positive lead; always remove the instrument's ground lead last.

1.3. Static Electricity Precautions

Some semiconductor (solid state) devices can be easily damaged by static electricity. Such components are commonly called Electrostatically Sensitive Devices (ESD). Examples of typical ESD are integrated circuits and some field-effect transistors. The following techniques will reduce the incidence of component damage caused by static electricity.

1. Immediately before handling any semiconductor components or assemblies, drain the electrostatic charge from your body by touching a known earth ground. Alternatively, wear a discharging wrist-strap device. To avoid a shock hazard, be sure to remove the wrist strap before applying power to the monitor.
2. After removing an ESD-equipped assembly, place it on a conductive surface such as aluminum foil to prevent accumulation of an electrostatic charge.
3. Do not use freon-propelled chemicals. These can generate electrical charges sufficient to damage ESDs.
4. Use only a grounded-tip soldering iron to solder or desolder ESDs.
5. Use only an anti-static solder removal device. Some solder removal devices not classified as “anti-static” can generate electrical charges sufficient to damage ESDs.
6. Do not remove a replacement ESD from its protective package until you are ready to install it. Most replacement ESDs are packaged with leads that are electrically shorted together by conductive foam, aluminum foil or other conductive materials.
7. Immediately before removing the protective material from the leads of a replacement ESD, touch the protective material to the chassis or circuit assembly into which the device will be installed.



Be sure no power is applied to the chassis or circuit and observe all other safety precautions.

CAUTION

8. Minimize body motions when handling unpackaged replacement ESDs. Motions such as brushing clothes together, or lifting your foot from a carpeted floor can generate enough static electricity to damage an ESD.



1.4. Installation Precautions

1. For safety reasons, more than a people are required for carrying the product.
2. Keep the power cord away from any heat emitting devices, as a melted covering may cause fire or electric shock.
3. Do not place the product in areas with poor ventilation such as a bookshelf or closet. The increased internal temperature may cause fire.
4. Bend the external antenna cable when connecting it to the product. This is a measure to protect it from being exposed to moisture. Otherwise, it may cause a fire or electric shock.
5. Make sure to turn the power off and unplug the power cord from the outlet before repositioning the product. Also check the antenna cable or the external connectors if they are fully unplugged. Damage to the cord may cause fire or electric shock.
6. Keep the antenna far away from any high-voltage cables and install it firmly. Contact with the highvoltage cable or the antenna falling over may cause fire or electric shock.
7. When installing the product, leave enough space (0.4m) between the product and the wall for ventilation purposes. A rise in temperature within the product may cause fire.

2. Product specifications



2.1. Product Information

2-1-1. Model Comparison

Model	UE**ES55** / UE**ES57** / UE**ES58**		
Front View	 <p style="text-align: center;">* W : Width H : High D : Depth</p>		
Detail View			
Front Color	Black (Panel)		
Dimensions (W x H x D)	32"	Set with Stand	740.2 x 489.5 x 180.7 mm / 29.1 x 19.3 x 7.1 inches
		Set without Stand	740.2 x 449.3 x 46.9 mm / 29.1 x 17.7 x 1.8 inches
		Set with Stand (58**)	740.2 x 516.1 x 241.3 mm / 29.1 x 20.3 x 9.5 inches
	37"	Set with Stand	862.0 x 569.1 x 184.1 mm / 33.9 x 22.4 x 7.2 inches
		Set without Stand	862.0 x 518.3 x 46.9 mm / 33.9 x 20.4 x 1.8 inches
	40"	Set with Stand	927.4 x 605.5 x 184.1 mm / 36.5 x 23.8 x 7.2 inches
		Set without Stand	927.4 x 554.7 x 46.9 mm / 36.5 x 21.8 x 1.8 inches
		Set with Stand (58**)	927.4 x 620.4 x 241.3 mm / 36.5 x 24.4 x 9.5 inches
	46"	Set with Stand	1062.8 x 682.4 x 228.1 mm / 41.8 x 26.9 x 9.0 inches
		Set without Stand	1062.8 x 631.1 x 46.9 mm / 41.8 x 24.8 x 1.8 inches
Set with Stand (58**)		1062.8 x 702.1 x 276.6 mm / 41.8 x 27.6 x 10.9 inches	
50"	Set with Stand	1139.6 x 725.2 x 228.1 mm / 44.9 x 28.6 x 9.0 inches	
	Set without Stand	1139.6 x 674.0 x 46.9 mm / 44.9 x 26.5 x 1.8 inches	



2. Product specifications

Model	UE**ES55*** / UE**ES57*** / UE**ES58***		
Weight	32"	Set with Stand	6.7 kg / 14.8 lbs
		Set without Stand	6.2 kg / 13.7 lbs
		Set with Stand (58**)	7.4 kg / 16.3 lbs
	37"	Set with Stand	10.9 kg / 24.0 lbs
		Set without Stand	8.8 kg / 19.4 lbs
	40"	Set with Stand	12.5 kg / 27.6 lbs
		Set without Stand	10.3 kg / 22.7 lbs
		Set with Stand (58**)	12.5 kg / 27.6 lbs
	46"	Set with Stand	15.3 kg / 33.7 lbs
		Set without Stand	13.2 kg / 29.1 lbs
		Set with Stand (58**)	15.0 kg / 33.1 lbs
	50"	Set with Stand	16.7 kg / 36.8 lbs
Set without Stand		14.6 kg / 32.2 lbs	
Panel Type	Anti Glare		
Internal Memory	2 G		
DDR	256 Mbyte x 3 (768 Mbyte)		
Feature	Samsung SMART TV, AllShare (Powerd By DLNA), Anynet+ (HDMI-CEC)		

Model	UE**EH53***		
Front View	 <p style="text-align: center;">* W : Width H : High D : Depth</p>		
Detail View			
Front Color	Black (Panel)		
Dimensions (W x H x D)	32"	Set with Stand	738.3 x 498.2 x 191.7 mm / 29.1 x 19.6 x 7.5 inches
		Set without Stand	738.3 x 444.9 x 93.2 mm / 29.1 x 17.5 x 3.7 inches
	37"	Set with Stand	866.5 x 575.5 x 227.6 mm / 34.1 x 22.7 x 9.0 inches
		Set without Stand	866.5 x 519.2 x 93.0 mm / 34.1 x 20.4 x 3.7 inches
	40"	Set with Stand	927.6 x 606.5 x 227.6 mm / 36.5 x 23.9 x 9.0 inches
		Set without Stand	927.6 x 551.0 x 93.0 mm / 36.5 x 20.1 x 3.7 inches
	46"	Set with Stand	1059.8 x 680.7 x 227.6 mm / 41.7 x 26.8 x 9.0 inches
		Set without Stand	1059.8 x 625.6 x 94.3 mm / 41.7 x 24.6 x 3.7 inches
50"	Set with Stand	1137.6 x 725.0 x 227.6 mm / 44.8 x 28.5 x 9.0 inches	
	Set without Stand	1137.6 x 669.4 x 94.5 mm / 44.8 x 26.4 x 3.7 inches	

2. Product specifications

Model	UE**EH53***		
Weight	32"	Set with Stand	6.6 kg / 14.6 lbs
		Set without Stand	5.9 kg / 13.0 lbs
	37"	Set with Stand	10.2 kg / 22.5 lbs
		Set without Stand	8.0 kg / 17.6 lbs
	40"	Set with Stand	11.0 kg / 24.3 lbs
		Set without Stand	9.0 kg / 19.8 lbs
	46"	Set with Stand	14.5 kg / 32.0 lbs
		Set without Stand	12.5 kg / 27.6 lbs
50"	Set with Stand	18.3 kg / 40.3 lbs	
	Set without Stand	15.7 kg / 34.6 lbs	
Panel Type	Anti Glare		
Internal Memory	2 G		
DDR	256 Mbyte x 3 (768 Mbyte)		
Feature	Samsung SMART TV, AllShare (Powerd By DLNA), Anynet+ (HDMI-CEC)		

Model	UE**EH5450W		
Front View	 <p>* W : Width H : High D : Depth</p>		
Detail View			
Front Color	Black (Panel)		
Dimensions (W x H x D)	32"	Set with Stand	738.3 x 498.2 x 191.7 mm / 29.1 x 19.6 x 7.5 inches
		Set without Stand	738.3 x 444.9 x 93.2 mm / 29.1 x 17.5 x 3.7 inches
	40"	Set with Stand	927.6 x 606.5 x 227.6 mm / 36.5 x 23.9 x 9.0 inches
		Set without Stand	927.6 x 551.0 x 93.0 mm / 36.5 x 20.1 x 3.7 inches
	46"	Set with Stand	1059.8 x 680.7 x 227.6 mm / 41.7 x 26.8 x 9.0 inches
		Set without Stand	1059.8 x 625.6 x 94.3 mm / 41.7 x 24.6 x 3.7 inches
Weight	32"	Set with Stand	6.6 kg / 14.6 lbs
		Set without Stand	5.9 kg / 13.0 lbs
	40"	Set with Stand	11.0 kg / 24.3 lbs
		Set without Stand	9.0 kg / 19.8 lbs
	46"	Set with Stand	14.5 kg / 32.0 lbs
		Set without Stand	12.5 kg / 27.6 lbs
Panel Type	Anti Glare		
Internal Memory	2 G		
DDR	256 Mbyte x 3 (768 Mbyte)		
Feature	Samsung SMART TV, AllShare (Powerd By DLNA), Anynet+ (HDMI-CEC)		

2. Product specifications

Model	UE26EH45***		
<p>Front View</p>	 <p style="text-align: center;">* W : Width H : High D : Depth</p>		
<p>Detail View</p>			
<p>Front Color</p>	<p>Black (Panel)</p>		
<p>Dimensions (W x H x D)</p>	<p>26"</p>	<p>Set with Stand</p>	<p>632.1 x 445.6 x 180.7 mm / 24.9 x 17.5 x 7.1 inches</p>
		<p>Set without Stand</p>	<p>632.1 x 392.7 x 97.4 mm / 24.9 x 15.5 x 3.8 inches</p>
		<p>Set with Stand (E4510)</p>	<p>632.1 x 448.6 x 176.3 mm / 24.9 x 17.7 x 6.9 inches</p>
<p>Weight</p>	<p>26"</p>	<p>Set with Stand</p>	<p>4.9 kg / 10.8 lbs</p>
		<p>Set without Stand</p>	<p>4.4 kg / 9.7 lbs</p>
		<p>Set with Stand (E4510)</p>	<p>5.1 kg / 11.2 lbs</p>
<p>Panel Type</p>	<p>Anti Glare</p>		
<p>Internal Memory</p>	<p>2 G</p>		
<p>DDR</p>	<p>256 Mbyte x 3 (768 Mbyte)</p>		
<p>Feature</p>	<p>Samsung SMART TV, AllShare (Powerd By DLNA), Anynet+ (HDMI-CEC)</p>		

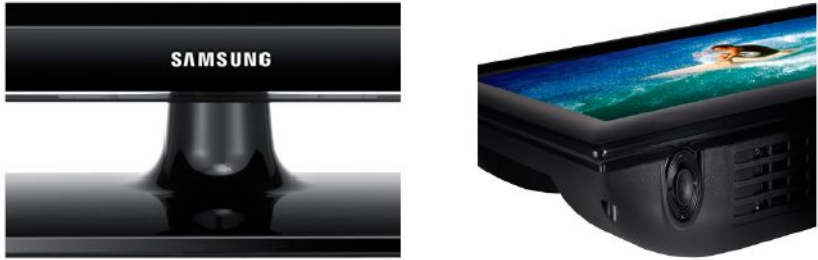
Model	UE22ES54***		
Front View	 <p style="text-align: center;">* W: Width H: High D: Depth</p>		
Detail View			
Front Color	Black (Panel)		
Dimensions (W x H x D)	22"	Set with Stand	522.9 x 377.5 x 169.7 mm / 20.6 x 14.9 x 6.7 inches
		Set without Stand	522.9 x 323.6 x 49.9 mm / 20.6 x 12.7 x 6.7 inches
		Set with Stand (5410)	522.9 x 376 x 144.8 mm / 20.6 x 14.8 x 2.0 inches
Weight	22"	Set with Stand	3.7 kg / 8.2 lbs
		Set without Stand	3.4 kg / 7.5 lbs
		Set with Stand (5410)	3.8 kg / 8.4 lbs
Panel Type	Anti Glare		
Internal Memory	2 G		
DDR	256 Mbyte x 3 (768 Mbyte)		
Feature	Samsung SMART TV, AllShare (Powerd By DLNA), Anynet+ (HDMI-CEC)		

2-1-2. Feature & Specifications

Model	UE32ES55***	
Feature		
<ul style="list-style-type: none"> • Digital-TV, RF, 3-HDMI, 1-SCART, 1-Component, 1-A/V, 2-USB2.0(AllShare Play), LAN • High Contrast Ratio : Mega Contrast • Dynamic contrast, Super-PVA • Response Time : 8 ms • CMR : 100 • PIP (in HDMI 1, 2, 3 Component and Sub picture is available only in TV mode(DTV/ATV)) • Dolby Digital Plus/ DolbyPulse, SRS TheaterSound HD 		
Specifications		
Item	Description	
LCD Panel	32 inch FHD 60Hz	
Scanning Frequency	Horizontal : 50 kHz ~ 73 kHz (Automatic) Vertical : 47 Hz ~ 63 Hz (Automatic)	
Display Colors	16.7M colors	
Maximum Resolution	Horizontal : 1920 Pixels Vertical : 1080 Pixels	
Input Signal	Analog 0.7 Vp-p ± 5% positive at 75Ω, internally terminated	
Input Sync Signal	H/V Separate, TTL, P. or N.	
Maximum Pixel Clock Rate	74.25 MHz	
Active Display (H x V)* * Horizontal x Vertical	698.4(H) X 392.9(V) (mm) / 27.5(H) X 15.47(V) (inches)	
AC Power Voltage & Frequency	AC 220 V ~ 240 V, 50 / 60 Hz	
Power Consumption	75 W (Under 0.3 W, Stand by) Europe area 78 W (Under 0.3 W, Stand by) CIS area	
System	TV	Analogue :B/G, D/K, L, I(Depending on your country selection) Digital: DVB-T/DVB-C *UK, Nordic, Russia, UKR Area : DVB-T2/DVB-C *Russia, UKR Area Model Code: UE32ES55*7KXRU(UA)
	Colour Video	Analogue: PAL, SECAM, NTSC-4.43, NTSC-3.58, PAL60 Digital: MPEG-2 MP@ML, MPEG-4, H.264/AVC MP@L3 MP@L4.0, HP@L4.0
	Sound	BG, DK, L, NICAM, MPEG1, DD, DD+, HEAAC

Specifications	
Item	Description
Environmental Considerations	Operating Temperature : 50°F ~ 104°F (10°C ~ 40°C) Operating Humidity : 10% ~ 80% Storage Temperature : -4°F ~ 113°F (-20°C ~ 45°C) Storage Humidity : 5% ~ 95%
Audio Specifications	MAX Internal Audio Output Power : Each 10 W(Left/Right) Equalizer : 5 Band Output Frequency : <ul style="list-style-type: none"> • RF : 20 Hz ~ 15.4 kHz • AV/Componet/HDMI : 20 Hz ~ 20 kHz
Note : Game Mode, smart hub, Energy Saving, Ultra slim	

2. Product specifications

Model	UE37ES55***	
Feature		
<ul style="list-style-type: none"> • Digital-TV, RF, 3-HDMI, 1-SCART, 1-Component, 1-A/V, 2-USB2.0(AllShare Play), LAN • High Contrast Ratio : Mega Contrast • Dynamic contrast, Super-PVA • Response Time : 8 ms • CMR : 100 • PIP(in HDMI 1, 2, 3 Component and Sub picture is available only in TV mode(DTV/ATV)) • Dolby Digital Plus/ DolbyPulse, SRS TheaterSound HD 		
Specifications		
Item	Description	
LCD Panel	37 inch FHD 60Hz	
Scanning Frequency	Horizontal : 50 kHz ~ 73 kHz (Automatic) Vertical : 47 Hz ~ 63 Hz (Automatic)	
Display Colors	16.7M colors	
Maximum Resolution	Horizontal : 1920 Pixels Vertical : 1080 Pixels	
Input Signal	Analog 0.7 Vp-p ± 5% positive at 75Ω, internally terminated	
Input Sync Signal	H/V Separate, TTL, P. or N.	
Maximum Pixel Clock Rate	74.25 MHz	
Active Display (H x V)* * Horizontal x Vertical	819.4(H) X 460.9(V) (mm) / 32.26(H) X 18.15(V) (inches)	
AC Power Voltage & Frequency	AC 220 V ~ 240 V, 50 / 60 Hz	
Power Consumption	94 W (Under 0.3 W, Stand by)	
System	TV	Analogue :B/G, D/K, L, I(Depending on your country selection) Digital: DVB-T/DVB-C *UK, Nordic Area : DVB-T2/DVB-C
	Colour Video	Analogue: PAL, SECAM, NTSC-4.43, NTSC-3.58, PAL60 Digital: MPEG-2 MP@ML, MPEG-4, H.264/AVC MP@L3 MP@L4.0, HP@L4.0
	Sound	BG, DK, L, NICAM, MPEG1, DD, DD+, HEAAC
Environmental Considerations	Operating Temperature : 50°F ~ 104°F (10°C ~ 40°C) Operating Humidity : 10% ~ 80% Storage Temperature : -4°F ~ 113°F (-20°C ~ 45°C) Storage Humidity : 5% ~ 95%	
Audio Specifications	MAX Internal Audio Output Power : Each 10 W(Left/Right) Equalizer : 5 Band Output Frequency : • RF : 20 Hz ~ 15.4 kHz • AV/Componet/HDMI : 20 Hz ~ 20 kHz	
Note : Game Mode, smart hub, Energy Saving, Ultra slim		

Model	UE40ES55***	
Feature		
<ul style="list-style-type: none"> • Digital-TV, RF, 3-HDMI, 1-SCART, 1-Component, 1-A/V, 2-USB2.0(AllShare Play), LAN • High Contrast Ratio : Mega Contrast • Dynamic contrast, Super-PVA • Response Time : 8 ms • CMR : 100 • PIP (in HDMI 1, 2, 3 Component and Sub picture is available only in TV mode(DTV/ATV)) • Dolby Digital Plus/ DolbyPulse, SRS TheaterSound HD 		
Specifications		
Item	Description	
LCD Panel	40 inch FHD 60Hz	
Scanning Frequency	Horizontal : 50 kHz ~ 73 kHz (Automatic) Vertical : 47 Hz ~ 63 Hz (Automatic)	
Display Colors	16.7M colors	
Maximum Resolution	Horizontal : 1920 Pixels Vertical : 1080 Pixels	
Input Signal	Analog 0.7 Vp-p \pm 5% positive at 75 Ω , internally terminated	
Input Sync Signal	H/V Separate, TTL, P. or N.	
Maximum Pixel Clock Rate	74.25 MHz	
Active Display (H x V)* * Horizontal x Vertical	885.6(H) X 498.2(V) (mm) / 34.87(H) X 19.61(V) (inches)	
AC Power Voltage & Frequency	AC 220 V ~ 240 V, 50 / 60 Hz (Europe area) AC 100 V ~ 240 V, 50 / 60 Hz (CIS area)	
Power Consumption	92 W (Under 0.3 W, Stand by) Europe area 99 W (Under 0.3 W, Stand by) CIS area	
System	TV	Analogue :B/G, D/K, L, I(Depending on your country selection) Digital: DVB-T/DVB-C *UK, Nordic, Russia, UKR Area : DVB-T2/DVB-C *Russia, UKR Area Model Code: UE40ES55*7KXRU(UA)
	Colour Video	Analogue: PAL, SECAM, NTSC-4.43, NTSC-3.58, PAL60 Digital: MPEG-2 MP@ML, MPEG-4, H.264/AVC MP@L3 MP@L4.0, HP@L4.0
	Sound	BG, DK, L, NICAM, MPEG1, DD, DD+, HEAAC

2. Product specifications

Specifications	
Item	Description
Environmental Considerations	Operating Temperature : 50°F ~ 104°F (10°C ~ 40°C) Operating Humidity : 10% ~ 80% Storage Temperature : -4°F ~ 113°F (-20°C ~ 45°C) Storage Humidity : 5% ~ 95%
Audio Specifications	MAX Internal Audio Output Power : Each 10 W(Left/Right) Equalizer : 5 Band Output Frequency : <ul style="list-style-type: none">• RF : 20 Hz ~ 15.4 kHz• AV/Componet/HDMI : 20 Hz ~ 20 kHz
Note : Game Mode, smart hub, Energy Saving, Ultra slim	

Model	UE46ES55***	
Feature		
<ul style="list-style-type: none"> • Digital-TV, RF, 3-HDMI, 1-SCART, 1-Component, 1-A/V, 2-USB2.0(AllShare Play), LAN • High Contrast Ratio : Mega Contrast • Dynamic contrast, Super-PVA • Response Time : 8 ms • CMR : 100 • PIP (in HDMI 1, 2, 3 Component and Sub picture is available only in TV mode(DTV/ATV)) • Dolby Digital Plus/ DolbyPulse, SRS TheaterSound HD 		
Specifications		
Item	Description	
LCD Panel	46 inch FHD 60Hz	
Scanning Frequency	Horizontal : 50 kHz ~ 73 kHz (Automatic) Vertical : 47 Hz ~ 63 Hz (Automatic)	
Display Colors	16.7M colors	
Maximum Resolution	Horizontal : 1920 Pixels Vertical : 1080 Pixels	
Input Signal	Analog 0.7 Vp-p \pm 5% positive at 75 Ω , internally terminated	
Input Sync Signal	H/V Separate, TTL, P. or N.	
Maximum Pixel Clock Rate	74.25 MHz	
Active Display (H x V)* * Horizontal x Vertical	1018.1(H) X 572.7(V) (mm) / 40.08(H) X 22.55(V) (inches)	
AC Power Voltage & Frequency	AC 220 V ~ 240 V, 50 / 60 Hz (Europe area) AC 100 V ~ 240 V, 50 / 60 Hz (CIS area)	
Power Consumption	98 W (Under 0.3 W, Stand by) Europe area 100 W (Under 0.3 W, Stand by) CIS area	
System	TV	Analogue :B/G, D/K, L, I(Depending on your country selection) Digital: DVB-T/DVB-C *UK, Nordic, Russia, UKR Area : DVB-T2/DVB-C *Russia, UKR Area Model Code: UE46ES55*7KXRU(UA)
	Colour Video	Analogue: PAL, SECAM, NTSC-4.43, NTSC-3.58, PAL60 Digital: MPEG-2 MP@ML, MPEG-4, H.264/AVC MP@L3 MP@L4.0, HP@L4.0
	Sound	BG, DK, L, NICAM, MPEG1, DD, DD+, HEAAC

2. Product specifications

Specifications	
Item	Description
Environmental Considerations	Operating Temperature : 50°F ~ 104°F (10°C ~ 40°C) Operating Humidity : 10% ~ 80% Storage Temperature : -4°F ~ 113°F (-20°C ~ 45°C) Storage Humidity : 5% ~ 95%
Audio Specifications	MAX Internal Audio Output Power : Each 10 W(Left/Right) Equalizer : 5 Band Output Frequency : <ul style="list-style-type: none">• RF : 20 Hz ~ 15.4 kHz• AV/Componet/HDMI : 20 Hz ~ 20 kHz
Note : Game Mode, smart hub, Energy Saving, Ultra slim	

Model	UE50ES55***	
Feature		
<ul style="list-style-type: none"> • Digital-TV, RF, 3-HDMI, 1-SCART, 1-Component, 1-A/V, 2-USB2.0(AllShare Play), LAN • High Contrast Ratio : Mega Contrast • Dynamic contrast, Super-PVA • Response Time : 8 ms • CMR : 100 • PIP (in HDMI 1, 2, 3 Component and Sub picture is available only in TV mode(DTV/ATV)) • Dolby Digital Plus/ DolbyPulse, SRS TheaterSound HD 		
Specifications		
Item	Description	
LCD Panel	50 inch FHD 60Hz	
Scanning Frequency	Horizontal : 50 kHz ~ 73 kHz (Automatic) Vertical : 47 Hz ~ 63 Hz (Automatic)	
Display Colors	16.7M colors	
Maximum Resolution	Horizontal : 1920 Pixels Vertical : 1080 Pixels	
Input Signal	Analog 0.7 Vp-p \pm 5% positive at 75 Ω , internally terminated	
Input Sync Signal	H/V Separate, TTL, P. or N.	
Maximum Pixel Clock Rate	74.25 MHz	
Active Display (H x V)* * Horizontal x Vertical	1095.8(H) X 616.4(V) (mm) / 43.14(H) X 24.27(V) (inches)	
AC Power Voltage & Frequency	AC 220 V ~ 240 V, 50 / 60 Hz (Europe area) AC 100 V ~ 240 V, 50 / 60 Hz (CIS area)	
Power Consumption	117 W (Under 0.3 W, Stand by) Europe area 121 W (Under 0.3 W, Stand by) CIS area	
System	TV	Analogue :B/G, D/K, L, I(Depending on your country selection) Digital: DVB-T/DVB-C *UK, Nordic, Russia, UKR Area : DVB-T2/DVB-C *Russia, UKR Area Model Code: UE46ES55*7KXRU(UA)
	Colour Video	Analogue: PAL, SECAM, NTSC-4.43, NTSC-3.58, PAL60 Digital: MPEG-2 MP@ML, MPEG-4, H.264/AVC MP@L3 MP@L4.0, HP@L4.0
	Sound	BG, DK, L, NICAM, MPEG1, DD, DD+, HEAAC

2. Product specifications

Specifications	
Item	Description
Environmental Considerations	Operating Temperature : 50°F ~ 104°F (10°C ~ 40°C) Operating Humidity : 10% ~ 80% Storage Temperature : -4°F ~ 113°F (-20°C ~ 45°C) Storage Humidity : 5% ~ 95%
Audio Specifications	MAX Internal Audio Output Power : Each 10 W(Left/Right) Equalizer : 5 Band Output Frequency : <ul style="list-style-type: none">• RF : 20 Hz ~ 15.4 kHz• AV/Componet/HDMI : 20 Hz ~ 20 kHz
Note : Game Mode, smart hub, Energy Saving, Ultra slim	

Model	UE32ES57*** / UE32ES58***	
Feature		
<ul style="list-style-type: none"> • Digital-TV, RF, 3-HDMI, 1-SCART, 1-Component, 1-A/V, 2-USB2.0(AllShare Play), LAN • High Contrast Ratio : Mega Contrast • Dynamic contrast, Super-PVA • Response Time : 8 ms • CMR : 100 • PIP (in HDMI 1, 2, 3 Component and Sub picture is available only in TV mode(DTV/ATV)) • Dolby Digital Plus/ DolbyPulse, SRS TheaterSound HD 		
Specifications		
Item	Description	
LCD Panel	32 inch FHD 60Hz	
Scanning Frequency	Horizontal : 50 kHz ~ 73 kHz (Automatic) Vertical : 47 Hz ~ 63 Hz (Automatic)	
Display Colors	16.7M colors	
Maximum Resolution	Horizontal : 1920 Pixels Vertical : 1080 Pixels	
Input Signal	Analog 0.7 Vp-p \pm 5% positive at 75 Ω , internally terminated	
Input Sync Signal	H/V Separate, TTL, P. or N.	
Maximum Pixel Clock Rate	74.25 MHz	
Active Display (H x V)* * Horizontal x Vertical	698.4(H) X 392.9(V) (mm) / 27.5(H) X 15.47(V) (inches)	
AC Power Voltage & Frequency	AC 220 V ~ 240 V, 50 / 60 Hz	
Power Consumption	75 W (Under 0.3 W, Stand by)	
System	TV	Analogue :B/G, D/K, L, I(Depending on your country selection) Digital: DVB-T/DVB-C/DVB-S2
	Colour Video	Analogue: PAL, SECAM, NTSC-4.43, NTSC-3.58, PAL60 Digital: MPEG-2 MP@ML, MPEG-4, H.264/AVC MP@L3 MP@L4.0, HP@L4.0
	Sound	BG, DK, L, NICAM, MPEG1, DD, DD+, HEAAC
Environmental Considerations	Operating Temperature : 50°F ~ 104°F (10°C ~ 40°C) Operating Humidity : 10% ~ 80% Storage Temperature : -4°F ~ 113°F (-20°C ~ 45°C) Storage Humidity : 5% ~ 95%	
Audio Specifications	MAX Internal Audio Output Power : Each 10 W(Left/Right) Equalizer : 5 Band Output Frequency : <ul style="list-style-type: none"> • RF : 20 Hz ~ 15.4 kHz • AV/Componet/HDMI : 20 Hz ~ 20 kHz 	
Note : Game Mode, smart hub, Energy Saving, Ultra slim		

2. Product specifications

Model	UE37ES57***	
Feature		
<ul style="list-style-type: none"> • Digital-TV, RF, 3-HDMI, 1-SCART, 1-Component, 1-A/V, 2-USB2.0(AllShare Play), LAN • High Contrast Ratio : Mega Contrast • Dynamic contrast, Super-PVA • Response Time : 8 ms • CMR : 100 • PIP (in HDMI 1, 2, 3 Component and Sub picture is available only in TV mode(DTV/ATV)) • Dolby Digital Plus/ DolbyPulse, SRS TheaterSound HD 		
Specifications		
Item	Description	
LCD Panel	37inch FHD 60Hz	
Scanning Frequency	Horizontal : 50 kHz ~ 73 kHz (Automatic) Vertical : 47 Hz ~ 63 Hz (Automatic)	
Display Colors	16.7M colors	
Maximum Resolution	Horizontal : 1920 Pixels Vertical : 1080 Pixels	
Input Signal	Analog 0.7 Vp-p ± 5% positive at 75Ω, internally terminated	
Input Sync Signal	H/V Separate, TTL, P. or N.	
Maximum Pixel Clock Rate	74.25 MHz	
Active Display (H x V)* <small>* Horizontal x Vertical</small>	819.4(H) X 460.9(V) (mm) / 32.26(H) X 18.15(V) (inches)	
AC Power Voltage & Frequency	AC 220 V ~ 240 V, 50 / 60 Hz	
Power Consumption	94 W (Under 0.3 W, Stand by)	
System	TV	Analogue :B/G, D/K, L, I(Depending on your country selection) Digital: DVB-T/DVB-C/DVB-S2
	Colour Video	Analogue: PAL, SECAM, NTSC-4.43, NTSC-3.58, PAL60 Digital: MPEG-2 MP@ML, MPEG-4, H.264/AVC MP@L3 MP@L4.0, HP@L4.0
	Sound	BG, DK, L, NICAM, MPEG1, DD, DD+, HEAAC
Environmental Considerations	Operating Temperature : 50°F ~ 104°F (10°C ~ 40°C) Operating Humidity : 10% ~ 80% Storage Temperature : -4°F ~ 113°F (-20°C ~ 45°C) Storage Humidity : 5% ~ 95%	
Audio Specifications	MAX Internal Audio Output Power : Each 10 W(Left/Right) Equalizer : 5 Band Output Frequency : <ul style="list-style-type: none"> • RF : 20 Hz ~ 15.4 kHz • AV/Componet/HDMI : 20 Hz ~ 20 kHz 	
Note : Game Mode, smart hub, Energy Saving, Ultra slim		

Model	UE40ES57***/ UE40ES58***	
Feature		
<ul style="list-style-type: none"> • Digital-TV, RF, 3-HDMI, 1-SCART, 1-Component, 1-A/V, 2-USB2.0(AllShare Play), LAN • High Contrast Ratio : Mega Contrast • Dynamic contrast, Super-PVA • Response Time : 8 ms • CMR : 100 • PIP (in HDMI 1, 2, 3 Component and Sub picture is available only in TV mode(DTV/ATV)) • Dolby Digital Plus/ DolbyPulse, SRS TheaterSound HD 		
Specifications		
Item	Description	
LCD Panel	40 inch FHD 60Hz	
Scanning Frequency	Horizontal : 50 kHz ~ 73 kHz (Automatic) Vertical : 47 Hz ~ 63 Hz (Automatic)	
Display Colors	16.7M colors	
Maximum Resolution	Horizontal : 1920 Pixels Vertical : 1080 Pixels	
Input Signal	Analog 0.7 Vp-p \pm 5% positive at 75 Ω , internally terminated	
Input Sync Signal	H/V Separate, TTL, P. or N.	
Maximum Pixel Clock Rate	74.25 MHz	
Active Display (H x V)* * Horizontal x Vertical	885.6(H) X 498.9(V) (mm) / 34.87(H) X 19.61(V) (inches)	
AC Power Voltage & Frequency	AC 220 V ~ 240 V, 50 / 60 Hz	
Power Consumption	92 W (Under 0.3 W, Stand by)	
System	TV	Analogue :B/G, D/K, L, I(Depending on your country selection) Digital: DVB-T/DVB-C/DVB-S2
	Colour Video	Analogue: PAL, SECAM, NTSC-4.43, NTSC-3.58, PAL60 Digital: MPEG-2 MP@ML, MPEG-4, H.264/AVC MP@L3 MP@L4.0, HP@L4.0
	Sound	BG, DK, L, NICAM, MPEG1, DD, DD+, HEAAC
Environmental Considerations	Operating Temperature : 50°F ~ 104°F (10°C ~ 40°C) Operating Humidity : 10% ~ 80% Storage Temperature : -4°F ~ 113°F (-20°C ~ 45°C) Storage Humidity : 5% ~ 95%	
Audio Specifications	MAX Internal Audio Output Power : Each 10 W(Left/Right) Equalizer : 5 Band Output Frequency : <ul style="list-style-type: none"> • RF : 20 Hz ~ 15.4 kHz • AV/Componet/HDMI : 20 Hz ~ 20 kHz 	
Note : Game Mode, smart hub, Energy Saving, Ultra slim		

2. Product specifications

Model	UE46ES57*** / UE46ES58***	
Feature		
<ul style="list-style-type: none"> • Digital-TV, RF, 3-HDMI, 1-SCART, 1-Component, 1-A/V, 2-USB2.0(AllShare Play), LAN • High Contrast Ratio : Mega Contrast • Dynamic contrast, Super-PVA • Response Time : 8 ms • CMR : 100 • PIP (in HDMI 1, 2, 3 Component and Sub picture is available only in TV mode(DTV/ATV)) • Dolby Digital Plus/ DolbyPulse, SRS TheaterSound HD 		
Specifications		
Item	Description	
LCD Panel	46 inch FHD 60Hz	
Scanning Frequency	Horizontal : 50 kHz ~ 73 kHz (Automatic) Vertical : 47 Hz ~ 63 Hz (Automatic)	
Display Colors	16.7M colors	
Maximum Resolution	Horizontal : 1920 Pixels Vertical : 1080 Pixels	
Input Signal	Analog 0.7 Vp-p ± 5% positive at 75Ω, internally terminated	
Input Sync Signal	H/V Separate, TTL, P. or N.	
Maximum Pixel Clock Rate	74.25 MHz	
Active Display (H x V)* * Horizontal x Vertical	1018.1(H) X 572.7(V) (mm) / 40.08(H) X 22.55(V) (inches)	
AC Power Voltage & Frequency	AC 220 V ~ 240 V, 50 / 60 Hz	
Power Consumption	98 W (Under 0.3 W, Stand by)	
System	TV	Analogue :B/G, D/K, L, I(Depending on your country selection) Digital: DVB-T/DVB-C/DVB-S2
	Colour Video	Analogue: PAL, SECAM, NTSC-4.43, NTSC-3.58, PAL60 Digital: MPEG-2 MP@ML, MPEG-4, H.264/AVC MP@L3 MP@L4.0, HP@L4.0
	Sound	BG, DK, L, NICAM, MPEG1, DD, DD+, HEAAC
Environmental Considerations	Operating Temperature : 50°F ~ 104°F (10°C ~ 40°C) Operating Humidity : 10% ~ 80% Storage Temperature : -4°F ~ 113°F (-20°C ~ 45°C) Storage Humidity : 5% ~ 95%	
Audio Specifications	MAX Internal Audio Output Power : Each 10 W(Left/Right) Equalizer : 5 Band Output Frequency : • RF : 20 Hz ~ 15.4 kHz • AV/Componet/HDMI : 20 Hz ~ 20 kHz	
Note : Game Mode, smart hub, Energy Saving, Ultra slim		

Model	UE50ES57***	
Feature		
<ul style="list-style-type: none"> • Digital-TV, RF, 3-HDMI, 1-SCART, 1-Component, 1-A/V, 2-USB2.0(AllShare Play), LAN • High Contrast Ratio : Mega Contrast • Dynamic contrast, Super-PVA • Response Time : 8 ms • CMR : 100 • PIP (in HDMI 1, 2, 3 Component and Sub picture is available only in TV mode(DTV/ATV)) • Dolby Digital Plus/ DolbyPulse, SRS TheaterSound HD 		
Specifications		
Item	Description	
LCD Panel	50 inch FHD 60Hz	
Scanning Frequency	Horizontal : 50 kHz ~ 73 kHz (Automatic) Vertical : 47 Hz ~ 63 Hz (Automatic)	
Display Colors	16.7M colors	
Maximum Resolution	Horizontal : 1920 Pixels Vertical : 1080 Pixels	
Input Signal	Analog 0.7 Vp-p \pm 5% positive at 75 Ω , internally terminated	
Input Sync Signal	H/V Separate, TTL, P. or N.	
Maximum Pixel Clock Rate	74.25 MHz	
Active Display (H x V)* * Horizontal x Vertical	1095.8(H) X 616.4(V) (mm) / 43.14(H) X 24.27(V) (inches)	
AC Power Voltage & Frequency	AC 220 V ~ 240 V, 50 / 60 Hz	
Power Consumption	117 W (Under 0.3 W, Stand by)	
System	TV	Analogue :B/G, D/K, L, I(Depending on your country selection) Digital: DVB-T/DVB-C/DVB-S2
	Colour Video	Analogue: PAL, SECAM, NTSC-4.43, NTSC-3.58, PAL60 Digital: MPEG-2 MP@ML, MPEG-4, H.264/AVC MP@L3 MP@L4.0, HP@L4.0
	Sound	BG, DK, L, NICAM, MPEG1, DD, DD+, HEAAC
Environmental Considerations	Operating Temperature : 50°F ~ 104°F (10°C ~ 40°C) Operating Humidity : 10% ~ 80% Storage Temperature : -4°F ~ 113°F (-20°C ~ 45°C) Storage Humidity : 5% ~ 95%	
Audio Specifications	MAX Internal Audio Output Power : Each 10 W(Left/Right) Equalizer : 5 Band Output Frequency : <ul style="list-style-type: none"> • RF : 20 Hz ~ 15.4 kHz • AV/Componet/HDMI : 20 Hz ~ 20 kHz 	
Note : Game Mode, smart hub, Energy Saving, Ultra slim		

2. Product specifications

Model	UE32EH53***	
Feature		
<ul style="list-style-type: none"> • Digital-TV, RF, 3-HDMI, 1-SCART, 1-Component, 1-A/V, 2-USB2.0(AllShare Play), LAN • High Contrast Ratio : Mega Contrast • Dynamic contrast, Super-PVA • Response Time : 8 ms • CMR : 100 • PIP (in HDMI 1, 2, 3 Component and Sub picture is available only in TV mode(DTV/ATV)) • Dolby Digital Plus/ DolbyPulse, SRS TheaterSound HD 		
Specifications		
Item	Description	
LCD Panel	32 inch FHD 60Hz	
Scanning Frequency	Horizontal : 50 kHz ~ 73 kHz (Automatic) Vertical : 47 Hz ~ 63 Hz (Automatic)	
Display Colors	16.7M colors	
Maximum Resolution	Horizontal : 1920 Pixels Vertical : 1080 Pixels	
Input Signal	Analog 0.7 Vp-p ± 5% positive at 75Ω, internally terminated	
Input Sync Signal	H/V Separate, TTL, P. or N.	
Maximum Pixel Clock Rate	74.25 MHz	
Active Display (H x V)* * Horizontal x Vertical	698.4(H) X 392.9(V) (mm) / 27.5(H) X 15.47(V) (inches)	
AC Power Voltage & Frequency	AC 220 V ~ 240 V, 50 / 60 Hz (Europe area) AC 100 V ~ 240 V, 50 / 60 Hz (CIS area)	
Power Consumption	67 W (Under 0.3 W, Stand by) Europe area 69 W (Under 0.3 W, Stand by) CIS area	
System	TV	Analogue :B/G, D/K, L, I(Depending on your country selection) Digital: DVB-T/DVB-C *UK, Nordic, Russia, UKR Area : DVB-T2/DVB-C *Russia, UKR Area Model Code: UE32EH5307KXRU(UA)
	Colour Video	Analogue: PAL, SECAM, NTSC-4.43, NTSC-3.58, PAL60 Digital: MPEG-2 MP@ML, MPEG-4, H.264/AVC MP@L3 MP@L4.0, HP@L4.0
	Sound	BG, DK, L, NICAM, MPEG1, DD, DD+, HEAAC

Specifications	
Item	Description
Environmental Considerations	Operating Temperature : 50°F ~ 104°F (10°C ~ 40°C) Operating Humidity : 10% ~ 80% Storage Temperature : -4°F ~ 113°F (-20°C ~ 45°C) Storage Humidity : 5% ~ 95%
Audio Specifications	MAX Internal Audio Output Power : Each 10 W(Left/Right) Equalizer : 5 Band Output Frequency : <ul style="list-style-type: none"> • RF : 20 Hz ~ 15.4 kHz • AV/Componet/HDMI : 20 Hz ~ 20 kHz
Note : Game Mode, smart hub, Energy Saving	

2. Product specifications

Model	UE37EH53***	
Feature		
<ul style="list-style-type: none"> • Digital-TV, RF, 3-HDMI, 1-SCART, 1-Component, 1-A/V, 2-USB2.0(AllShare Play), LAN • High Contrast Ratio : Mega Contrast • Dynamic contrast, Super-PVA • Response Time : 8 ms • CMR : 100 • PIP (in HDMI 1, 2, 3 Component and Sub picture is available only in TV mode(DTV/ATV)) • Dolby Digital Plus/ DolbyPulse, SRS TheaterSound HD 		
Specifications		
Item	Description	
LCD Panel	37 inch FHD 60Hz	
Scanning Frequency	Horizontal : 50 kHz ~ 73 kHz (Automatic) Vertical : 47 Hz ~ 63 Hz (Automatic)	
Display Colors	16.7M colors	
Maximum Resolution	Horizontal : 1920 Pixels Vertical : 1080 Pixels	
Input Signal	Analog 0.7 Vp-p ± 5% positive at 75Ω, internally terminated	
Input Sync Signal	H/V Separate, TTL, P. or N.	
Maximum Pixel Clock Rate	74.25 MHz	
Active Display (H x V)* <small>* Horizontal x Vertical</small>	819.4(H) X 460.9(V) (mm) / 32.26(H) X 18.15(V) (inches)	
AC Power Voltage & Frequency	AC 220 V ~ 240 V, 50 / 60 Hz (Europe area) AC 100 V ~ 240 V, 50 / 60 Hz (CIS area)	
Power Consumption	TBD W (Under 0.3 W, Stand by)	
System	TV	Analogue :B/G, D/K, L, I(Depending on your country selection) Digital: DVB-T/DVB-C *UK Area : DVB-T2/DVB-C
	Colour Video	Analogue: PAL, SECAM, NTSC-4.43, NTSC-3.58, PAL60 Digital: MPEG-2 MP@ML, MPEG-4, H.264/AVC MP@L3 MP@L4.0, HP@L4.0
	Sound	BG, DK, L, NICAM, MPEG1, DD, DD+, HEAAC

Specifications	
Item	Description
Environmental Considerations	Operating Temperature : 50°F ~ 104°F (10°C ~ 40°C) Operating Humidity : 10% ~ 80% Storage Temperature : -4°F ~ 113°F (-20°C ~ 45°C) Storage Humidity : 5% ~ 95%
Audio Specifications	MAX Internal Audio Output Power : Each 10 W(Left/Right) Equalizer : 5 Band Output Frequency : <ul style="list-style-type: none"> • RF : 20 Hz ~ 15.4 kHz • AV/Componet/HDMI : 20 Hz ~ 20 kHz
Note : Game Mode, smart hub, Energy Saving	

2. Product specifications

Model	UE40EH53***	
Feature		
<ul style="list-style-type: none"> • Digital-TV, RF, 3-HDMI, 1-SCART, 1-Component, 1-A/V, 2-USB2.0(AllShare Play), LAN • High Contrast Ratio : Mega Contrast • Dynamic contrast, Super-PVA • Response Time : 8 ms • CMR : 100 • PIP (in HDMI 1, 2, 3 Component and Sub picture is available only in TV mode(DTV/ATV)) • Dolby Digital Plus/ DolbyPulse, SRS TheaterSound HD 		
Specifications		
Item	Description	
LCD Panel	40 inch FHD 60Hz	
Scanning Frequency	Horizontal : 50 kHz ~ 73 kHz (Automatic) Vertical : 47 Hz ~ 63 Hz (Automatic)	
Display Colors	16.7M colors	
Maximum Resolution	Horizontal : 1920 Pixels Vertical : 1080 Pixels	
Input Signal	Analog 0.7 Vp-p ± 5% positive at 75Ω, internally terminated	
Input Sync Signal	H/V Separate, TTL, P. or N.	
Maximum Pixel Clock Rate	74.25 MHz	
Active Display (H x V)* * Horizontal x Vertical	885.6(H) X 498.2(V) (mm) / 34.87(H) X 19.61(V) (inches)	
AC Power Voltage & Frequency	AC 220 V ~ 240 V, 50 / 60 Hz (Europe area) AC 100 V ~ 240 V, 50 / 60 Hz (CIS area)	
Power Consumption	87 W (Under 0.3 W, Stand by) Europe area 89 W (Under 0.3 W, Stand by) CIS area	
System	TV	Analogue :B/G, D/K, L, I(Depending on your country selection) Digital: DVB-T/DVB-C * UK, Nordic, Russia, UKR Area : DVB-T2/DVB-C * Russia, UKR Area Model Code: UE40EH5307KXRU(UA)
	Colour Video	Analogue: PAL, SECAM, NTSC-4.43, NTSC-3.58, PAL60 Digital: MPEG-2 MP@ML, MPEG-4, H.264/AVC MP@L3 MP@L4.0, HP@L4.0
	Sound	BG, DK, L, NICAM, MPEG1, DD, DD+, HEAAC

Specifications	
Item	Description
Environmental Considerations	Operating Temperature : 50°F ~ 104°F (10°C ~ 40°C) Operating Humidity : 10% ~ 80% Storage Temperature : -4°F ~ 113°F (-20°C ~ 45°C) Storage Humidity : 5% ~ 95%
Audio Specifications	MAX Internal Audio Output Power : Each 10 W(Left/Right) Equalizer : 5 Band Output Frequency : <ul style="list-style-type: none"> • RF : 20 Hz ~ 15.4 kHz • AV/Componet/HDMI : 20 Hz ~ 20 kHz
Note : Game Mode, smart hub, Energy Saving	

Model	UE46EH53***	
Feature		
<ul style="list-style-type: none"> • Digital-TV, RF, 3-HDMI, 1-SCART, 1-Component, 1-A/V, 2-USB2.0(AllShare Play), LAN • High Contrast Ratio : Mega Contrast • Dynamic contrast, Super-PVA • Response Time : 8 ms • CMR : 100 • PIP (in HDMI 1, 2, 3 Component and Sub picture is available only in TV mode(DTV/ATV)) • Dolby Digital Plus/ DolbyPulse, SRS TheaterSound HD 		
Specifications		
Item	Description	
LCD Panel	46 inch FHD 60Hz	
Scanning Frequency	Horizontal : 50 kHz ~ 73 kHz (Automatic) Vertical : 47 Hz ~ 63 Hz (Automatic)	
Display Colors	16.7M colors	
Maximum Resolution	Horizontal : 1920 Pixels Vertical : 1080 Pixels	
Input Signal	Analog 0.7 Vp-p \pm 5% positive at 75 Ω , internally terminated	
Input Sync Signal	H/V Separate, TTL, P. or N.	
Maximum Pixel Clock Rate	74.25 MHz	
Active Display (H x V)* * Horizontal x Vertical	1018.1(H) X 572.7(V) (mm) / 40.08(H) X 22.55(V) (inches)	
AC Power Voltage & Frequency	AC 220 V ~ 240 V, 50 / 60 Hz (Europe area) AC 100 V ~ 240 V, 50 / 60 Hz (CIS area)	
Power Consumption	96 W (Under 0.3 W, Stand by) Europe area 99 W (Under 0.3 W, Stand by) CIS area	
System	TV	Analogue :B/G, D/K, L, I(Depending on your country selection) Digital: DVB-T/DVB-C *UK, Nordic, Russia, UKR Area : DVB-T2/DVB-C *Russia, UKR Area Model Code: UE46EH5307KXRU(UA)
	Colour Video	Analogue: PAL, SECAM, NTSC-4.43, NTSC-3.58, PAL60 Digital: MPEG-2 MP@ML, MPEG-4, H.264/AVC MP@L3 MP@L4.0, HP@L4.0
	Sound	BG, DK, L, NICAM, MPEG1, DD, DD+, HEAAC

Specifications	
Item	Description
Environmental Considerations	Operating Temperature : 50°F ~ 104°F (10°C ~ 40°C) Operating Humidity : 10% ~ 80% Storage Temperature : -4°F ~ 113°F (-20°C ~ 45°C) Storage Humidity : 5% ~ 95%
Audio Specifications	MAX Internal Audio Output Power : Each 10 W(Left/Right) Equalizer : 5 Band Output Frequency : <ul style="list-style-type: none"> • RF : 20 Hz ~ 15.4 kHz • AV/Componet/HDMI : 20 Hz ~ 20 kHz
Note : Game Mode, smart hub, Energy Saving	

2. Product specifications

Model	UE50EH53***	
Feature		
<ul style="list-style-type: none"> • Digital-TV, RF, 3-HDMI, 1-SCART, 1-Component, 1-A/V, 2-USB2.0(AllShare Play), LAN • High Contrast Ratio : Mega Contrast • Dynamic contrast, Super-PVA • Response Time : 8 ms • CMR : 100 • PIP (in HDMI 1, 2, 3 Component and Sub picture is available only in TV mode(DTV/ATV)) • Dolby Digital Plus/ DolbyPulse, SRS TheaterSound HD 		
Specifications		
Item	Description	
LCD Panel	50 inch FHD 60Hz	
Scanning Frequency	Horizontal : 50 kHz ~ 73 kHz (Automatic) Vertical : 47 Hz ~ 63 Hz (Automatic)	
Display Colors	16.7M colors	
Maximum Resolution	Horizontal : 1920 Pixels Vertical : 1080 Pixels	
Input Signal	Analog 0.7 Vp-p ± 5% positive at 75Ω, internally terminated	
Input Sync Signal	H/V Separate, TTL, P. or N.	
Maximum Pixel Clock Rate	74.25 MHz	
Active Display (H x V)* * Horizontal x Vertical	1095.8(H) X 616.4(V) (mm) / 43.14(H) X 24.27(V) (inches)	
AC Power Voltage & Frequency	AC 220 V ~ 240 V, 50 / 60 Hz	
Power Consumption	116 W (Under 0.3 W, Stand by)	
System	TV	Analogue :B/G, D/K, L, I(Depending on your country selection) Digital: DVB-T/DVB-C *UK, Nordic Area : DVB-T2/DVB-C
	Colour Video	Analogue: PAL, SECAM, NTSC-4.43, NTSC-3.58, PAL60 Digital: MPEG-2 MP@ML, MPEG-4, H.264/AVC MP@L3 MP@L4.0, HP@L4.0
	Sound	BG, DK, L, NICAM, MPEG1, DD, DD+, HEAAC
Environmental Considerations	Operating Temperature : 50°F ~ 104°F (10°C ~ 40°C) Operating Humidity : 10% ~ 80% Storage Temperature : -4°F ~ 113°F (-20°C ~ 45°C) Storage Humidity : 5% ~ 95%	
Audio Specifications	MAX Internal Audio Output Power : Each 10 W(Left/Right) Equalizer : 5 Band Output Frequency : • RF : 20 Hz ~ 15.4 kHz • AV/Componet/HDMI : 20 Hz ~ 20 kHz	
Note : Game Mode, smart hub, Energy Saving		

Model	UE32EH5450W	
Feature		
<ul style="list-style-type: none"> • Digital-TV, RF, 3-HDMI, 1-SCART, 1-Component, 1-A/V, 2-USB2.0(AllShare Play), LAN • High Contrast Ratio : Mega Contrast • Dynamic contrast, Super-PVA • Response Time : 8 ms • CMR : 100 • PIP (in HDMI 1, 2, 3 Component and Sub picture is available only in TV mode(DTV/ATV)) • Dolby Digital Plus/ DolbyPulse, SRS TheaterSound HD 		
Specifications		
Item	Description	
LCD Panel	32 inch FHD 60Hz	
Scanning Frequency	Horizontal : 50 kHz ~ 73 kHz (Automatic) Vertical : 47 Hz ~ 63 Hz (Automatic)	
Display Colors	16.7M colors	
Maximum Resolution	Horizontal : 1920 Pixels Vertical : 1080 Pixels	
Input Signal	Analog 0.7 Vp-p \pm 5% positive at 75 Ω , internally terminated	
Input Sync Signal	H/V Separate, TTL, P. or N.	
Maximum Pixel Clock Rate	74.25 MHz	
Active Display (H x V)* * Horizontal x Vertical	698.4(H) X 392.9(V) (mm) / 27.5(H) X 15.47(V) (inches)	
AC Power Voltage & Frequency	AC 220 V ~ 240 V, 50 / 60 Hz	
Power Consumption	67 W (Under 0.3 W, Stand by)	
System	TV	Analogue :B/G, D/K, L, I(Depending on your country selection) Digital: DVB-T/DVB-C *UK, Nordic Area : DVB-T2/DVB-C
	Colour Video	Analogue: PAL, SECAM, NTSC-4.43, NTSC-3.58, PAL60 Digital: MPEG-2 MP@ML, MPEG-4, H.264/AVC MP@L3 MP@L4.0, HP@L4.0
	Sound	BG, DK, L, NICAM, MPEG1, DD, DD+, HEAAC
Environmental Considerations	Operating Temperature : 50°F ~ 104°F (10°C ~ 40°C) Operating Humidity : 10% ~ 80% Storage Temperature : -4°F ~ 113°F (-20°C ~ 45°C) Storage Humidity : 5% ~ 95%	
Audio Specifications	MAX Internal Audio Output Power : Each 10 W(Left/Right) Equalizer : 5 Band Output Frequency : <ul style="list-style-type: none"> • RF : 20 Hz ~ 15.4 kHz • AV/Componet/HDMI : 20 Hz ~ 20 kHz 	
Note : Game Mode, smart hub, Energy Saving		

2. Product specifications

Model	UE40EH5450W	
Feature		
<ul style="list-style-type: none"> • Digital-TV, RF, 3-HDMI, 1-SCART, 1-Component, 1-A/V, 2-USB2.0(AllShare Play), LAN • High Contrast Ratio : Mega Contrast • Dynamic contrast, Super-PVA • Response Time : 8 ms • CMR : 100 • PIP (in HDMI 1, 2, 3 Component and Sub picture is available only in TV mode(DTV/ATV)) • Dolby Digital Plus/ DolbyPulse, SRS TheaterSound HD 		
Specifications		
Item	Description	
LCD Panel	40 inch FHD 60Hz	
Scanning Frequency	Horizontal : 50 kHz ~ 73 kHz (Automatic) Vertical : 47 Hz ~ 63 Hz (Automatic)	
Display Colors	16.7M colors	
Maximum Resolution	Horizontal : 1920 Pixels Vertical : 1080 Pixels	
Input Signal	Analog 0.7 Vp-p ± 5% positive at 75Ω, internally terminated	
Input Sync Signal	H/V Separate, TTL, P. or N.	
Maximum Pixel Clock Rate	74.25 MHz	
Active Display (H x V)* <small>* Horizontal x Vertical</small>	885.6(H) X 498.2(V) (mm) / 34.87(H) X 19.61(V) (inches)	
AC Power Voltage & Frequency	AC 220 V ~ 240 V, 50 / 60 Hz	
Power Consumption	87 W (Under 0.3 W, Stand by)	
System	TV	Analogue :B/G, D/K, L, I(Depending on your country selection) Digital: DVB-T/DVB-C *UK, Nordic Area : DVB-T2/DVB-C
	Colour Video	Analogue: PAL, SECAM, NTSC-4.43, NTSC-3.58, PAL60 Digital: MPEG-2 MP@ML, MPEG-4, H.264/AVC MP@L3 MP@L4.0, HP@L4.0
	Sound	BG, DK, L, NICAM, MPEG1, DD, DD+, HEAAC
Environmental Considerations	Operating Temperature : 50°F ~ 104°F (10°C ~ 40°C) Operating Humidity : 10% ~ 80% Storage Temperature : -4°F ~ 113°F (-20°C ~ 45°C) Storage Humidity : 5% ~ 95%	
Audio Specifications	MAX Internal Audio Output Power : Each 10 W(Left/Right) Equalizer : 5 Band Output Frequency : <ul style="list-style-type: none"> • RF : 20 Hz ~ 15.4 kHz • AV/Componet/HDMI : 20 Hz ~ 20 kHz 	
Note : Game Mode, smart hub, Energy Saving		



Model	UE46EH5450W	
Feature		
<ul style="list-style-type: none"> • Digital-TV, RF, 3-HDMI, 1-SCART, 1-Component, 1-A/V, 2-USB2.0(AllShare Play), LAN • High Contrast Ratio : Mega Contrast • Dynamic contrast, Super-PVA • Response Time : 8 ms • CMR : 100 • PIP (in HDMI 1, 2, 3 Component and Sub picture is available only in TV mode(DTV/ATV)) • Dolby Digital Plus/ DolbyPulse, SRS TheaterSound HD 		
Specifications		
Item	Description	
LCD Panel	46 inch FHD 60Hz	
Scanning Frequency	Horizontal : 50 kHz ~ 73 kHz (Automatic) Vertical : 47 Hz ~ 63 Hz (Automatic)	
Display Colors	16.7M colors	
Maximum Resolution	Horizontal : 1920 Pixels Vertical : 1080 Pixels	
Input Signal	Analog 0.7 Vp-p \pm 5% positive at 75 Ω , internally terminated	
Input Sync Signal	H/V Separate, TTL, P. or N.	
Maximum Pixel Clock Rate	74.25 MHz	
Active Display (H x V)* * Horizontal x Vertical	1018.1(H) X 572.7(V) (mm) / 40.08(H) X 22.55(V) (inches)	
AC Power Voltage & Frequency	AC 220 V ~ 240 V, 50 / 60 Hz	
Power Consumption	96 W (Under 0.3 W, Stand by)	
System	TV	Analogue :B/G, D/K, L, I(Depending on your country selection) Digital: DVB-T/DVB-C *UK, Nordic Area : DVB-T2/DVB-C
	Colour Video	Analogue: PAL, SECAM, NTSC-4.43, NTSC-3.58, PAL60 Digital: MPEG-2 MP@ML, MPEG-4, H.264/AVC MP@L3 MP@L4.0, HP@L4.0
	Sound	BG, DK, L, NICAM, MPEG1, DD, DD+, HEAAC
Environmental Considerations	Operating Temperature : 50°F ~ 104°F (10°C ~ 40°C) Operating Humidity : 10% ~ 80% Storage Temperature : -4°F ~ 113°F (-20°C ~ 45°C) Storage Humidity : 5% ~ 95%	
Audio Specifications	MAX Internal Audio Output Power : Each 10 W(Left/Right) Equalizer : 5 Band Output Frequency : <ul style="list-style-type: none"> • RF : 20 Hz ~ 15.4 kHz • AV/Componet/HDMI : 20 Hz ~ 20 kHz 	
Note : Game Mode, smart hub, Energy Saving		

2. Product specifications

Model	UE26EH45***	
Feature		
<ul style="list-style-type: none"> • Digital-TV, RF, 2-HDMI, 1-SCART, 1-Component, 1-A/V, 2-USB2.0(AllShare Play), LAN • High Contrast Ratio : Mega Contrast • Dynamic contrast, Super-PVA • Response Time : 8 ms • CMR : 100 • PIP (in HDMI 1, 2 Component and Sub picture is available only in TV mode(DTV/ATV)) • Dolby Digital Plus/ DolbyPulse, SRS TheaterSound HD 		
Specifications		
Item	Description	
LCD Panel	26 inch FHD 60Hz	
Scanning Frequency	Horizontal : 45 kHz ~ 73 kHz (Automatic) Vertical : 47 Hz ~ 63 Hz (Automatic)	
Display Colors	16.7M colors	
Maximum Resolution	Horizontal : 1366 Pixels Vertical : 768 Pixels	
Input Signal	Analog 0.7 Vp-p ± 5% positive at 75Ω, internally terminated	
Input Sync Signal	H/V Separate, TTL, P. or N.	
Maximum Pixel Clock Rate	74.25 MHz	
Active Display (H x V)* <small>* Horizontal x Vertical</small>	575.8(H) X 323.7(V) (mm) / 22.67(H) X 12.74(V) (inches)	
AC Power Voltage & Frequency	AC 220 V ~ 240 V, 50 / 60 Hz	
Power Consumption	40 W (Under 0.3 W, Stand by)	
System	TV	Analogue :B/G, D/K, L, I(Depending on your country selection) Digital: DVB-T/DVB-C
	Colour Video	Analogue: PAL, SECAM, NTSC-4.43, NTSC-3.58, PAL60 Digital: MPEG-2 MP@ML, MPEG-4, H.264/AVC MP@L3 MP@L4.0, HP@L4.0
	Sound	BG, DK, L, NICAM, MPEG1, DD, DD+, HEAAC
Environmental Considerations	Operating Temperature : 50°F ~ 104°F (10°C ~ 40°C) Operating Humidity : 10% ~ 80% Storage Temperature : -4°F ~ 113°F (-20°C ~ 45°C) Storage Humidity : 5% ~ 95%	
Audio Specifications	MAX Internal Audio Output Power : Each 5 W(Left/Right) Equalizer : 5 Band Output Frequency : <ul style="list-style-type: none"> • RF : 20 Hz ~ 15.4 kHz • AV/Componet/HDMI : 20 Hz ~ 20 kHz 	
Note : Game Mode, smart hub		



Model	UE22EH54***	
Feature		
<ul style="list-style-type: none"> • Digital-TV, RF, 1-HDMI, 1-SCART, 1-Component, 1-A/V, 2-USB2.0(AllShare Play), LAN • High Contrast Ratio : Mega Contrast • Dynamic contrast, Super-PVA • Response Time : 8 ms • CMR : 100 • PIP (in HDMI 1 Component and Sub picture is available only in TV mode(DTV/ATV)) • Dolby Digital Plus/ DolbyPulse, SRS TheaterSound HD 		
Specifications		
Item	Description	
LCD Panel	22 inch FHD 60Hz	
Scanning Frequency	Horizontal : 50 kHz ~ 73 kHz (Automatic) Vertical : 47 Hz ~ 63 Hz (Automatic)	
Display Colors	16.7M colors	
Maximum Resolution	Horizontal : 1920 Pixels Vertical : 1080 Pixels	
Input Signal	Analog 0.7 Vp-p \pm 5% positive at 75 Ω , internally terminated	
Input Sync Signal	H/V Separate, TTL, P. or N.	
Maximum Pixel Clock Rate	74.25 MHz	
Active Display (H x V)* * Horizontal x Vertical	476.6(H) X 268.1(V) (mm) / 18.77(H) X 10.56(V) (inches)	
AC Power Voltage & Frequency	AC 220 V ~ 240 V, 50 / 60 Hz	
Power Consumption	30 W (Under 0.3 W, Stand by)	
System	TV	Analogue :B/G, D/K, L, I(Depending on your country selection) Digital: DVB-T/DVB-C
	Colour Video	Analogue: PAL, SECAM, NTSC-4.43, NTSC-3.58, PAL60 Digital: MPEG-2 MP@ML, MPEG-4, H.264/AVC MP@L3 MP@L4.0, HP@L4.0
	Sound	BG, DK, L, NICAM, MPEG1, DD, DD+, HEAAC
Environmental Considerations	Operating Temperature : 50°F ~ 104°F (10°C ~ 40°C) Operating Humidity : 10% ~ 80% Storage Temperature : -4°F ~ 113°F (-20°C ~ 45°C) Storage Humidity : 5% ~ 95%	
Audio Specifications	MAX Internal Audio Output Power : Each 3 W(Left/Right) Equalizer : 5 Band Output Frequency : <ul style="list-style-type: none"> • RF : 20 Hz ~ 15.4 kHz • AV/Componet/HDMI : 20 Hz ~ 20 kHz 	
Note : Game Mode, smart hub		

2-1-3. Specification Comparison to Old Models

Model	UE5N(UE**ES55*** / 57*** / 58***) Slim LED		UD5R(UE**D5500R*) LED	
Design				
Display Type	LED TV 2D		LED TV 2D	
Built-in Tuner	○		○	
Resolution	1920 x 1080		1920 x 1080	
LCD Panel	TFT LCD Panel 60 Hz		TFT LCD Panel 60 Hz	
Picture ratio	16 : 9		16 : 9	
Power Consumption	32"	75 W / 78 W (Under 0.3W, Standby)	32"	68 W (Under 0.3W, Standby)
	37"	94 W (Under 0.3W, Standby)	37"	90 W (Under 0.3W, Standby)
	40"	92 W / 99 W (Under 0.3W, Standby)	40"	103 W (Under 0.3W, Standby)
	46"	98 W / 100 W (Under 0.3W, Standby)	46"	134 W (Under 0.3W, Standby)
	50"	117 W / 121 W (Under 0.3W, Standby)		
Brightness	32"	319 cd / m ²	32"	286 cd / m ²
	37"	325 cd / m ²	37"	324 cd / m ²
	40"	328 cd / m ²	40"	318 cd / m ²
	46"	324 cd / m ²	46"	383 cd / m ²
	50"	333 cd / m ²		
Dimensions (W x H x D)	32"	29.1 x 19.3 x 7.1 inches_with stand 29.1 x 17.7 x 1.8 inches_without stand	32"	30.2 x 20.9 x 9.4 inches_with stand 30.2 x 18.4 x 1.2 inches_without stand
	37"	33.9 x 22.4 x 7.2 inches_with stand 33.9 x 20.4 x 1.8 inches_without stand	37"	35.1 x 23.7 x 10.0 inches_with stand 35.1 x 21.2 x 1.2 inches_without stand
	40"	36.5 x 23.8 x 7.2 inches_with stand 36.5 x 21.8 x 1.8 inches_without stand	40"	37.6 x 25.1 x 10.2 inches_with stand 37.6 x 22.6 x 1.2 inches_without stand
	46"	41.8 x 26.9 x 9.0 inches_with stand 41.8 x 24.8 x 1.8 inches_without stand	46"	43.0 x 28.1 x 10.8 inches_with stand 43.0 x 25.6 x 1.2 inches_without stand
	50"	44.9 x 28.6 x 9.0 inches_with stand 44.9 x 26.5 x 1.8 inches_without stand		



Model	UE5N(UE**ES55*** / 57*** / 58***) Slim LED		UD5R(UE**D5500R*) LED	
Weight	32"	15.6 lbs_with stand 14.3 lbs_without stand	32"	22.0 lbs_with stand 15.9 lbs_without stand
	37"	24.1 lbs_with stand 19.2 lbs_without stand	37"	27.6 lbs_with stand 20.3 lbs_without stand
	40"	27.2 lbs_with stand 22.8 lbs_without stand	40"	31.7 lbs_with stand 24.4 lbs_without stand
	46"	33.5 lbs_with stand 29.1 lbs_without stand	46"	38.1 lbs_with stand 30.3 lbs_without stand
	50"	36.8 lbs_with stand 32.2 lbs_without stand		
Contrast Ratio	MEGA		MEGA	
Picture Enhancer	HyperReal Engine (X10+)		HyperReal Engine (X6)	
Equalizer	5 Band		5 Band	
Auto Volume Control	○		○	
Surround Sound	Dolby Digital Plus / Dolby Pulse		Dolby Digital plus	
Speaker Output	10 W x 10 W		10 W x 10 W	
PIP	○ (originally, included function)		○	
Function	Jog Function		Touch Function	
Antenna	DTV1 (Cable/Air), DTV2 (Satellite)		DTV1 (Cable/Air), DTV2 (Satellite)	

2. Product specifications

Model	UE5M(UE**EH53***) Direct LED		UD5R(UE**D5500R*) LED	
Design				
Display Type	LED TV 2D		LED TV 2D	
Built-in Tuner	○		○	
Resolution	1920 x 1080		1920 x 1080	
LCD Panel	TFT LCD Panel 60 Hz		TFT LCD Panel 60 Hz	
Picture ratio	16 : 9		16 : 9	
Power Consumption	32"	67 W / 69 W (Under 0.3W, Standby)	32"	68 W (Under 0.3W, Standby)
	37"	93 W (Under 0.3W, Standby)	37"	90 W (Under 0.3W, Standby)
	40"	87 W / 89 W (Under 0.3W, Standby)	40"	103 W (Under 0.3W, Standby)
	46"	96 W / 99 W (Under 0.3W, Standby)	46"	134 W (Under 0.3W, Standby)
	50"	116 W (Under 0.3W, Standby)		
Brightness	32"	320 cd / m ²	32"	286 cd / m ²
	37"	297 cd / m ²	37"	324 cd / m ²
	40"	286 cd / m ²	40"	318 cd / m ²
	46"	313 cd / m ²	46"	383 cd / m ²
	50"	368 cd / m ²		
Dimensions (W x H x D)	32"	29.1 x 19.6 x 7.5 inches_with stand 29.1 x 17.5 x 3.7 inches_without stand	32"	30.2 x 20.9 x 9.4 inches_with stand 30.2 x 18.4 x 1.2 inches_without stand
	37"	34.1 x 22.7 x 9.0 inches_with stand 34.1 x 20.4 x 3.7 inches_without stand	37"	35.1 x 23.7 x 10.0 inches_with stand 35.1 x 21.2 x 1.2 inches_without stand
	40"	36.5 x 23.9 x 9.0 inches_with stand 36.5 x 20.1 x 3.7 inches_without stand	40"	37.6 x 25.1 x 10.2 inches_with stand 37.6 x 22.6 x 1.2 inches_without stand
	46"	41.7 x 26.8 x 9.0 inches_with stand 41.7 x 24.6 x 3.7 inches_without stand	46"	43.0 x 28.1 x 10.8 inches_with stand 43.0 x 25.6 x 1.2 inches_without stand
	50"	44.8 x 28.5 x 9.0 inches_with stand 44.8 x 26.4 x 3.7 inches_without stand		
Weight	32"	14.6 lbs_with stand 13.0 lbs_without stand	32"	22.0 lbs_with stand 15.9 lbs_without stand
	37"	22.5 lbs_with stand 17.6 lbs_without stand	37"	27.6 lbs_with stand 20.3 lbs_without stand
	40"	24.3 lbs_with stand 19.8 lbs_without stand	40"	31.7 lbs_with stand 24.4 lbs_without stand
	46"	32.0 lbs_with stand 27.6 lbs_without stand	46"	38.1 lbs_with stand 30.3 lbs_without stand
	50"	40.3 lbs_with stand 34.6 lbs_without stand		
Contrast Ratio	MEGA		MEGA	



Model	UE5M(UE**EH53***) Direct LED	UD5R(UE**D5500R*) LED
Picture Enhancer	HyperReal Engine (X10+)	HyperReal Engine (X6)
Equalizer	5 Band	5 Band
Auto Volume Control	○	○
Surround Sound	Dolby Digital plus / Dolby Pulse	Dolby Digital plus
Speaker Output	10 W x 10 W	10 W x 10 W
PIP	○ (originally, included function)	○
Function	Jog Function	Touch Function
Antenna	DTV1 (Cable/Air)	DTV1 (Cable/Air), DTV2 (Satellite)



2. Product specifications

Model	UE**EH5450W Direct LED		UD5R(UE**D5500R*) LED	
Design				
Display Type	LED TV 2D		LED TV 2D	
Built-in Tuner	○		○	
Resolution	1920 x 1080		1920 x 1080	
LCD Panel	TFT LCD Panel 60 Hz		TFT LCD Panel 60 Hz	
Picture ratio	16 : 9		16 : 9	
Power Consumption	32"	67 W / 69 W (Under 0.3W, Standby)	32"	68 W (Under 0.3W, Standby)
	40"	87 W / 89 W (Under 0.3W, Standby)	40"	103 W (Under 0.3W, Standby)
	46"	96 W / 99 W (Under 0.3W, Standby)	46"	134 W (Under 0.3W, Standby)
Brightness	32"	320 cd / m ²	32"	286 cd / m ²
	40"	286 cd / m ²	40"	318 cd / m ²
	46"	313 cd / m ²	46"	383 cd / m ²
Dimensions (W x H x D)	32"	29.1 x 19.6 x 7.5 inches_with stand 29.1 x 17.5 x 3.7 inches_without stand	32"	30.2 x 20.9 x 9.4 inches_with stand 30.2 x 18.4 x 1.2 inches_without stand
	40"	36.5 x 23.9 x 9.0 inches_with stand 36.5 x 20.1 x 3.7 inches_without stand	40"	37.6 x 25.1 x 10.2 inches_with stand 37.6 x 22.6 x 1.2 inches_without stand
	46"	41.7 x 26.8 x 9.0 inches_with stand 41.7 x 24.6 x 3.7 inches_without stand	46"	43.0 x 28.1 x 10.8 inches_with stand 43.0 x 25.6 x 1.2 inches_without stand
Weight	32"	14.6 lbs_with stand 13.0 lbs_without stand	32"	22.0 lbs_with stand 15.9 lbs_without stand
	40"	24.3 lbs_with stand 19.8 lbs_without stand	40"	31.7 lbs_with stand 24.4 lbs_without stand
	46"	32.0 lbs_with stand 27.6 lbs_without stand	46"	38.1 lbs_with stand 30.3 lbs_without stand
Contrast Ratio	MEGA		MEGA	
Picture Enhancer	HyperReal Engine (X10+)		HyperReal Engine (X6)	
Equalizer	5 Band		5 Band	
Auto Volume Control	○		○	
Surround Sound	Dolby Digital plus / Dolby Pulse		Dolby Digital plus	

Model	UE**EH5450W Direct LED	UD5R(UE**D5500R*) LED
Speaker Output	10 W x 10 W	10 W x 10 W
PIP	○ (originally, included function)	○
Function	Jog Function	Touch Function
Antenna	DTV1 (Cable/Air)	DTV1 (Cable/Air), DTV2 (Satellite)

2. Product specifications

Model	UE4K(UE26EH45***) Direct LED		UD5P(UE27D50***) LED	
Design				
Display Type	LED TV 2D		LED TV 2D	
Built-in Tuner	○		○	
Resolution	1366 x 768		1920 x 1080	
LCD Panel	TFT LCD Panel 60 Hz		TFT LCD Panel 60 Hz	
Screen Size	26"		27"	
Picture ratio	16 : 9		16 : 9	
Power Consumption	26"	40 W (Under 0.3W, Standby)	27"	65 W (Under 0.3W, Standby)
Brightness	26"	257 cd / m ²	27"	288 cd / m ²
Dimensions (W x H x D)	26"	24.9 x 17.5 x 7.1 inches_with stand 24.9 x 15.5 x 3.8 inches_without stand 24.9 x 17.7 x 6.9 inches_with stand (E4510)	27"	23.7 x 17.8 x 6.9 inches_with stand 23.7 x 15.5 x 1.4 inches_without stand
Weight	26"	10.8 lbs_with stand 9.7 lbs_without stand 11.2 lbs_with stand (E4510)	27"	16.7 lbs_with stand 12.9 lbs_without stand
Contrast Ratio	MEGA		MEGA	
Picture Enhancer	HyperReal Engine (X10+)		HyperReal Engine (X5)	
Equalizer	5 Band		5 Band	
Auto Volume Control	○		○	
Surround Sound	Dolby Digital Plus / Dolby Pulse		Dolby Digital plus	
Function	Jog Function		Touch Function	
Speaker Output	5 W x 5 W		5 W x 5 W	
PIP	○ (originally, included function)		○ (originally, included function)	
Antena	DTV 1 (Cable/Air)		DTV 1 (Cable/Air)	

Model	UE5M(UE22EH54***) Slim LED_small		UD5P(UE22D50***) LED	
Design				
Display Type	LED TV 2D		LED TV 2D	
Built-in Tuner	○		○	
Resolution	1920 x 1080		1920 x 1080	
LCD Panel	TFT LCD Panel 60 Hz		TFT LCD Panel 60 Hz	
Screen Size	22"		22"	
Picture ratio	16 : 9		16 : 9	
Power Consumption	22"	30 W (Under 0.3W, Standby)	22"	36 W (Under 0.3W, Standby)
Brightness	22"	270 cd / m ²	22"	257 cd / m ²
Dimensions (W x H x D)	22"	20.6 x 14.9 x 6.7 inches_with stand 20.6 x 12.7 x 6.7 inches_without stand 20.6 x 14.8 x 2.0 inches_with stand (E5410)	22"	20.2 x 14.3 x 6.3 inches_with stand 20.2 x 12.4 x 2.0 inches_without stand
Weight	22"	8.2 lbs_with stand 7.5 lbs_without stand 8.4 lbs_with stand (E5410)	22"	7.7 lbs_with stand 7.3 lbs_without stand
Contrast Ratio	MEGA		MEGA	
Picture Enhancer	HyperReal Engine (X10+)		HyperReal Engine (X5)	
Equalizer	5 Band		5 Band	
Auto Volume Control	○		○	
Surround Sound	Dolby Digital Plus / Dolby Pulse		Dolby Digital plus	
Function	Jog Function		Touch Function	
Speaker Output	3 W x 3 W		3 W x 3 W	
PIP	○ (originally, included function)		○ (originally, included function)	
Antena	DTV 1 (Cable/Air)		DTV 1 (Cable/Air)	

2.2. Detail Factory Option



NOTE

If you replace the main board with new one, please change the factory option as well.
The options you must change are "Type".

■ **5500 (DVB - T / C)**

Model Name		UE32ES55***	UE37ES55***	UE40ES55***	UE46ES55***	UE50ES55***	
Panel	Vendor	CMI AUO	AUO	AUO SHARP AML	AUO AML	AUO	
	Code	BN07-01097A BN07-01114A	BN07-01144A	BN07-01117A BN95-00714A BN95-00603A	BN07-01121A BN95-00605A	BN07-01183A	
	Spec.	DE320BGM-C1 LE320BGA-B1	LE370BGA-C1	LE400BGA-B1 LE400BGS-V1 LTJ400HM09-V	LE460BGA-B1 LTJ460HN06-V	LE500BGA-B1	
SMPS	Vendor	SEM	SEM	SEM	SEM	SEM	
	Code	BN44-00501A	BN44-00527A	BN44-00502A	BN44-00502A	BN44-00503A	
	Spec.	PD32A1_CSM	PD37A1_CPN	PD46A1_CSM	PD46A1_CSM	PD55A1_CSM	
Byte	Item	Chassis Ass'y	BN91-08829X	BN91-08830R	BN91-08829Y	BN91-08829Z	BN91-09279E
0	Factory Reset	PBA Ass'y code	BN94-05561X	BN94-05562R	BN94-05561Y	BN94-05561Z	BN94-05841H
1	Type		32P6AF0E 32R6AF0E	37P6AF0E	40R6AF0E 40H6AF0E 40A6AF0E	46R6AF0E 46A6AF0E	50R6AF0E
2	Model		UE5500	UE5500	UE5500	UE5500	
3	SVC Model		5500	5500	5500	5500	
4	Local Set		EU_ITALY (Italy area models) EU_GER (Germany area models) EU_FRANCE (France area models) EU_BENELUX (Benelux area models) EU_SPAIN (Spain area models) CIS_RUSSIA (Russia area models)_Except 37" CIS_UKR (Ukraine area models)_Except 37",50" CIS_CA_MS (Azerbaijan area models)_Except 37" EU_TURKEY (Turkey area models)_Except 37" EU (other models)				
5	Tuner		SI_ATC2	SI_ATC2	SI_ATC2	SI_ATC2	SI_ATC2
6	Ch Table		NONE	NONE	NONE	NONE	NONE
7	Front Color		U-T-CL-M67	U-T-CL-M67	U-T-CL-M67	U-T-CL-M67	U-T-CL-M67

■ 5500 (DVB - T2 / C)

Model Name		UE32ES55***	UE37ES55***	UE40ES55***	UE46ES55***	UE50ES55***	
Panel	Vendor	CMI AUO	AUO	AUO SHARP AML	AUO AML	AUO	
	Code	BN07-01097A BN07-01114A	BN07-01144A	BN07-01117A BN95-00714A BN95-00603A	BN07-01121A BN95-00605A	BN07-01183A	
	Spec.	DE320BGM-C1 LE320BGA-B1	LE370BGA-C1	LE400BGA-B1 LE400BGS-V1 LTJ400HM09-V	LE460BGA-B1 LTJ460HN06-V	LE500BGA-B1	
SMPS	Vendor	SEM	SEM	SEM	SEM	SEM	
	Code	BN44-00501A	BN44-00527A	BN44-00502A	BN44-00502A	BN44-00503A	
	Spec.	PD32A1_ CSM	PD37A1_ CPN	PD46A1_ CSM	PD46A1_ CSM	PD55A1_ CSM	
Byte	Item	Chassis Ass'y	BN91-08830D	BN91-09279B	BN91-08830F	BN91-08830G	BN91-09279H
0	Factory Reset	PBA Ass'y code	BN94-05562D	BN94-05841B	BN94-05562F	BN94-05562G	BN94-05841L
1	Type		32P6AF0E 32R6AF0E	37P6AF0E	40R6AF0E 40H6AF0E 40A6AF0E	46R6AF0E 46A6AF0E	50R6AF0E
2	Model		UE5500	UE5500	UE5500	UE5500	UE5500
3	SVC Model		5500	5500	5500	5500	5500
4	Local Set		EU_UK (UK area models) NORDIC (Nordic area models) CIS_RUSSIA (Russia area models)_Except 37" CIS_UKR (Ukraine area models)_Except 37"				
5	Tuner		DVB_T2C	DVB_T2C	DVB_T2C	DVB_T2C	DVB_T2C
6	Ch Table		NONE	NONE	NONE	NONE	NONE
7	Front Color		U-T-CL-M67	U-T-CL-M67	U-T-CL-M67	U-T-CL-M67	U-T-CL-M67

■ 5700 (DVB - T / C / S2)

Model Name		UE32ES57***	UE37ES57***	UE40ES57***	UE46ES57***	UE50ES57***	
Panel	Vendor	CMI AUO	AUO	AUO SHARP AML	AUO AML	AUO	
	Code	BN07-01097A BN07-01114A	BN07-01144A	BN07-01117A BN95-00714A BN95-00603A	BN07-01121A BN95-00605A	BN07-01183A	
	Spec.	DE320BGM-C1 LE320BGA-B1	LE370BGA-C1	LE400BGA-B1 LE400BGS-V1 LTJ400HM09-V	LE460BGA-B1 LTJ460HN06-V	LE500BGA-B1	
SMPS	Vendor	SEM	SEM	SEM	SEM	SEM	
	Code	BN44-00501A	BN44-00527A	BN44-00502A	BN44-00502A	BN44-00503A	
	Spec.	PD32A1_CSM	PD37A1_CPN	PD46A1_CSM	PD46A1_CSM	PD55A1_CSM	
Byte	Item	Chassis Ass'y	BN91-08830H	BN91-08830J	BN91-08830K	BN91-08830P	BN91-09279J
0	Factory Reset	PBA Ass'y code	BN94-05562H	BN94-05562J	BN94-05562K	BN94-05562P	BN94-05841M
1	Type		32P6AF0E 32R6AF0E	37P6AF0E	40R6AF0E 40H6AF0E 40A6AF0E	46R6AF0E 46A6AF0E	50R6AF0E
2	Model		UE5700	UE5700	UE5700	UE5700	UE5700
3	SVC Model		5700	5700	5700	5700	5700
4	Local Set		EU_ITALY (Italy area models) EU_GER (Germany area models) EU_FRANCE (France area models) EU_BENELUX (Benelux area models) EU_SPAIN (Spain area models) EU_TURKEY (Turkey area models)_Except 37" NORDIC (Nordic area models) EU (other models)				
5	Tuner		DVB_TCS2	DVB_TCS2	DVB_TCS2	DVB_TCS2	DVB_TCS2
6	Ch Table		NONE	NONE	NONE	NONE	NONE
7	Front Color		U-T-CL-M67	U-T-CL-M67	U-T-CL-M67	U-T-CL-M67	U-T-CL-M67

■ 5800 (DVB - T / C / S2)

Model Name		UE32ES58***	UE40ES58***	UE46ES58***	
Panel	Vendor	CMI AUO	AUO SHARP AML	AUO AML	
	Code	BN07-01097A BN07-01114A	BN07-01117A BN95-00714A BN95-00603A	BN07-01121A BN95-00605A	
	Spec.	DE320BGM-C1 LE320BGA-B1	LE400BGA-B1 LE400BGS-V1 LTJ400HM09-V	LE460BGA-B1 LTJ460HN06-V	
SMPS	Vendor	SEM	SEM	SEM	
	Code	BN44-00501A	BN44-00502A	BN44-00502A	
	Spec.	PD32A1_CSM	PD46A1_CSM	PD46A1_CSM	
Byte	Item	Chassis Ass'y	BN91-09654M	BN91-09654N	BN91-09654P
0	Factory Reset	PBA Ass'y code	BN94-05851Q	BN94-05851R	BN94-05851S
1	Type		32P6AF0E 32R6AF0E	40R6AF0E 40H6AF0E 40A6AF0E	46R6AF0E 46A6AF0E
2	Model		UE5800	UE5800	UE5800
3	SVC Model		5800	5800	5800
4	Local Set		EU_ITALY (Italy area models) EU_GER (Germany area models) EU_SPAIN (Spain area models)		
5	Tuner		DVB_TCS2	DVB_TCS2	DVB_TCS2
6	Ch Table		NONE	NONE	NONE
7	Front Color		U-T-CL-M67	U-T-CL-M67	U-T-CL-M67

■ 5300 / 5450 (DVB - T / C)

Model Name		UE32EH53*** / UE32EH5450W	UE37EH53***	UE40EH53*** / UE40EH5450W	UE46EH53*** / UE46EH5450W	UE50EH53***	
Panel	Vendor	CMI AML	AUO	AML SHARP	AML	CMI	
	Code	BN07-01096A BN95-00586A	BN07-01194A	BN95-00587A BN95-00713A	BN95-00589A	BN07-01140A	
	Spec.	DE320BGM-C1 LTJ320HN07-V	DE370BGA-C1	LTJ400HM08-V DE400BGS-V1	LTJ460HN05-V	DE500BGM-C1	
SMPS	Vendor	HANSOE SEM	SEM	SEM	SEM	HANSOE	
	Code	BN44-00493B BN44-00493A	BN44-00498A	BN44-00498A	BN44-00498A	BN44-00499A	
	Spec.	PD32AVF_CHS PD32AVF_CSM	PD46AV1_CSM	PD46AV1_CSM	PD46AV1_CSM	PD55AV1_CHS	
Byte	Item	Chassis Ass'y	BN91-08828E	BN91-09234K	BN91-08828F	BN91-08828G	BN91-09234F
0	Factory Reset	PBA Ass'y code	BN94-05559E	BN94-05731K	BN94-05559F	BN94-05559G	BN94-05731F
1	Type		32P6AF0E 32A6AF0D	37P6AF0D	40R6AF0D 40H6AF0D	46R6AF0E	50P6AF0D
2	Model		UE5300	UE5300	UE5300	UE5300	UE5300
3	SVC Model		5300	5300	5300	5300	5300
4	Local Set		EU_ITALY (Italy area models) EU_GER (Germany area models)_Except 37" EU_FRANCE (France area models) EU_BENELUX (Benelux area models) EU_SPAIN (Spain area models) CIS_RUSSIA (Russia area models)_Except 37", 50" CIS_UKR (Ukraine area models)_Except 37", 50" CIS_CA_MS (Azerbaijan area models)_Except 37", 50" EU_TURKEY (Turkey area models)_Except 37" EU (other models)_Except 37"				
5	Tuner		SI_ATC2	SI_ATC2	SI_ATC2	SI_ATC2	SI_ATC2
6	Ch Table		NONE	NONE	NONE	NONE	NONE
7	Front Color		U-S-C-5K	U-S-C-5K	U-S-C-5K	U-S-C-5K	U-S-C-5K







■ 5300 / 5450 (DVB - T2 / C)

Model Name		UE32EH53*** / UE32EH5450W	UE37EH53***	UE40EH53*** / UE40EH5450W	UE46EH53*** / UE46EH5450W	UE50EH53**	
Panel	Vendor	CMI AML	AUO	AML SHARP	AML	CMI	
	Code	BN07-01096A BN95-00586A	BN07-01194A	BN95-00587A BN95-00713A	BN95-00589A	BN07-01140A	
	Spec.	DE320BGM-C1 LTJ320HN07-V	DE370BGA-C1	LTJ400HM08-V DE400BGS-V1	LTJ460HN05-V	DE500BGM-C1	
SMPS	Vendor	HANSOE SEM	SEM	SEM	SEM	HANSOE	
	Code	BN44-00493B BN44-00493A	BN44-00498A	BN44-00498A	BN44-00498A	BN44-00499A	
	Spec.	PD32AVF_CHS PD32AVF_CSM	PD46AV1_CSM	PD46AV1_CSM	PD46AV1_CSM	PD55AV1_CHS	
Byte	Item	Chassis Ass'y	BN91-09234C	BN91-09234L	BN91-09234D	BN91-09234E	BN91-09234G
0	Factory Reset	PBA Ass'y code	BN94-05731C	BN94-05731L	BN94-05731D	BN94-05731E	BN94-05731G
1	Type		32P6AF0E 32A6AF0D	37P6AF0D	40R6AF0D 40H6AF0D	46R6AF0E	50P6AF0D
2	Model		UE5300	UE5300	UE5300	UE5300	UE5300
3	SVC Model		5300	5300	5300	5300	5300
4	Local Set		EU_UK (UK area models) NORDIC (Nordic area models)_Except 37" CIS_RUSSIA (Russia area models)_Except 50" CIS_UKR (Ukraina area models)_Except 37", 50"				
5	Tuner		DVB_T2C	DVB_T2C	DVB_T2C	DVB_T2C	DVB_T2C
6	Ch Table		NONE	NONE	NONE	NONE	NONE
7	Front Color		U-S-C-5K	U-S-C-5K	U-S-C-5K	U-S-C-5K	U-S-C-5K

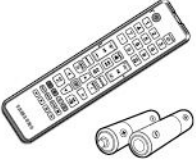
■ 4500 / 5400 (DVB- T / C)

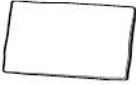
Model Name		UE26EH45***	UE22EH54***
Panel	Vendor	AUO	AML
	Code	BN07-01111A	BN07-01044A
	Spec.	DE260AGA-B	LTM215HT04-V
SMPS	Vendor	SEM	SEM
	Code	BN44-00491A	BN44-00504A
	Spec.	PD26AV0_CSM	PD23A0T_CPN
Byte	Item	Chassis Ass'y	
0	Factory Reset	PBA Ass'y code	
		BN91-09161Q	BN91-09155T
		BN94-05684Q	BN94-05679T
1	Type		
		26R6AF0D	22A6AF1E
2	Model		
		UE4500	UE5400
3	SVC Model		
		4500	5400
4	Local Set		
		EU_ITALY (Italy area models) EU_GER (Germany area models) EU_FRANCE (France area models) EU_BENELUX (Benelux area models) EU_SPAIN (Spain area models) EU_UK (UK area models) NORDIC (Nordic area models) EU (other models)	EU_ITALY (Italy area models) EU_GER (Germany area models) EU_FRANCE (France area models) EU_BENELUX (Benelux area models) EU_SPAIN (Spain area models) EU_TURKEY (Turkey area models) EU_UK (UK area models) NORDIC (Nordic area models) EU (other models)
5	Tuner		
		SI_ATC2	SI_ATC2
6	Ch Table		
		NONE	NONE
7	Front Color		
		NONE	NONE

2.3. Accessories

Product	Description	Code. No	Remark
	Remote Control Batteries (AAA x 2)	AA59-00582A AA59-00585A(Italy_MHP)	Samsung Electronics Service center
	Power Cord	3903-000603 3903-000619(UK Only)	
	Warranty Card / Manual Users / Safety Guide Manual	BN68-00514K BN68-04055A BN68-03019A	
	Cleaning Cloth	BN63-01798B	
	Holder-Wire stand	BN61-05491A	E5500, E5700, E5800 E5300, E4500 Models Supplied
	Holder-Ring x 4	BN61-07295A	E5500, E5700, E5800 Models Supplied
	Samsung Wireless LAN Adapter	AK40-00051A	E5800 Models Supplied

3. Disassembly and Reassembly

This section of the service manual describes the disassembly and reassembly procedures for the LED TV.



This LED TV contains electrostatically sensitive devices. Use caution when handling these components.





3.1. Disassembly and Reassemble





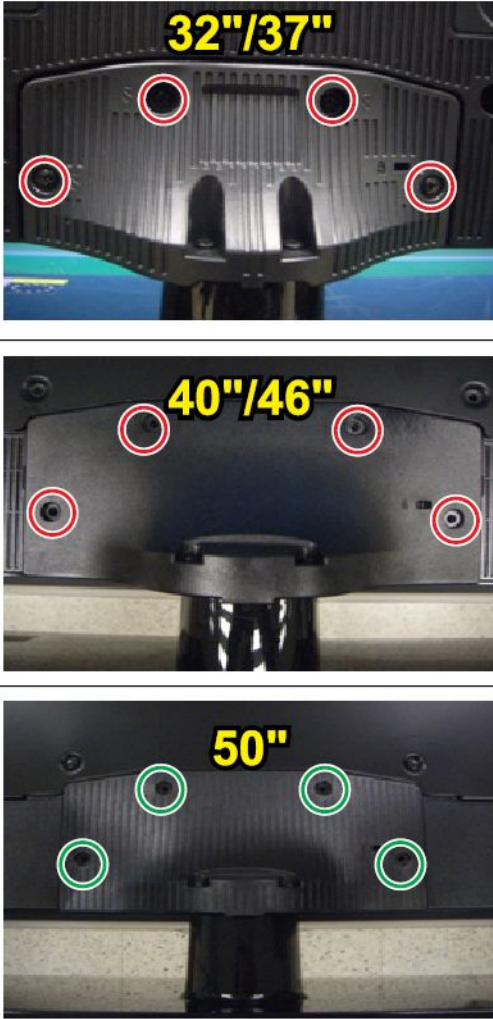



1. Disconnect the LED TV from the power source before disassembly.
2. Follow these directions carefully; never use metal instruments to pry apart the cabinet.
3. If there is no additional coment, it is same for all inches.

■ 55** / 57** / 58**

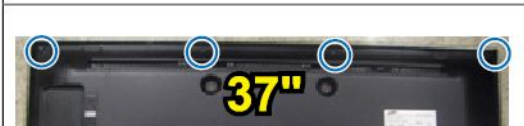

Description	Picture Description	Screws
<p>1 Place TV face down on cushioned table.</p>		



Description	Picture Description	Screws
<p>2 Remove 4 screws from the Stand.</p>	 <p>32"/37"</p> <p>40"/46"</p> <p>50"</p>	 <p>6003-001782</p>  <p>6003-001807</p>
<p>3 Remove Stand.</p>	 <p>32"/37"</p>	

Description	Picture Description	Screws
<p>4 Remove 1 screw of Middle Cover and 1 screw of Cover-Jack.</p> <p>Remove 9 screws of Rear Cover.</p>		<p>6003-001782</p> <p>6003-002755</p>

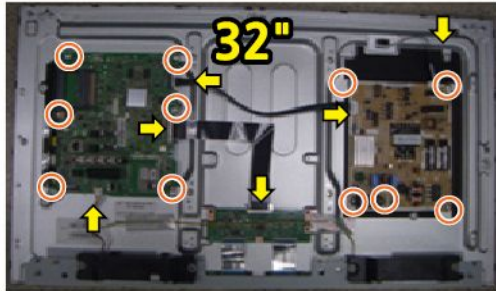

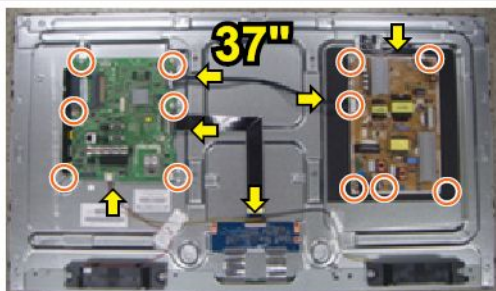
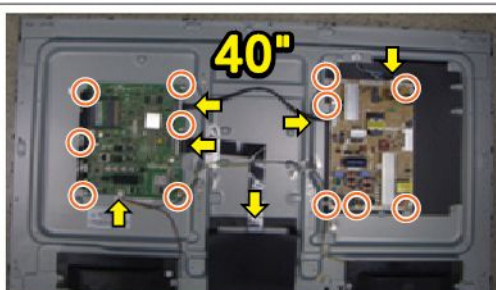
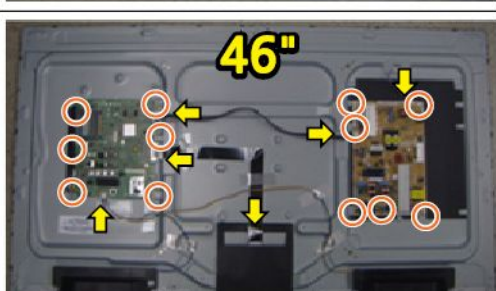
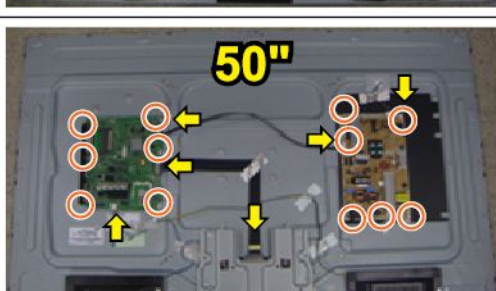
Description	Picture Description	Screws
<p>7 Remove the screws of Rear-Cover.</p> <ul style="list-style-type: none">• 32" : 11 EA		 6003-002755
<ul style="list-style-type: none">• 37" : 14 EA		
<ul style="list-style-type: none">• 40" : 14 EA		
<ul style="list-style-type: none">• 46" : 19 EA		
<ul style="list-style-type: none">• 50" : 15 EA		

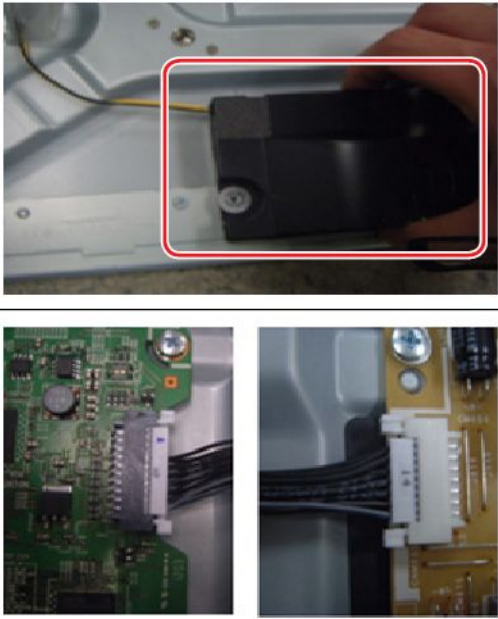
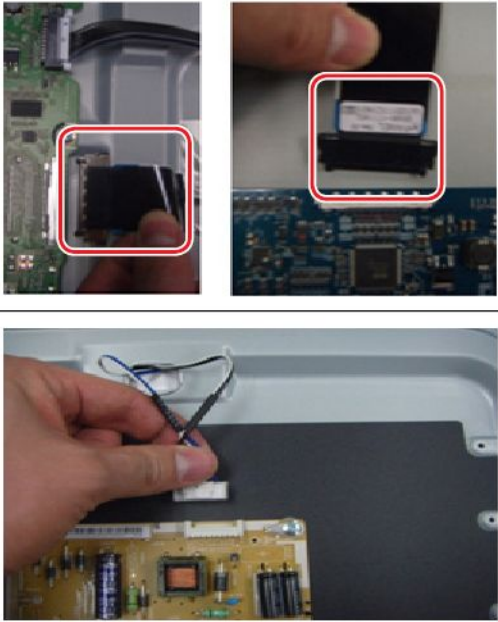
Description	Picture Description	Screws
<p>8 Remove the Middle Cover.</p>		

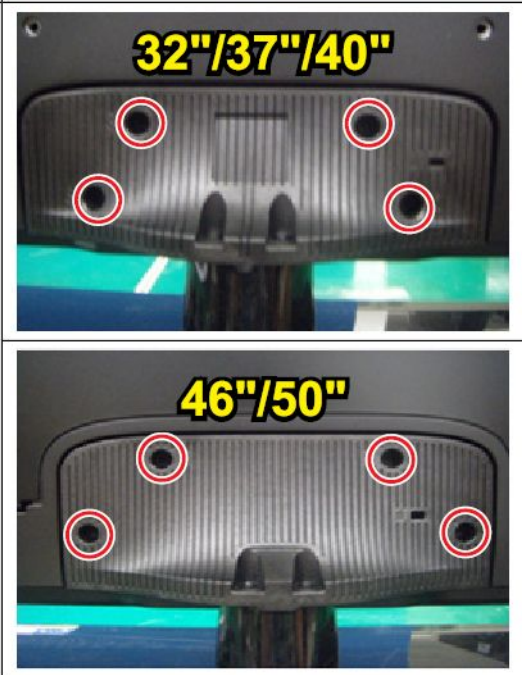

Description	Picture Description	Screws
<p>9 Remove the screws of main board and Power board.</p> <ul style="list-style-type: none"> • 32" : 11ea 		 6001-002756
<ul style="list-style-type: none"> • 37" : 12ea 		
<ul style="list-style-type: none"> • 40" : 12ea 		
<ul style="list-style-type: none"> • 46" : 12ea 		
<ul style="list-style-type: none"> • 50" : 12ea 		

Description	Picture Description	Screws
<p>10 Remove the Speakers and Power Cables.</p>		
<p>11 Remove the LVDS Cable and Panel Drive Cable.</p>		
<p>12 Completed disassembly.</p>		



■ 53** / 5450

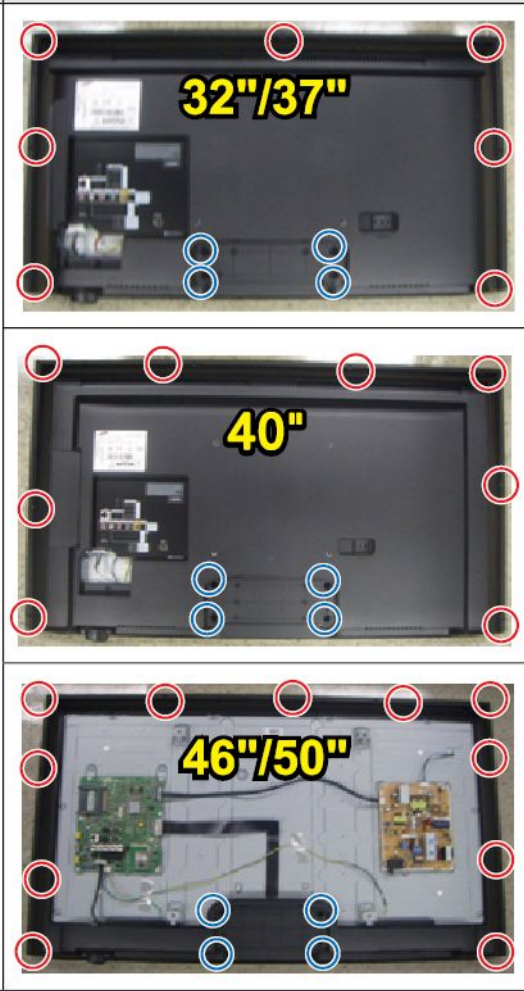

Description	Picture Description	Screws
<p>1 Place TV face down on cushioned table.</p>		
<p>2 Remove 4 screws from the Stand.</p>		 6003-001782

Description	Picture Description	Screws
<p>3 Remove Stand.</p>		
<p>4 Remove 1 screw of Middle Cover and 1 screw of Cover-Jack.</p> <p>Remove 11 screws of Rear-Cover.</p>		<p>6003-001782</p> <p>6003-002755</p>

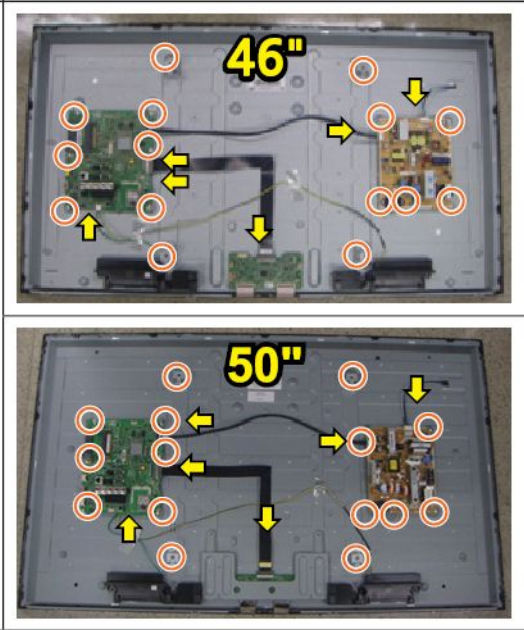
Description	Picture Description	Screws
<p>7 Remove the screws of Middle Cover.</p> <ul style="list-style-type: none"> • 32" / 37" : 11 EA • 40" : 12 EA • 46" / 50" : 15 EA 		 <p>6003-001782</p>  <p>6003-002755</p>

Description	Picture Description	Screws
<p>8 Remove the Rear-Cover.</p>		
<p>9 Remove the 15 screws of Main Board, Power Board, Bracket-Wall.</p>		 <p>6001-002756</p>

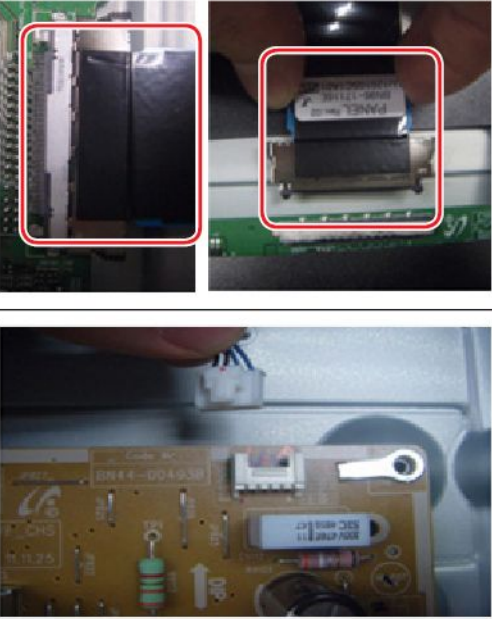
Description	Picture Description	Screws
		
<p>10 Remove the Speakers and Power Cables.</p>	 	

Description	Picture Description	Screws
<p>11 Remove the LVDS Cable and Panel Drive Cable.</p>		
<p>12 Completed disassembly.</p>		





NOTE

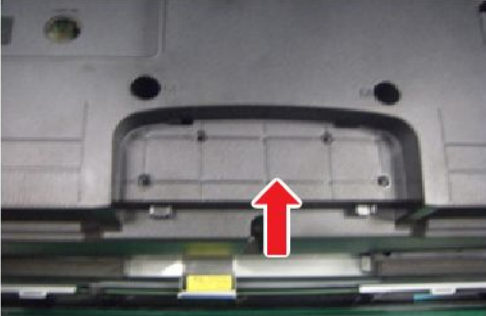
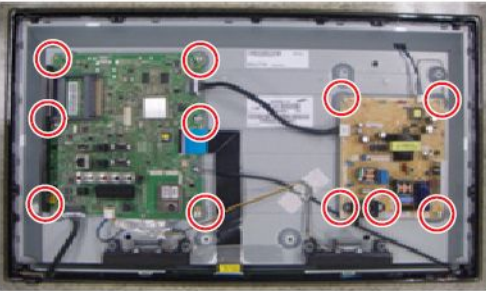

Reassembly procedures are in the reverse order of disassembly procedures.

■ 45**

Description	Picture Description	Screws
1 Place TV face down on cushioned table.		
2 Remove 4 screws from the Stand.		 6003-001782
3 Remove Stand.		
4 Remove 11 screw of Cover-Jack.		 6003-001782  6003-002755

Description	Picture Description	Screws
<p>5 Remove the Middle Cover.</p>		
<p>6 Remove 11 screws of Main board, Power board.</p>		 6001-002756
<p>7 Disconnect the function assy cable.</p>		

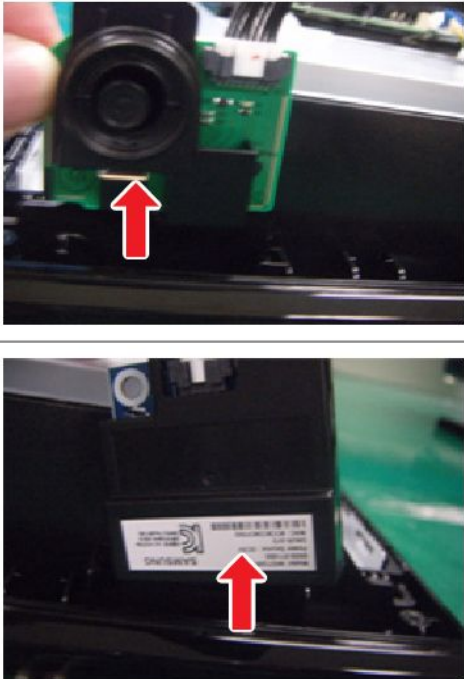





Description	Picture Description	Screws
<p>8 Remove the Speakers, Power Cable, Wifi Cable.</p>	  	
<p>9 • Remove the LVDS cable and Panel Drive Cable.</p>	 	



Description	Picture Description	Screws
<p>10 Remove the Wifi Module, Function Assy.</p>		
<p>11 Remove the LVDS Cable and Panel Drive Cable.</p>		
<p>12 Completed disassembly.</p>		



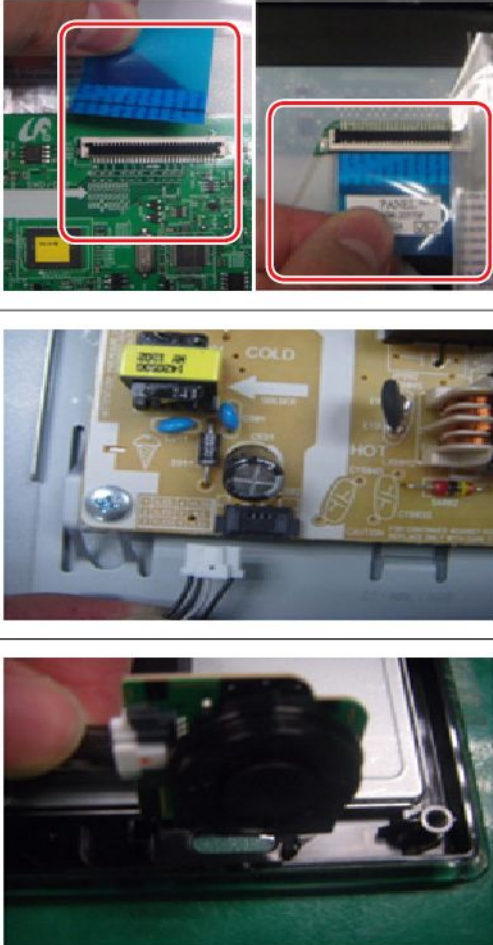
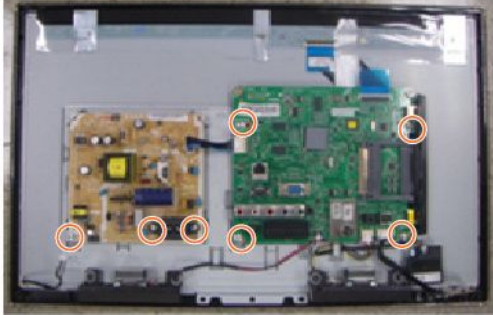

 **NOTE**

Reassembly procedures are in the reverse order of disassembly procedures.

■ 54**

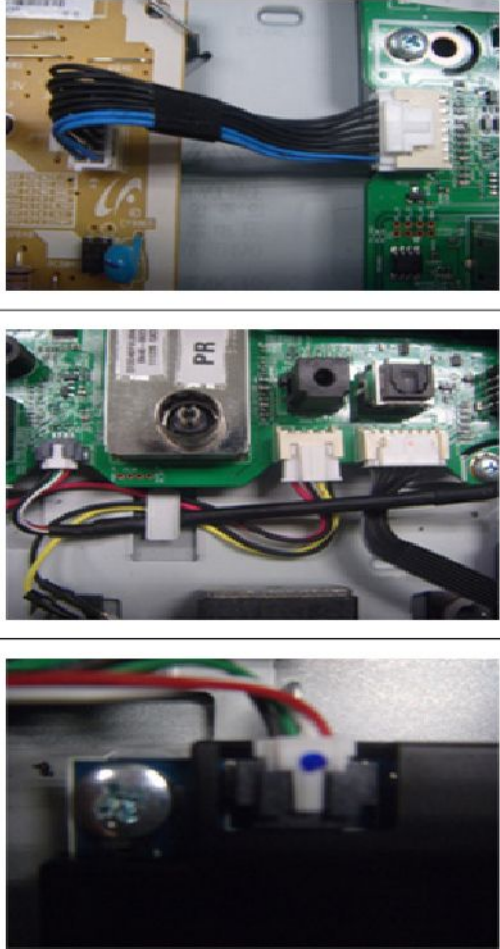
Description	Picture Description	Screws
<p>1 Place TV face down on cushioned table.</p>		
<p>2 Remove 3 screws from the stand bottom and Remove stand.</p>		 6003-001782
<p>3 Remove 5 screws of Rear-Cover.</p>		 6003-001782
<p>4 Remove the Middle Cover.</p>		

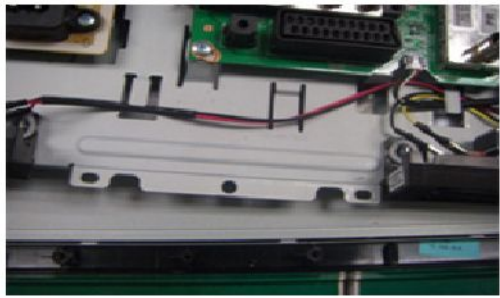
Description	Picture Description	Screws
<p>5 Disconnect the LVDS Cable, Panel Drive Cable, Function Assy.</p>		
<p>6 Remove 7 screws of Main Board and Power Board.</p>		 <p>6001-002756</p>

Description	Picture Description	Screws
<p>7 Disconnect Cables(Power,Speaker, Wifi).</p>		
<p> NOTE If you want to change the only panel, you don't need to separate Boards and Cables. (Except LVDS cable and Panel drive cable.)</p>		
<p>8 Lift up the Panel.</p>		

Description	Picture Description	Screws
<p>9 Completed disassembly</p>		

■ Screw Size

E55**/57**/58**

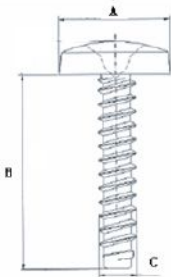
Code No.	COLOR	A (mm)	B (mm)	C (mm)	Q'ty	
6003-001782	BLACK	7.80~8.30	11.20~12.00	3.81~3.91	32" : 6EA 37" : 6EA 40" : 7EA 46" : 7EA 50" : 1EA	
6001-002755	BLACK	7.1~7.5	5.7~6.0	2.98~3.02	32" : 11EA 37" : 14EA 40" : 20EA 46" : 25EA 50" : 23EA	
6001-002756	WHITE	7.1~7.5	5.7~6.0	2.98~3.02	32" : 11EA 37" : 12EA 40" : 12EA 46" : 12EA 50" : 12EA	
6003-001807	BLACK	8.0~8.4	9.6~10.4	3.70~3.83	50" : 4EA	

E53**/E5450

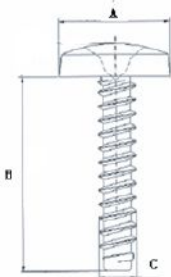
Code No.	COLOR	A (mm)	B (mm)	C (mm)	Q'ty	
6003-001782	BLACK	7.80~8.30	11.20~12.00	3.81~3.91	32" : 13EA 37" : 13EA 40" : 14EA 46" : 18EA 50" : 18EA	
6001-002755	BLACK	7.1~7.5	5.7~6.0	2.98~3.02	32" : 4EA 37" : 4EA 40" : 4EA 46" : 12EA 50" : 12EA	
6001-002756	WHITE	7.1~7.5	5.7~6.0	2.98~3.02	32" : 15EA 37" : 15EA 40" : 15EA 46" : 15EA 50" : 15EA	

E45**

Code No.	COLOR	A (mm)	B (mm)	C (mm)	Q'ty
6003-001782	BLACK	7.80~8.30	11.20~12.00	3.81~3.91	26" : 13EA
6001-002755	BLACK	7.1~7.5	5.7~6.0	2.98~3.02	26" : 2EA
6001-002756	WHITE	7.1~7.5	5.7~6.0	2.98~3.02	26" : 11EA

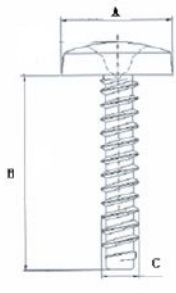

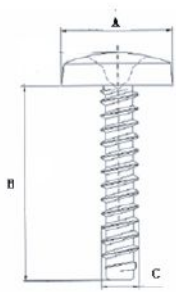

E54**

Code No.	COLOR	A (mm)	B (mm)	C (mm)	Q'ty
6003-001782	BLACK	7.80~8.30	11.20~12.00	3.81~3.91	22" : 8EA
6001-002755	BLACK	7.1~7.5	5.7~6.0	2.98~3.02	-
6001-002756	WHITE	7.1~7.5	5.7~6.0	2.98~3.02	22" : 7EA



3.2. Assy Board P-Jog Switch & Ir



■ Jog Function (Slim LED)_ UE55**/57**/58**

Description	Picture Description	Refer
<p>1 Check the 2 locking screws and remove the screws.</p>		
<p>2 Lift the Function assy.</p>		
<p>3 Disconnect the function cable.</p>		

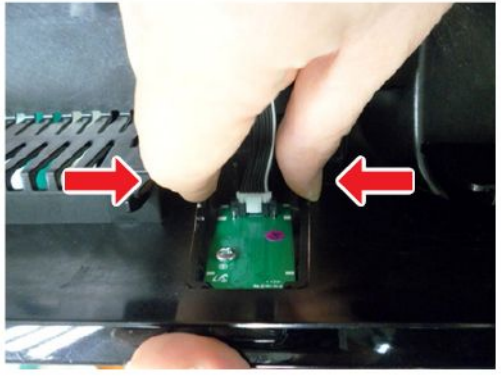
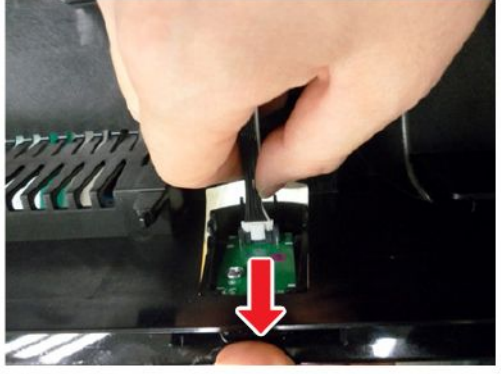
■ How to disassembly (UE53/5450)**





Description	Picture Description	Refer
1 Check the 2 Locking Holders.		
2 Press both holders.		
3 Remove the Function Assy.		



■ How to assembly

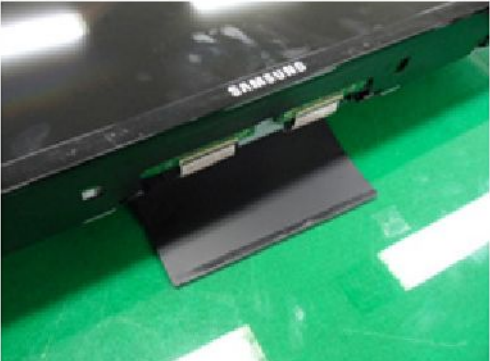

Description	Picture Description	Refer
<p>1 Check the locking hole.</p>		
<p>2 Combine the function assy to locking hole.</p>		
<p>3 Press the function assy to TV.</p>		

3.3. Disassembly(PTC)

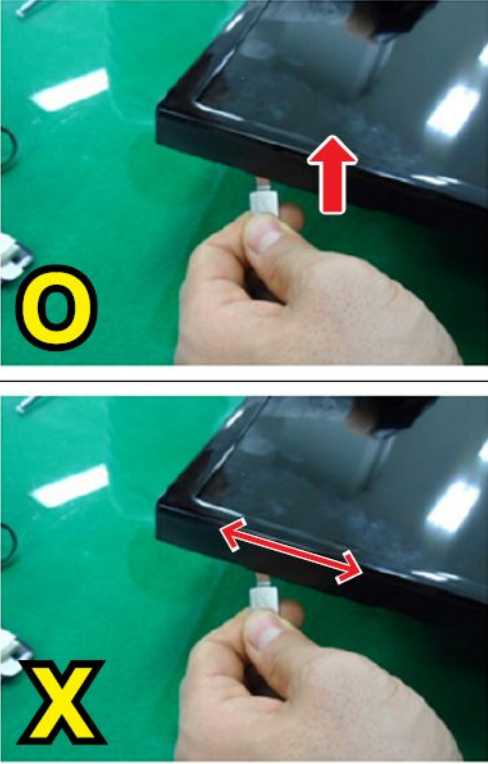

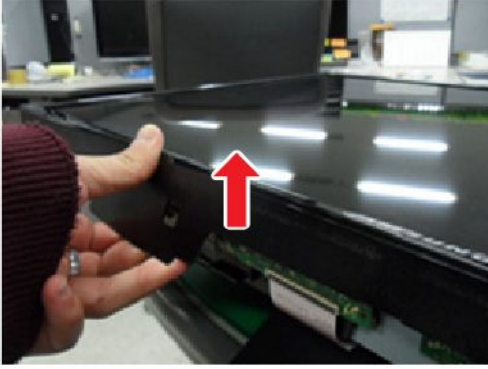
■ How to disassembly_Direct LED Only (UE45**, UE53**, UE5450 Models)







Description	Picture Description	Refer
<p>1 Place TV face up on cushioned table.</p>		
<p>2 Remove the T-CON Cover.</p>		
		
<p>3 First spread the PTC Upper</p>		

Description	Picture Description	Refer
<p>4 Spread the both sides of PTC upper (marked "▼") by use the tool.</p> <p>! CAUTION Do not scratch on both side by use tool. Gate Cof will be damaged.</p> 		
<p>5 Apart left and right sides of PTC.</p>		
<p>6 Raise up the PTC bottom.</p>		

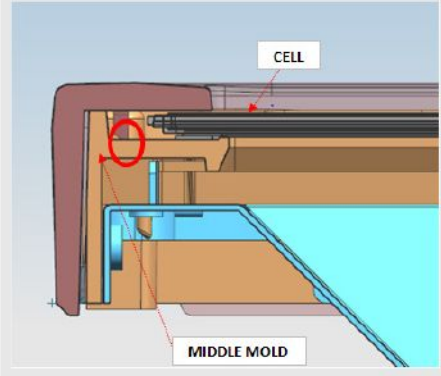
Description	Picture Description	Refer
7 Disassembly is complete.		
		

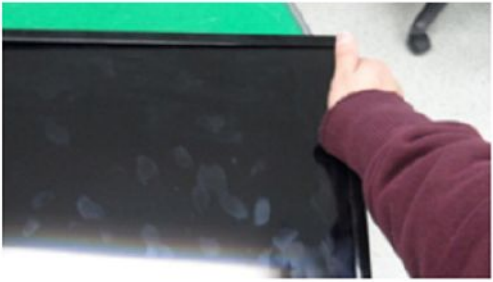
■ How to reassembly

Description	Picture Description	Refer
<p>1 Cover the PTC bottom.</p>		
		
<p>2 Combine the hook of left and right side.</p>		

Description	Picture Description	Refer
<p>3 Check to combine the top and bottom.</p> <p>! CAUTION Combine to stick the PTC Rib into the middle mold.</p> 	    	

Description	Picture Description	Refer
4 Assembly is complete.		

4. Troubleshooting

4.1. Troubleshooting

■ Previous Check

1. Check the various cable connections first.
 - Check to see if there is a burnt or damaged cable.
 - Check to see if there is a disconnected or loose cable connection.
 - Check to see if the cables are connected according to the connection diagram.
2. Check the power input to the Main Board.

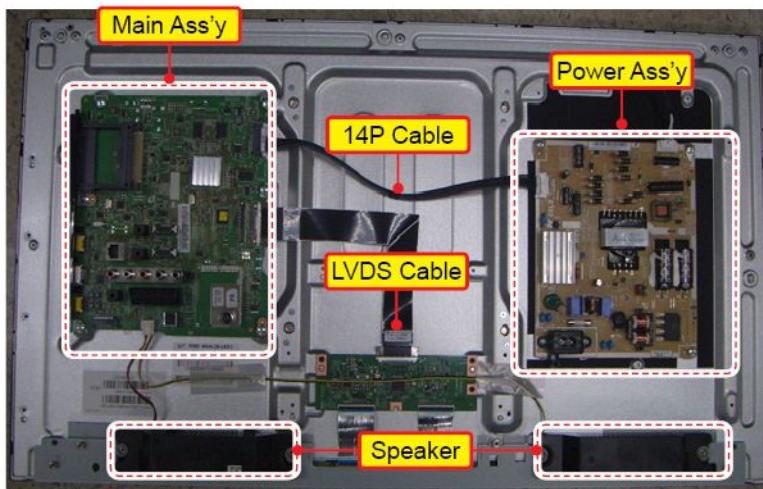

Main Board Assy (CN201)			
19	N.C	20	N.C
17	N.C	18	N.C
15	N.C	16	N.C
13	B13V	14	N.C
11	B13V	12	B13V
9	B12VS	10	B5.3V
7	B12VS	8	GND
5	GND	6	GND
3	B5.3V	4	A5.3V
1	B5.3V	2	A3.3V

Power Board Assy (CNM803)			
20	N.C	19	N.C
18	N.C	17	N.C
16	N.C	15	N.C
14	N.C	13	B13V
12	B13V	11	B13V
10	B5.3V	9	B12VS
8	GND	7	B12VS
6	GND	5	GND
4	A5.3V	3	B5.3V
2	A3.3V	1	B5.3V

* Pin Map (Series5 use the 14P / Series6 use the 20P)

3. Check the power in & output between IP & Main Board, Main Board & Panel, IP & Panel.

How to know it is from Main Board or T-Con when some problems happen

1. No Picture : Backlight is on, but there is no picture and LED indicator in front of TV is blinking.
 - Check the LVDS Cable connection. If still problems, change the T-Con Board and then Main Board step by step.
2. Picture distortion : Enter the service mode → Choose 'SVC' → Check the 'internal pattern.'

- Enter 'Service Mode.'

- If you do not have Factory remote control



- If you have Factory remote control



3. Choose 'SVC.'
4. Choose 'Test pattern.'
5. Select the each pattern and then check all pattern is ok or not.



Pattern Status is	Change the	Test Pattern is made by the MSTAR IC
OK	Main Board	We guess front of MSTAR IC has problem.
NG	Panel and T-Con Board	We guess back of MSATR IC has problem.

■ Location of Parts

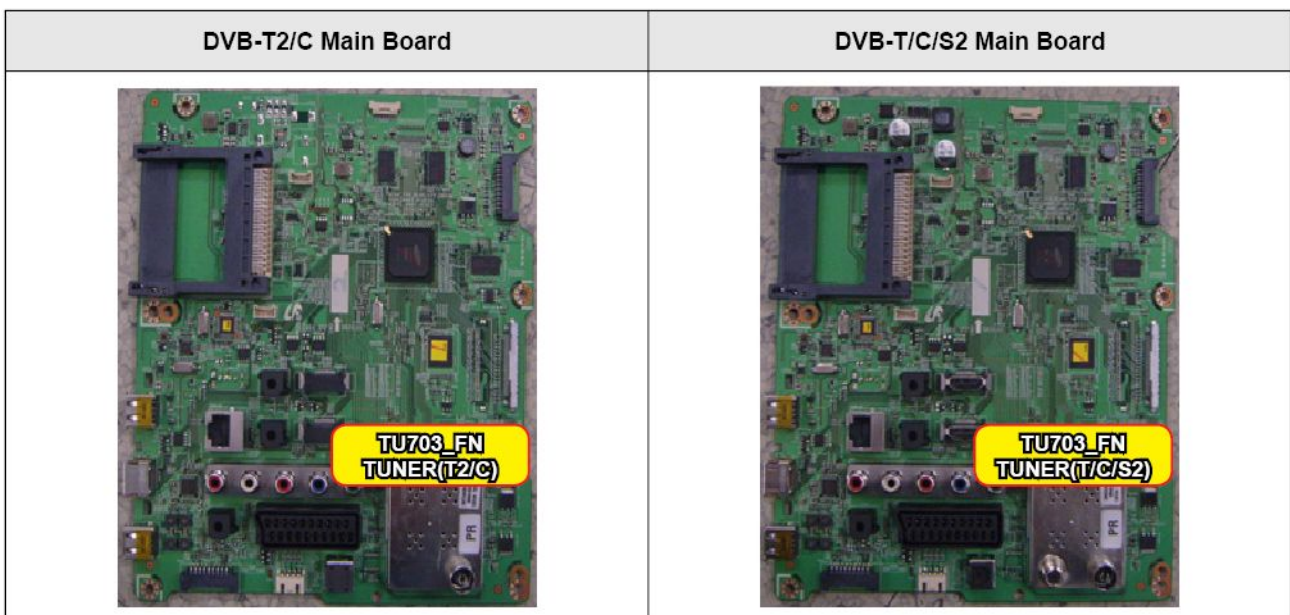
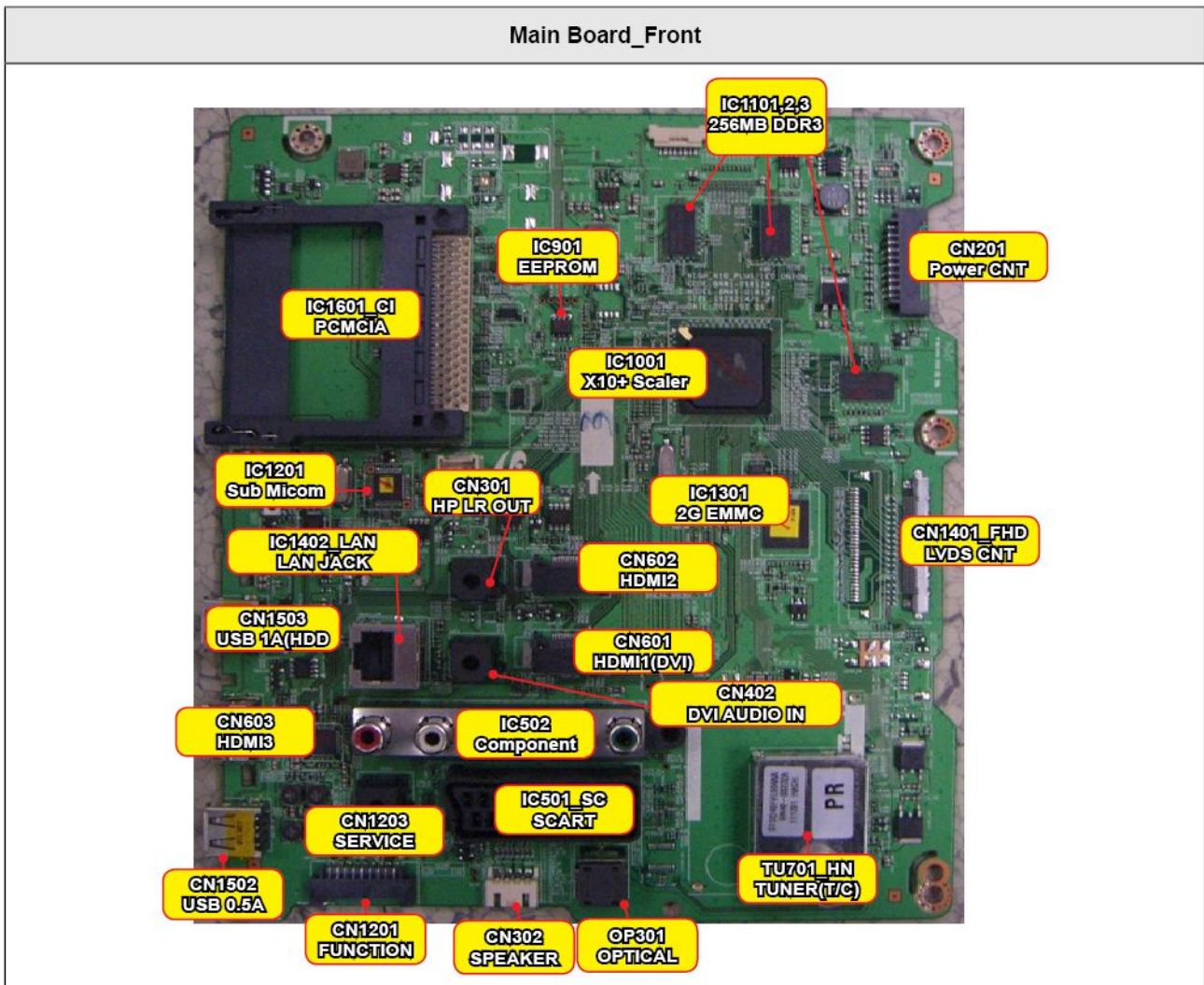

* SMPS and Power Board are used to same meaning

4.2. How to check fault symptom

■ NO Power

*Refer to the next page to check the location such a CN201 or IC1001 SVC Manual mentioned.

Symptom	<ul style="list-style-type: none"> The LEDs on The front panel do not work when connecting The power cord. The SMPS relay does not work when connecting The power cord. The units appears to be dead.
Major checkpoints	<p>The SMPS relay or the LEDs on the front panel does not work when connecting the power cord if the cables are improperly connected or the Main Board or SMPS is not functioning. In this case, check the following:</p> <ul style="list-style-type: none"> Check the internal cable connection status inside the unit. Check the fuses of each part. Check the output voltage of SMPS. Replace the Main Board.
Diagnostics	<pre> graph TD Q1[Power indicator LED is on?] -- No --> A1[Check a connetion power code.] Q1 -- Yes --> Q2[Check 'Stand-By A5.3V' 5.3V appear at BD207? 0V to 5.3V (CN201 #4)] Q2 -- No --> A2[Change the Power cable. Change SMPS.] Q2 -- Yes --> S1[Set On.] S1 -- Yes --> Q3[Check 'SW_POWER' more than 3.3V appear at CN201(#2) ? 0V to 3.3V↑ (CN201 #2)] Q3 -- No --> A3["Cause : Main IC(X10+) did not control the SW_Power. Measure : Change the Main Assy."] Q3 -- Yes --> Q4[Check 'Power input of Main Ass'y' ? DC B13V, B5.3V appear at CN201 #11,12,13(B13V) CN201 #1,3 (B5.3V)? 0V to 13V (CN201 #11,12,13)0V to 5.3V (CN201 #1,3)] Q4 -- No --> A4["Cause : There did not supply the power from SMPS. Measure : Change 20p/14p power cable and SMPS."] Q4 -- Yes --> Q5[Check 'Power IC output of Main Ass'y' ? L202 : B3.3V / L203 : B1.15V L201 : B5V / IC208 : 3.3V] Q5 -- No --> A5["Cause : There is problem at DCDC/ LDO. Measure : Change the Main Board."] Q5 -- Yes --> Q6[Check 'Power of LVDS (13V)' appear at TP-PANEL_VCC? 0V to 13V (TP-PANEL_VCC)] Q6 -- No --> A6["Cause : There is proble at FET(Q201) or Main IC(X9) did not control the SW_PVCC. Measure : Change the Main Board."] </pre>

	<p style="text-align: center;">Yes ↓</p> <div style="border: 1px solid black; padding: 5px; margin: 0 auto; width: fit-content;">Please, Contact tech support.</div>
Caution	Make sure to disconnect the power before working on the IP board.

■ Location of Parts

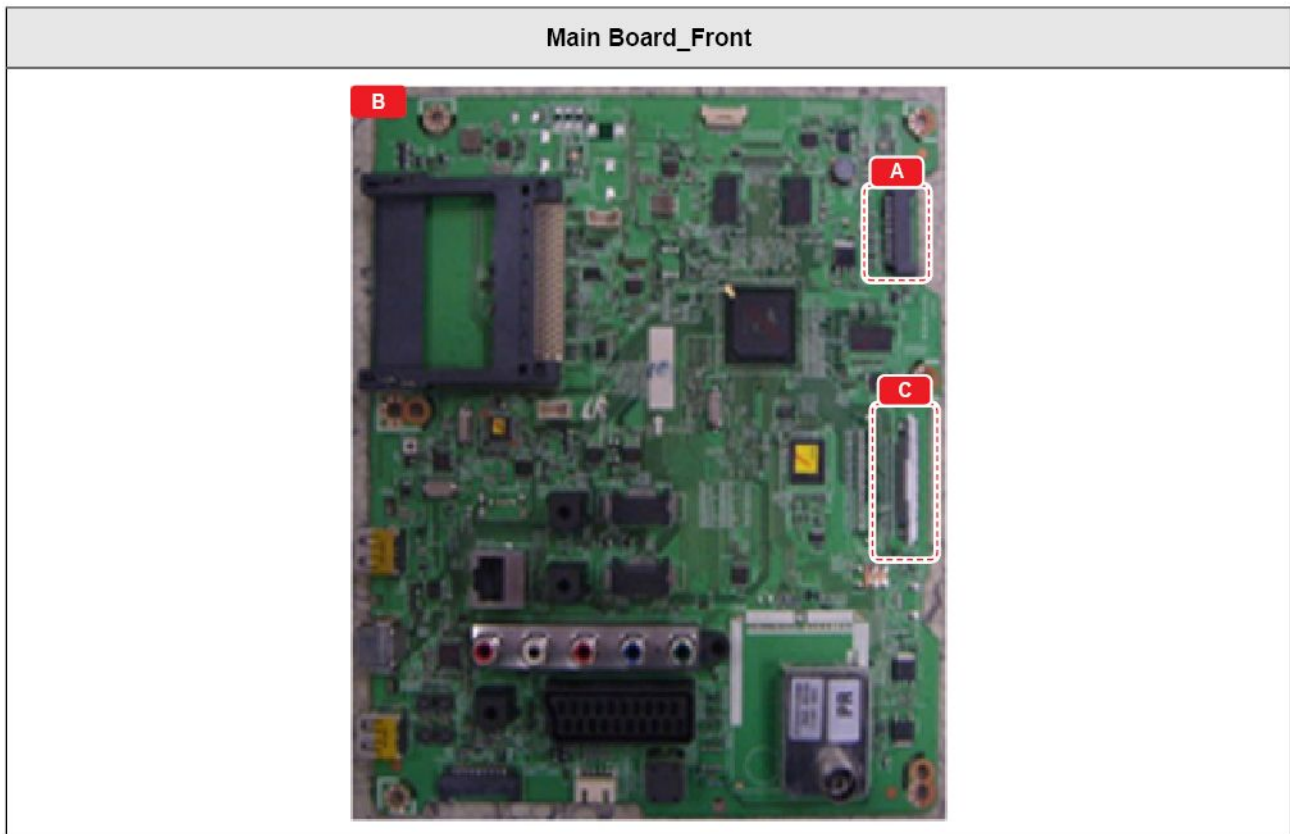

Detail			
A	<p>BD214 : B13V BD209</p> <p>BD206 : B12V BD201</p> <p>BD213 : B5.3V BD208</p> <p>BD207 : A5.3V</p>	C	<p>PANEL_VCC Pin #51</p>
B	<p>L201 : B5V</p> <p>L202 : B1.15V</p> <p>L203 : B3.3V</p> <p>BD211 : B1.5V</p>		

■ No Video (HDMI 1, 2, 3 - Digital Signal)

*Refer to the next page to check the location such a CN201 or IC1001 SVC Manual mentioned.

Symptom	<ul style="list-style-type: none"> Audio is normal but no picture is displayed on the screen.
Major checkpoints	<ul style="list-style-type: none"> Check the HDMI source. Check the HDMI switch. This may happen when the LVDS cable connecting the Main Board and the Panel is disconnected.
Diagnostics	<pre> graph TD Q1[Power indicator LED is off. Lamp(Backlight) on, no video ?] -- No --> A1[Check a set in the 'Stand-by mode'.] Q1 -- Yes --> Q2[Check the HDMI source and check the connection of HDMI cable ?] Q2 -- No --> A2[Input the HDMI signal properly.] Q2 -- Yes --> Q3[Check the signal at Input of Main board ?] Q3 -- No --> A3[Check CN601~3. Check HDMI cable. Change the Main Board.] Q3 -- Yes --> Q4[Check the LVDS clk signal at output of Main board.(TX) ODD_TXCLK- / ODD_TXCLK+ EVEN_TXCLK- / EVEN_TXCLK+] Q4 -- No --> A4[Check IC1001(X10+). Change the Main Board.] Q4 -- Yes --> Q5[Check the LVDS cable? Replace the T-con / LCD panel?] Q5 -- No --> A5[Please, Contact Tech support.] </pre>
Caution	Make sure to disconnect the power before working on the Power board.

■ Location of Parts

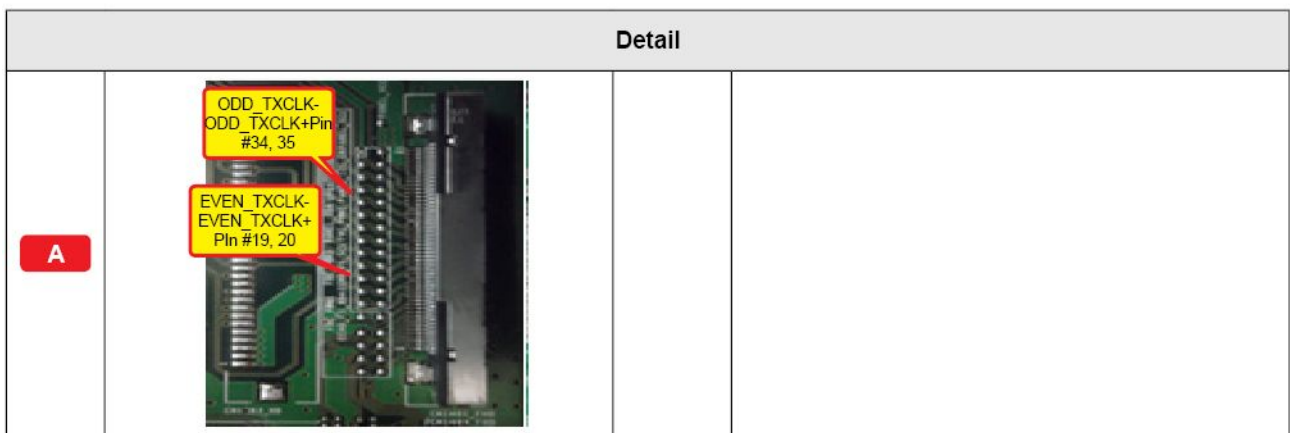
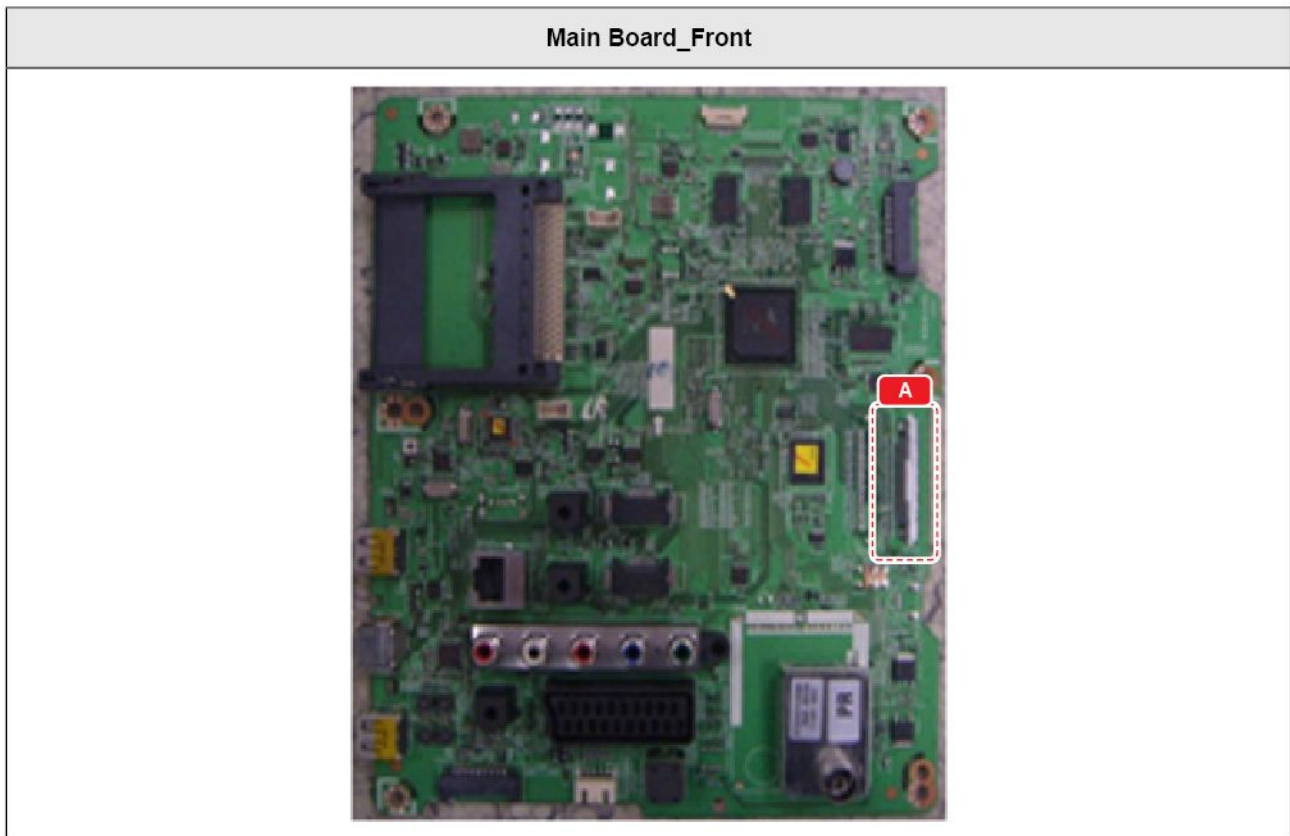

■ No Video (Tuner_CVBS)

*Refer to the next page to check the location such a CN201 or IC1001 SVC Manual mentioned.

Symptom	<ul style="list-style-type: none"> Audio is normal but no picture is displayed on the screen.
Major checkpoints	<ul style="list-style-type: none"> Check the Tuner CVBS source. Check the Tuner. This may happen when the LVDS cable connecting the Main Board and the Panel is disconnected.
Diagnostics	<pre> graph TD Q1[Power indicator LED is off. Lamp(Backlight) on, no video?] -- No --> A1[Check a set in the 'Stand-by mode'.] Q1 -- Yes --> Q2[Check the RF source and check the connection of RF cable?] Q2 -- No --> A2[Input the RF source properly.] Q2 -- Yes --> Q3[1 Check the Power of Tuner ? Pin #4 of Tuner : B3.3V_Tuner Pin #2 of Tuner : B1.8V_Tuner] Q3 -- No --> A3[Change the Main Board.] Q3 -- Yes --> Q4[2 Check the CVBS data out of IC1001 ? C807 : Tuner CVBS] Q4 -- No --> A4[Check IC1001(X10+). Change the Main Board.] Q4 -- Yes --> Q5[2 Check the LVDS clk signal at output of Main board.(TX) ODD_TXCLK- / ODD_TXCLK+ EVEN_TXCLK- / EVEN_TXCLK+] Q5 -- No --> A5[Check IC1001(X10+). Change the Main Board.] Q5 -- Yes --> Q6[Check the LVDS cable? Replace the T-con / LCD panel?] Q6 -- No --> A6[Please, Contact Tech support.] </pre>
Caution	Make sure to disconnect the power before working on the Power board.

■ Location of Parts

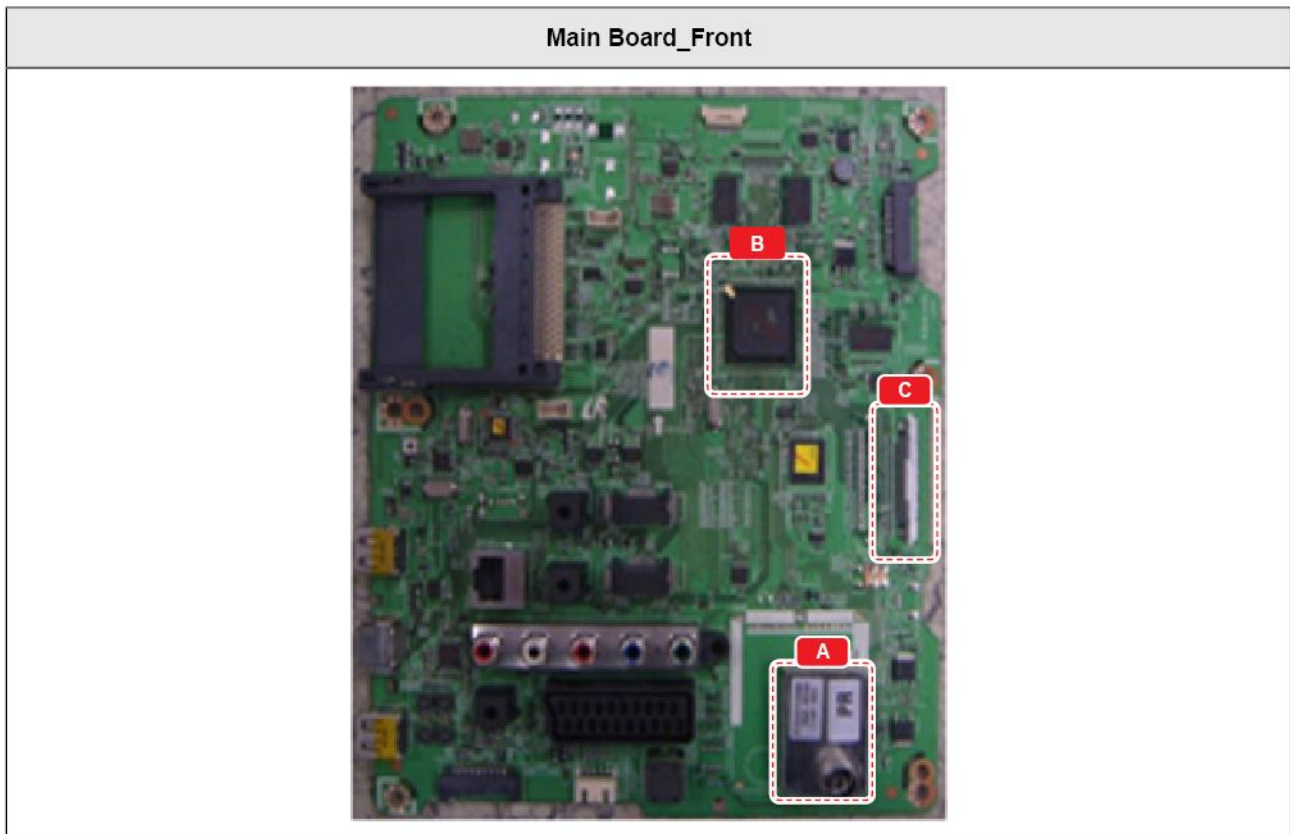

Detail

A	<p>Pin #10</p>	B	<p>C807</p>
C	<p>ODD_TXCLK- ODD_TXCLK+Pin #34, 35</p> <p>EVEN_TXCLK- EVEN_TXCLK+ Pin #19, 20</p>		

■ No Video (Tuner DTV)

*Refer to the next page to check the location such a CN201 or IC1001 SVC Manual mentioned.

Symptom	<ul style="list-style-type: none"> Audio is normal but no picture is displayed on the screen.
Major checkpoints	<ul style="list-style-type: none"> Check the DTV source. Check the Tuner. This may happen when the LVDS cable connecting the Main Board and the Panel is disconnected.
Diagnostics	<pre> graph TD Q1[Power indicator LED is off. Lamp(Backlight) on, no video ?] -- No --> A1[Check a set in the 'Stand-by mode'.] Q1 -- Yes --> Q2[Check the RF source and check the connection of RF cable ?] Q2 -- No --> A2[Input the RF source properly.] Q2 -- Yes --> Q3[1 Check the 'signal strength' in Self Diagnosis menu Strength is enough ?] Q3 -- No --> A3[Check the D-TV source.] Q3 -- Yes --> Q4[2 Check the Power of Tuner ? Pin #4 of Tuner : B3.3V_Tuner Pin #2 of Tuner : B1.8V_Tuner] Q4 -- No --> A4[Change the Main Board.] Q4 -- Yes --> Q5[2 Check the LVDS clk signal at output of Main board.(TX) ODD_TXCLK- / ODD_TXCLK+ EVEN_TXCLK- / EVEN_TXCLK+] Q5 -- No --> A5[Check IC1001(X10+). Change the Main Board.] Q5 -- Yes --> Q6[Check the LVDS cable? Replace the T-con / LCD panel?] Q6 -- No --> A6[Please, Contact Tech support.] </pre>
Caution	Make sure to disconnect the power before working on the Power board.

■ Location of Parts

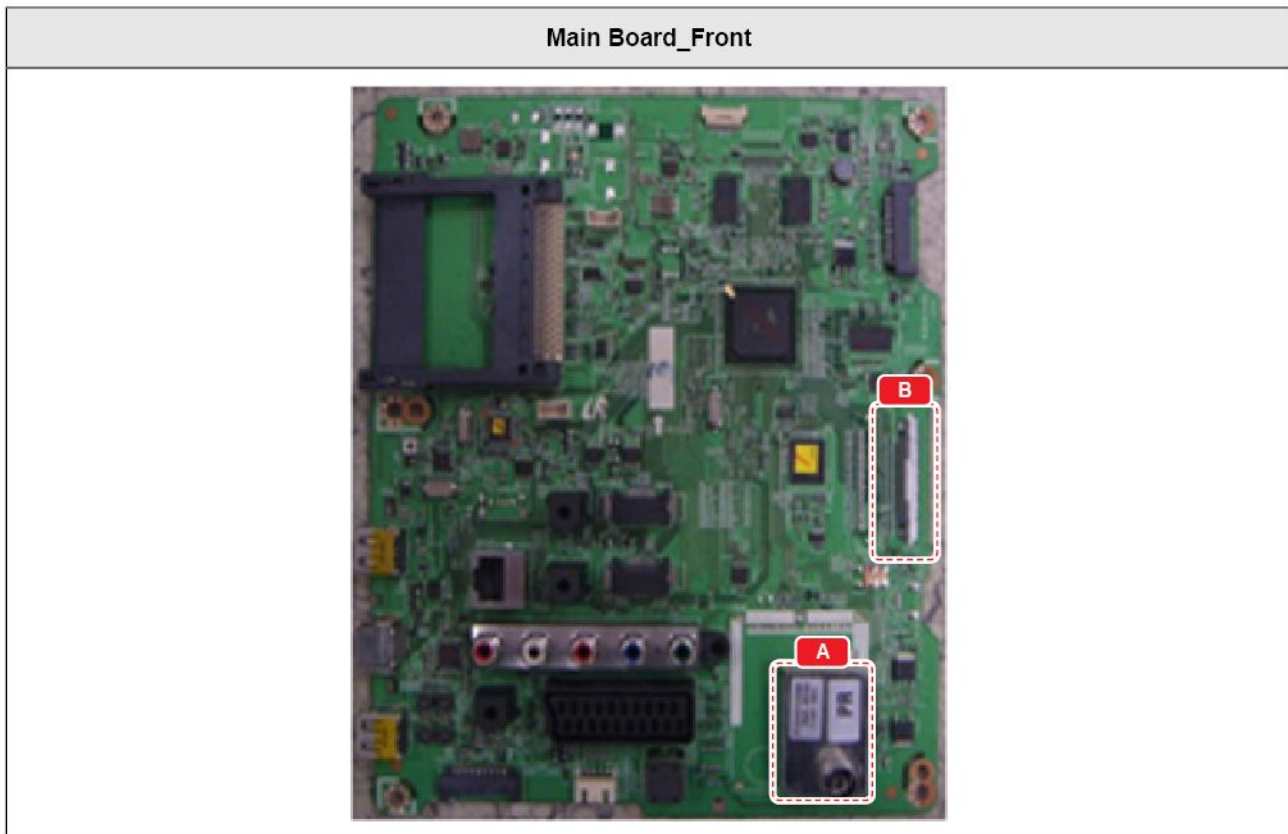

Detail			
A (Front)	<p>Pin #4</p> <p>Pin #2</p>	A (Back)	<p>Pin #4</p> <p>Pin #2</p>
B	<p>ODD_TXCLK- ODD_TXCLK+Pin #34, 35</p> <p>EVEN_TXCLK- EVEN_TXCLK+ Pin #19, 20</p>		

■ No Video (Video AV)

*Refer to the next page to check the location such a CN201 or IC1001 SVC Manual mentioned.

Symptom	<ul style="list-style-type: none"> Audio is normal but no picture is displayed on the screen.
Major checkpoints	<ul style="list-style-type: none"> Check the Video CVBS source. This may happen when the LVDS cable connecting the Main Board and the Panel is disconnected.
Diagnostics	<pre> graph TD Q1[Power indicator LED is off. Lamp(Backlight) on, no video ?] -- No --> A1[Check a set in the 'Stand-by mode'.] Q1 -- Yes --> Q2[Check the video source and check the connection of video cable?] Q2 -- No --> A2[Input the video source properly.] Q2 -- Yes --> Q3[Check the LVDS clk signal at output of Main board.(TX) ② ODD_TXCLK- / ODD_TXCLK+ EVEN_TXCLK- / EVEN_TXCLK+] Q3 -- No --> A3[Check IC1001(X10+). Change the Main Board.] Q3 -- Yes --> Q4[Check the LVDS cable? Replace the T-con / LCD panel?] Q4 -- No --> A4[Please, Contact Tech support.] </pre>
Caution	<p>Make sure to disconnect the power before working on the Power board.</p>

■ Location of Parts

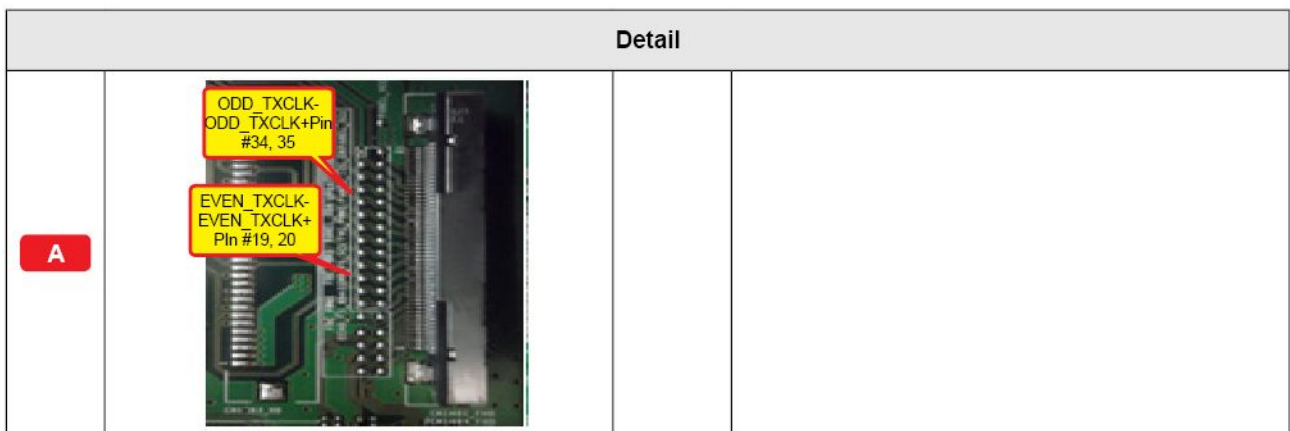
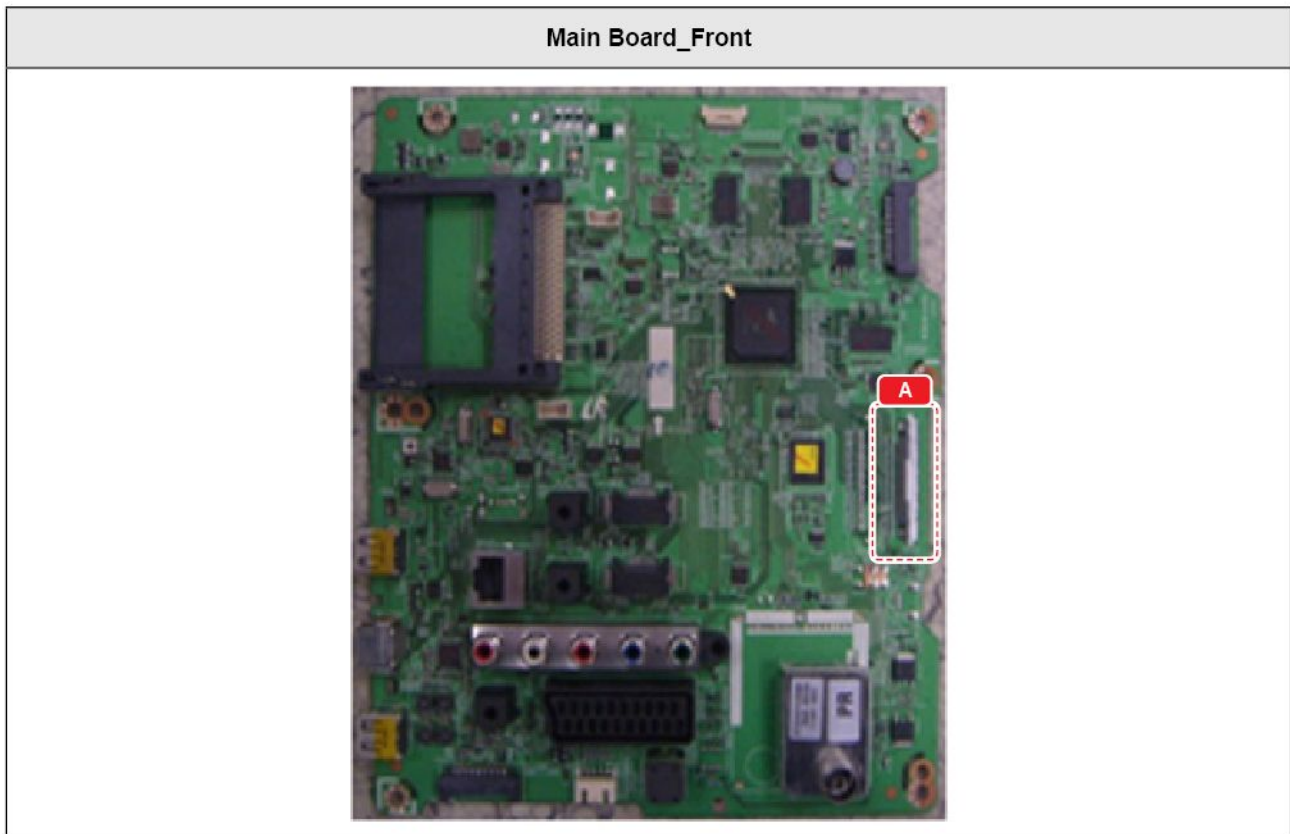

■ No Video (Component)

*Refer to the next page to check the location such a CN201 or IC1001 SVC Manual mentioned.

Symptom	<ul style="list-style-type: none"> Audio is normal but no picture is displayed on the screen.
Major checkpoints	<ul style="list-style-type: none"> Check the Component source. This may happen when the LVDS cable connecting the Main Board and the Panel is disconnected.
Diagnostics	<pre> graph TD Q1[Power indicator LED is off. Lamp(Backlight) on, no video ?] -- No --> A1[Check a set in the 'Stand-by mode'.] Q1 -- Yes --> Q2[Check the component source and check the connection of component cables(Y,Pb,Pr) ?] Q2 -- No --> A2[Input the component source properly.] Q2 -- Yes --> Q3[Does the component data appear at ? Comp1 Y : R530 Pb : R531 Pr : R532] Q3 -- No --> A3[Check CN502 or Component gender. Change the Main Board.] Q3 -- Yes --> Q4[Check the LVDS clk signal at output of Main board.(TX) ODD_TXCLK- / ODD_TXCLK+ EVEN_TXCLK- / EVEN_TXCLK+] Q4 -- No --> A4[Check IC1001(X10+). Change the Main Board.] Q4 -- Yes --> Q5[Check the LVDS cable? Replace the T-con / LCD panel?] Q5 -- No --> A5[Please, Contact Tech support.] </pre>
Caution	Make sure to disconnect the power before working on the Power board.

■ Location of Parts

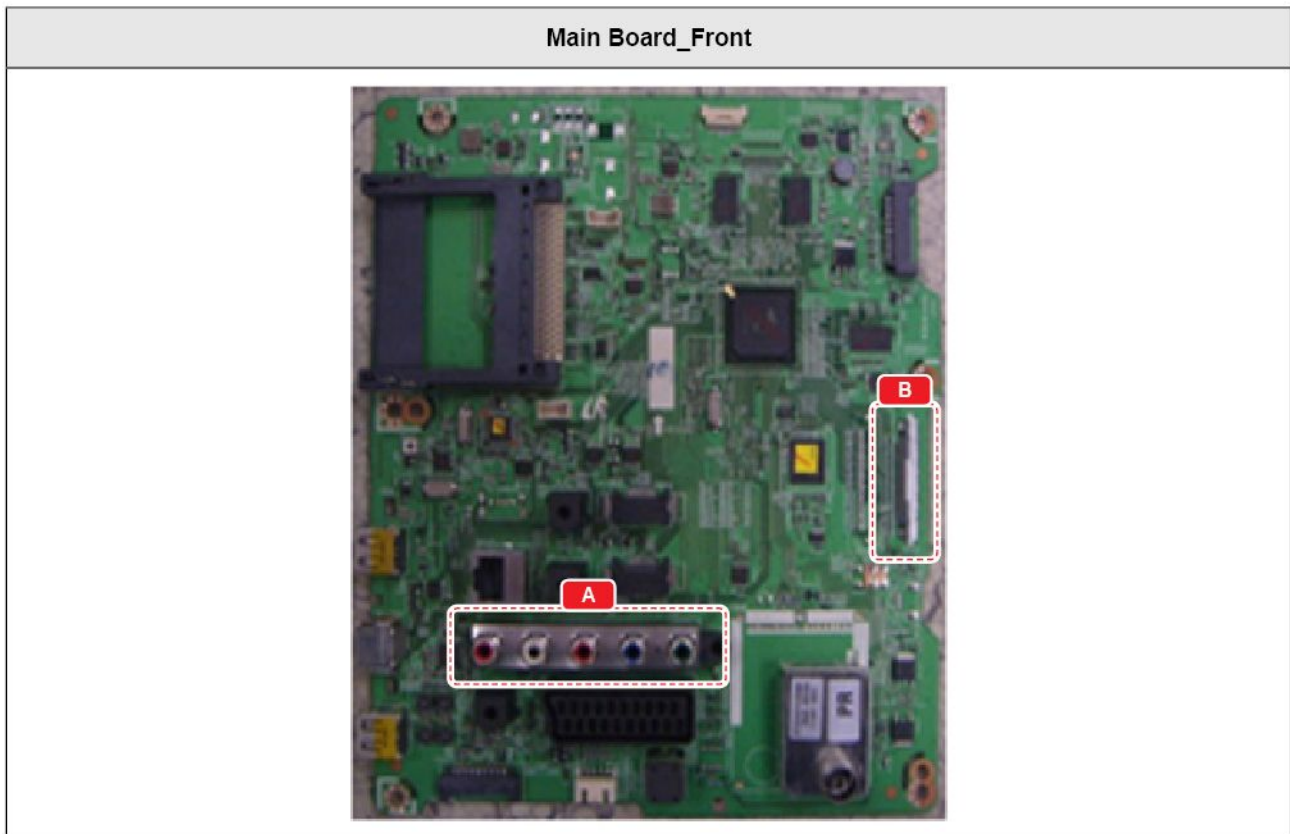

Detail

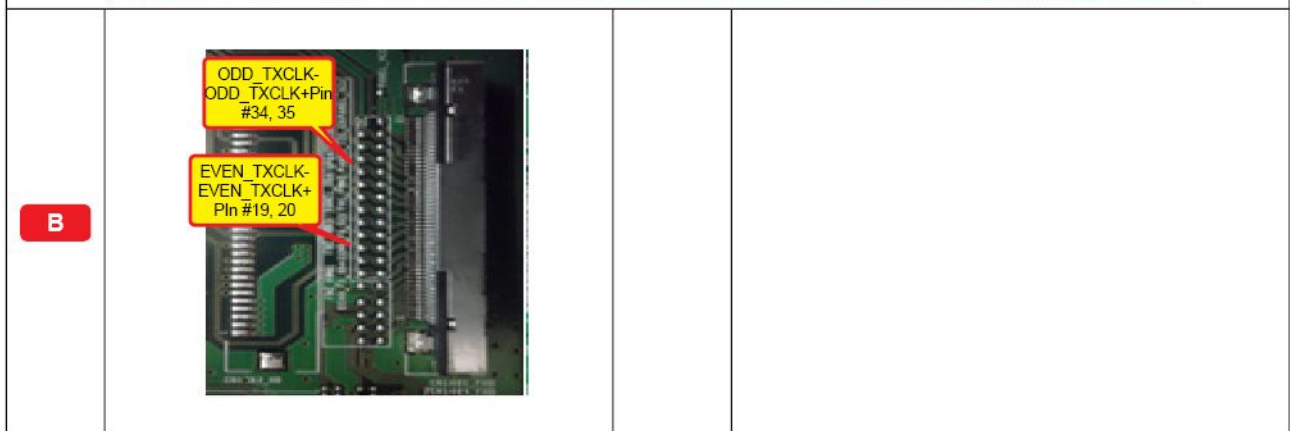

■ No Video (1.Speaker 2.Headphone_out, 3.Optical)



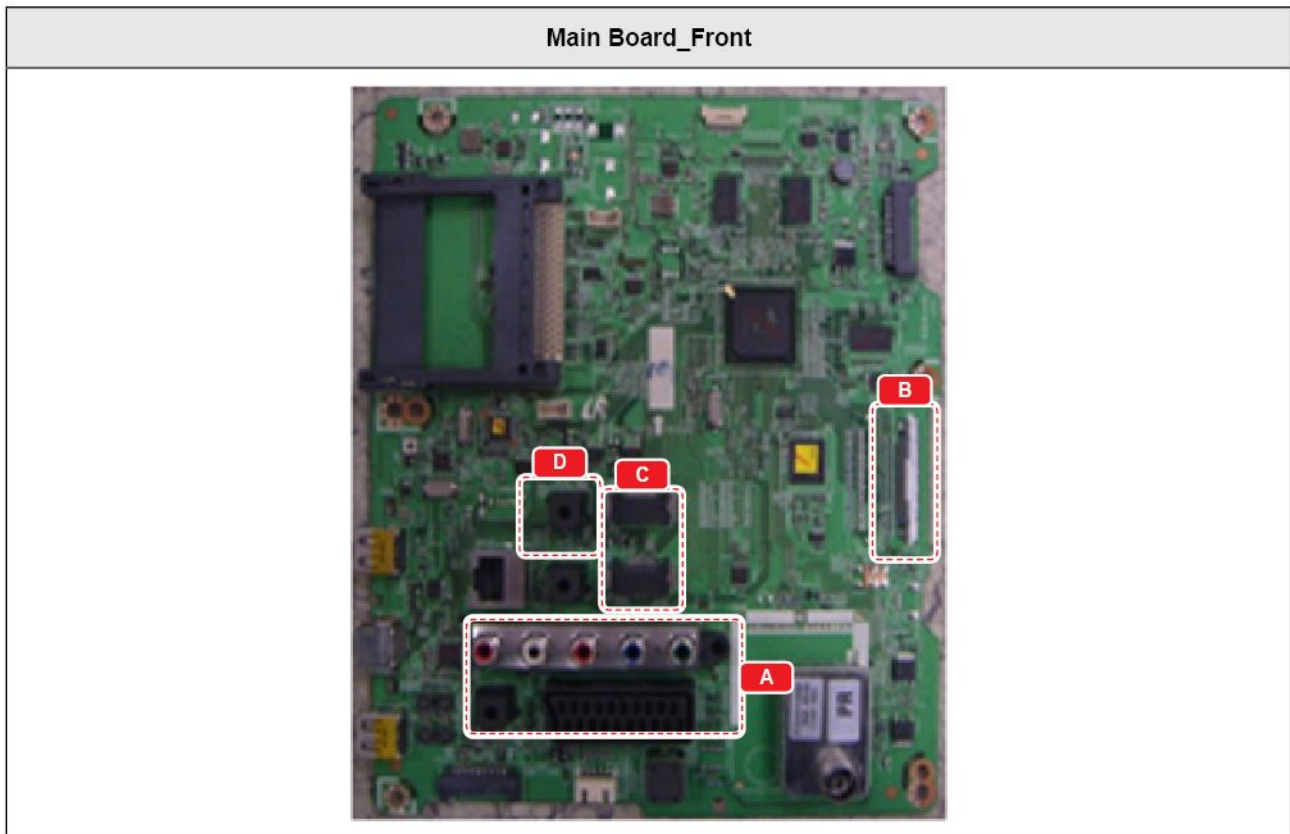

*Refer to the next page to check the location such a CN201 or IC1001 SVC Manual mentioned.

Symptom	<ul style="list-style-type: none"> • Video is normal, but there is no sound.
Major checkpoints	<ul style="list-style-type: none"> • When the speaker connects are disconnected or damaged. • When the sound processing part of the Main board is not Functioning. • Speaker defect.
Diagnostics	<pre> graph TD Q1[Check the source and check the connection of sound cable (Comp, SCART, HDMI) ?] -- No --> A1[Input the sound source properly.] Q1 -- Yes --> Q2[Check the signal at input of Main board?] Q2 -- No --> A2[Check CN501, CN502, CN601,2,3. Change the Main Board.] Q2 -- Yes --> Q3[1. Check the DATA between the Audio IC's ? Pin #4 of IC301 : LR_clk Pin #3 of IC301 : I2S_DATA] Q3 -- No --> A3[Check IC301. Change the Main Board.] Q3 -- Yes --> Q4[2. 1. Check the Speaker sound data at CN301 2. Check the Monitor out sound data at CN302 3. Does the SDIF OUT sound data appear at ? OP301] Q4 -- No --> A4[Check IC301. Change the Main Board.] Q4 -- Yes --> Q5[Replace speaker ?] Q5 -- No --> A5[Please, Contact Tech support.] </pre>
Caution	<p>Make sure to disconnect the power before working on the Power board.</p>

■ Location of Parts



Detail

<p>A</p> 		<p>B</p> 	
<p>C</p> 		<p>D</p> 	

4.3. Factory Mode Adjustments

4-3-1. Entering Factory Mode

To enter 'Service Mode' Press the remote -control keys in this sequence :

- If you do not have Factory remote control



- If you have Factory remote control

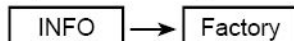

- If you don't have Factory remote control, can't control some menus. (Expert, Advanced menu)

Option	T-MST10PDEUC-****
Control	T-MST10PDEUCS-****
SVC	E-Manual : XTDVBEUE-****
Expert	EDID SUCCESS
ADC/WB	HDCP SUCCESS
Advanced	CALIB : AV/COMP/PC/HDMI/
	Option : *****
	FactoryCS : 0x****
	T-MSXDEUCIP-****
	Onboot : ****
	SDAL_****
	RFS : "X10P *****"
	2012-**-**
	FUNC-TAG-ERR
	Type :****
	Model : ****
	Wired MAC SUCCESS
	CIP SUCCESS
	DRM ****
	Factory Data Ver : ***
	EERC Version : ****
	DTP-AP-COMP-***
	DTP-BP-HAL-***
	DTP-BP-***
	POP-FLA-****
	Date of purchase : mm/dd/yyyy

4-3-2. Factory Data

■ Option

Factory Menu Name	Data	Range
Factory Reset		
Type		
Local Set		
Model		
SVC Model		
Tuner		
Ch Table		
Front Color		

■ Control

Factory Menu Name	Data	Range
EDID		
EDID ON/OFF		ON/OFF
EDID WRITE ALL		
EDID WRITE PC		
EDID WRITE HDMI		
EDID WRITE HDMI1		
EDID WRITE HDMI2		
EDID WRITE HDMI3		
EDID WRITE HDMI4		
EDID WRITE PC		
EDID Ver		
EDID PORT		
EDID WRITE DVI		
Sub Option		
RF Mute Time	600ms	
RS-232 Jack	UART	Debug / UART
Watchdog	OFF	OFF / ON
WD COUNT	0	
LVDS FORMAT	JEIDA	
Language_Arabic	EU	
TOOLS Support	57	
LNA Support	0	
NETWORK Support	Ext-Wifi	

Factory Menu Name	Data	Range
IPERF	Stopped	
Info Link Server Type	operating	
Info Link Country	None	
TTX List	flof	
TTX Group	UserOSD	
24Px4 Support	OFF	
Power Indicator Support	ON	
BD Wise Support	OFF	
Data Service Support	OFF	
IIC Bus Stop	OFF	
Visual Test	Disable	
Emergency Log Copy		
Checksum	0x0000	
View Log		
Select Log Type	MICOM	
Log View		
Delete Log		
Gemstar On/Off	OFF	
WSS Support	ON	
PVR Support	ON	
CI Support	ON	
Eeprom Reset		
Spread Spectrum		
LVDS Spread	ON	
Period	40K	
Amplitude	1.4	
DDR Spread	1.0% Spread	
Echo-FS LVDS SSC ON/OFF	0	
Echo-FS LVDS SSC MFR	1	
Echo-FS LVDS SSC MRR	10	
Echo-FS DDR SSC ON/OFF	1	
Echo-FS DDR SSC MFR	1	
Echo-FS DDR SCC MRR	15	
NT72312 LVDS SSC ON/OFF	ON	
NT72312 LVDS SSC Period	30K	
NT72312 LVDS SSC Modulation	1.00%	

4. Troubleshooting

Factory Menu Name	Data	Range
NT72312 DDR SSC ON/OFF	ON	
NT72312 DDR SSC Period	30K	
NT72312 DDR SSC Modulation	1.00%	
Echo-FP LVDS SSC ON/OFF		
Echo-FP LVDS SSC MFR		
Echo-FP LVDS SSC MRR		
Echo-FP DDR SSC ON/OFF		
Echo-FP DDR SSC MFR		
Echo-FP DDR SCC MRR		
DDR Margin		
A CTRL_OFFSET_0_3	0x0	
A CTRL_OFFSET_D	0x0	
B CTRL_OFFSET_0_3	0x0	
B CTRL_OFFSET_D	0x0	
H.264 Margin	8	
MPEG Margin	1000	
2nd mips	ON	
2nd mips count	0	
Region	PANEURO	
PnP Language	ENG	
PC Auto Ident	Enable	
OTP Lock	...	
Auto Power	MEMORY	
Key SENSITIVITY	Not used	
OTA Support	General	
FKP Down		
WIFI REGION	E	
e-Pop Default	ON	
OPTION_SWU		
OPTION_MEDIAPLAY		
3D OPTIMIZE VALUE	1	
ECO IC TYPE	NLS1006	
Energy Star Logo	OFF	
Fast USB Booting	ON	
Nume of Network Stream	0	
CI+1.3	OFF	

Factory Menu Name	Data	Range
Hotel Option		
Hospitality Mode	OFF	
Power On	...	
Menu OSD	...	
Operation	...	
Music Mode	...	
External Source	...	
Eco Solution	...	
Cloning	...	
Shop Option		
Shop Mode	OFF	
Exhibition Mode	OFF	
3D Cube	OFF	
Asia Option		
TTX	OFF	
China HD	OFF	
NT Conversion	OFF	
Seppo 120Hz	OFF	
Unbalance	OFF	
FMTransmitter Support	OFF	
FMTransmitter Carrier	OFF	
AF Level adjust	3	
TX Power Level	0	
Mono Last Memory	OFF	
H Shaking	OFF	
Sound		
High Devi	OFF	
Carrier Mute	ON	
Volume Curve	Type1	
Speaker Delay Normal	60	
Pilot Level High Thld	0x28h	
Pilot Level Low Thld	0x10h	
FM Prescale	68	
AM Prescale	49	
NICAM Prescale	45	
Amp Volume	0xC7h	

4. Troubleshooting

Factory Menu Name	Data	Range
Amp Scale	0x8eh	
Amp Check Sum	0x009CD116	
Woofer Type	1	
Woofer Scale	0x8ah	
Woofer Check Sum		
Speaker EQ	ON	
PEQ Test	0	
Amp Model	NTP7412	
Speaker cut-off Freq	4	
SPDIF PCM Gain	-9	
FM M Prescale	48	
BTSC Mono Prescale	25	
BTSC stereo Prescale	47	
SAP Prescale	43	
A2Ident High Thid	31	
A2Ident Low Thid	2	
Carrier2 Amp High Thld	4	
Carrier2 Amp Low Thld	3	
Carrier2 SNR High THR	16	
Carrier2 SNR Low THR	80	
Audio-IP Test	Ready	
TruBass CheckSum	0xFFFFFFFF	
PWM Mode	BD	
Mic Scale	0	
SubWoofer Support	0	
India Sound	OFF	
Config Option		
Num of ATV	1	
Num of DTV	1	
Num of AV	1	
Num of SVIDEO	0	
Num of COMP	1	
Num of HDMI	3	
Num of PC	0	
Num of SCART	1	
Num of DVI	0	

Factory Menu Name	Data	Range
Num of OPTICAL Link	1	
Num of MEDIA	1	
Num of PANEL KEY	6	
Num of USB Port	2	
Num of HeadPhone	1	
Num of RVU	0	
MFT Offset	62.5	
Select LCD/PDP	LCD	
HDMI/DVI SEL	1	
Indicator Led	OFF	
Wall Mount	OFF	
HV Flip	ON	
Num Of Display	2	
DVI/HDMI SOUND	Auto	
HDMI HOT PLUG	Disable	
HOTPLUG SWITCHING	Boot	
HOTPLUG DURATION	1200ms	
CLK TERM DURATION	1200ms	
HDMI FLT CNT SIG	100ms	
HDMI FLT CNT LOS	100ms	
UNSTABLE BAN CNT	3000ms	
HDMI Err Cnt	1	
HDMI ROBIN	ON	
HDMI Callback	OFF	
HDMI CTS Thld	8	
HDMI CTS Cnt1	1	
HDMI EQ	AUTO	AUTO/Low/Middle/High/Strong
HDMI Write Type	Separate	
HDMI Switch	NONE	
DVI SET TIME	300ms	
Type Of PANEL KEY	None	
EcoSensor Support	ON	
LEDMotionPlus Support	ON	
Natural Mode Support	ON	
All Share Support	ON	
Relax Mode Support	OFF	

4. Troubleshooting

Factory Menu Name	Data	Range
BT Support	OFF	
3D Support	OFF	
H Write		
HDMI Sync	DE	
HeadPhone Port		
FANET	OFF	
Support MultiMedia Key	ON	
Config_AV_PATH		
Num of IPTV	0	
PVR RECORD NUM	1	
Num of RUI	0	
5 Way Function Key	R BACK	
Contents Bar	OFF	
Num of Tuner	1	
HDMI 3D DET	1	

■ SVC

Factory Menu Name	Data	Range
Test pattern		
LOGIC Pattern Sel	...	
LOGIC Level Sel	...	
Echo-FS Pre Test Pattern	0	
Echo-FS Post Test Pattern	0	
Echo-FS FRC FDISPLY ON/OFF	OFF	
Echo-FS 3D FDISPLAY ON/OFF	OFF	
Echo-FS PC Mode ON/OFF	OFF	
NT72312 Pre Test Pattern	0	
NT72312 Post Test Pattern	0	
NT72312 PC mode ON/OFF	OFF	
Echo-FP Pre Test Pattern	0	
Echo-FP Post Test Pattern	0	
Echo-FP FRC FDISPLY ON/OFF	OFF	
Echo-FP 3D FDISPLAY ON/OFF	0	
Panel Diplay Time	2Hr	
LOGIC Usb D/L	...	
Tuner Status		
T-CON Usb Download	Failure	

Factory Menu Name	Data	Range
T-CON Checksum		
Tuner Margin	10	
CAM Wait Time		
TS Clock delay	0	
SUBMICOM UPGRADE	Off	
BT ADDRESS	0	
BT UPGRADE		
BT FREEPAIRING	ON	
SVC Reset		
TCON_TEMP READ	0	
TEMP LAST	60	
DCC VERSION	0x0	
DCC CHK SEL	0	
DCC CHECK LOCAL	0x0	
DCC CHECK TOTAL		
Function Upgrade	Off	
Smart Hub Reset	Off	
WIFI ER COUNT	0	
BT ER COUNT	0	
Debug Log Down		
MultiACC Checksum	Error	
SVC Info		
TS Clock delay TC	0	
TS Clock delay S	0	
CAL Data Backup	...	
CAL Data Restore	...	

■ Expert

Factory Menu Name	Data	Range
N/D ADJ	OFF	
Source	...	

■ ADC/WB

Factory Menu Name	Data	Range
ADC		
AV Calibration	Success	
Comp Calibraion	Success	

4. Troubleshooting

Factory Menu Name	Data	Range
PC Calibration	Success	
HDMI Calibration	Success	
ADC Target		
1st_AV_Low	64	
1st_AV_High	880	
1st_AV_Delta	2	
1st_COMP_Y_Low	64	
1st_COMP_Cb_Low	512	
1st_COMP_Cr_Low	512	
1st_COMP_Y_High	940	
1st_COMP_Cb_High	512	
1st_COMP_Cr_High	512	
1st_COMP_Delta	2	
1st_PC_Low	4	
1st_PC_High	1004	
1st_PC_Delta	2	
2nd_ACH_Low	4	
2nd_ACH_High	940	
2nd_PC_Low	4	
2nd_PC_High	940	
2nd_Delta	2	
ADC Result		
1st_Y_GH	0	
1st_Y_GL	...	
1st_Cb_BH	0	
1st_Cb_BL	0	
1st_Cr_RH	0	
1st_Cr_RL	0	
2nd_R_L	134	
2nd_G_L	134	
2nd_B_L	134	
2nd_R_H	49	
2nd_G_H	49	
2nd_B_H	49	
WB		
Sub Brightness	128	

Factory Menu Name	Data	Range
R-Offset	128	
G-Offset	128	
B-Offset	128	
Sub Contrast	128	
R-Gain	128	
G-Gain	128	
B-Gain	128	
Movie R-Offset	...	
Movie B-Offset	...	
Movie R-Gain	...	
Movie B-Gain	...	

4.4. White Balance

4-4-1. Calibration

1. Into the Factory Mode.
2. Select **SVC** Menu.
3. Select **ADC/WB** menu.
4. Select **ADC** menu.

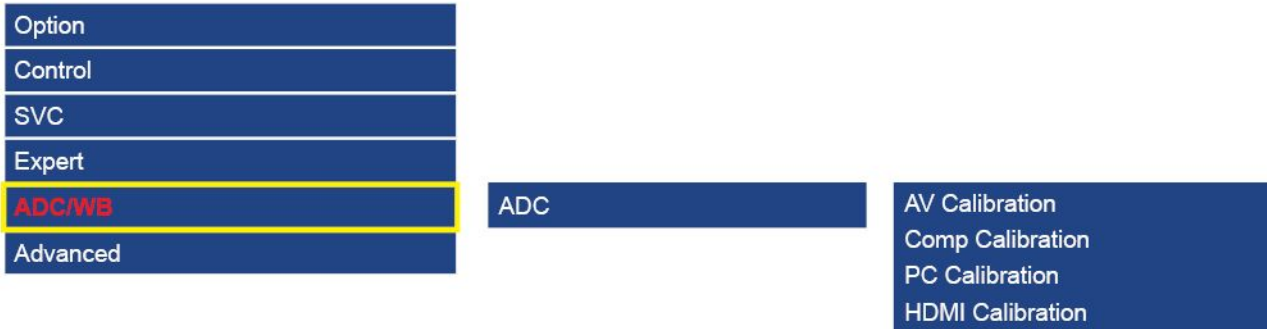

NOTE

Our Model do not support PC Mode (Except E5400 Model).

4-4-2. Service Adjustment

You must perform Calibration in the Lattice Pattern before adjusting the White Balance.

■ Color Calibration

- Adjust Specification

Source	Setting Mode	Pattern	Use Equipment
HDMI	1280 x 720@60 Hz	Pattern #24 (Chess Pattern)	CA210 & MIK K-7256

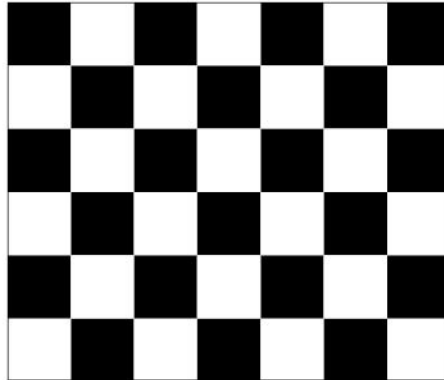

(Chess Pattern)

- Use other equipment only after comparing the result with that of the Master equipment.

Input mode	Calibration	Pattern
CVBS IN (Time_#2)	Perform in PAL B&W Pattern #24	Lattice
Component IN (Time_#6)	Perform in 720p B&W Pattern #24	Lattice
HDMI IN (Time_#6)	Perform in 720p B&W Pattern #24	Lattice
PC Analog IN (Time_#21)	Perform in VESA XGA (1024*768) B&W Pattern #24	Lattice

NOTE

PC Analog IN (Time_#21) : E5400 PC Mode Only.

■ Method of Color Calibration (AV)

1. Apply the NTSC Lattice (N0. 3) pattern signal to the AV IN 1 port.
2. Press the Source key to switch to "AV1" mode.
3. Enter Service mode.
4. Select the "ADC" menu.
5. Select the "AV Calibration" menu.
6. In "AV Calibration Off" status, press the "▶" key to perform Calibration.
7. When Calibration is complete, it returns to the high-level menu.
8. You can see the change of the "AV Calibration" status from Failure to Success.

■ Method of Color Calibration (Component)

1. Apply the 720p Lattice (N0. 6) pattern signal to the Component IN 1 port.
2. Press the Source key to switch to "Component1" mode.
3. Enter Service mode.
4. Select the "ADC" menu.
5. Select the "Comp Calibration" menu.
6. In "Comp Calibration Off" status, press the "▶" key to perform Calibration.
7. When Calibration is complete, it returns to the high-level menu.
8. You can see the change of the "Comp Calibration" status from Failure to Success.

■ Method of Color Calibration (PC)_ E5400 Model Only

1. Apply the VESA XGA Lattice (N0. 21) pattern signal to the PC IN port.
2. Press the Source key to switch to "PC" mode.
3. Enter Service mode.
4. Select the "ADC" menu.
5. Select the "PC Calibration" menu.
6. In "PC Calibration Off" status, press the "▶" key to perform Calibration.
7. When Calibration is complete, it returns to the high-level menu.
8. You can see the change of the "PC Calibration" status from Failure to Success.

■ Method of Color Calibration (HDMI)

1. Apply the 720p Lattice (N0. 6) pattern signal to the HDMI1/DVI IN port.
2. Press the Source key to switch to "HDMI1" mode.
3. Enter Service mode.
4. Select the "ADC" menu.
5. Select the "HDMI Calibration" menu.
6. In "HDMI Calibration Off" status, press the "▶" key to perform Calibration.
7. When Calibration is complete, it returns to the high-level menu.
8. You can see the change of the "HDMI Calibration" status from Failure to Success.

4-4-3. Adjustment

1. Into the Factory Mode.
2. Select **SVC** Menu.
3. Select **ADC/WB** menu.
4. Select **White Balance** menu.

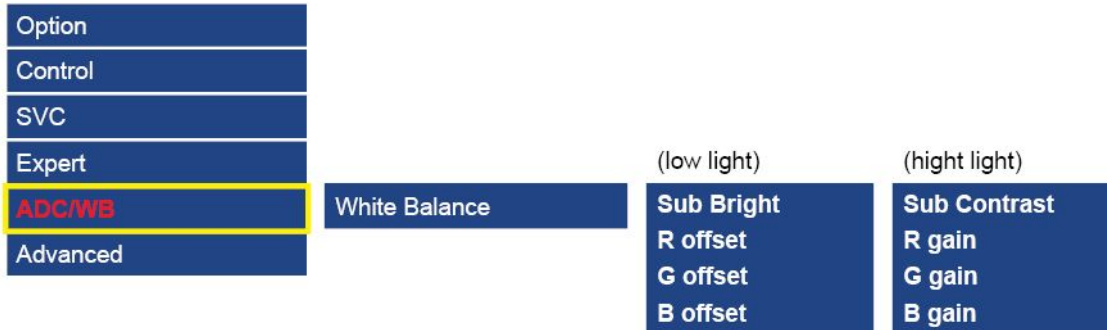

4.5. White Ratio (Balance) Adjustment

1. You can adjust the white ratio in factory mode (1:Calibration, 3:White-Balance).
2. Since the adjustment value and the data value vary depending on the input source, you have to adjust these in CVBS, Component 1 and HDMI 1 modes.
3. The optimal values for each mode are configured by default. It varies with Panel's size and Specification.
 - Equipment : CS-210
 - Pattern: MIK K-7256 #92 "Flat W/B Pattern" as standard
 - Alternate Equipment : CA200& anyone Master supported pattern#92(refer to right photo)
 - Use other Equipment only after comparing the result with that of the Master equipment.
 - Set Aging time : 60 min



Calibration and Manual setting for WB adjustment

- HDMI : Calibration at #24 Chessboard Pattern Manual adjustment at #92 pattern (720p)
- COMP: Calibration at #24 Chessboard Pattern Manual adjustment at #92 pattern (720p)
- CVBS: Calibration at #24 Chessboard Pattern Manual adjustment at #92 pattern (PAL)



Note

If finishing in HDMI mode, adjustment coordinate is almost same in AV/COMP mode.

White Balance Manual adjustment

- UE32ES55**/57**/58**

P-Mode Input source	Section	Adjustment Coordinate CA-210					
		Hx	264	Hy	274	HY	NA
HDMI COMP VIDEO	W/B High	Lx	NA	Ly	NA	LY	NA
	W/B Low	Hx	318	Hy	340	HY	NA
MOVIE	W/B High	Lx	NA	Ly	NA	LY	NA
	W/B Low	Hx	264	Hy	274	HY	NA

Sub Contrast	135	Sub Bright	128		
R-Gain	ADJ	G-Gain	128	B-Gain	ADJ
R-Offset	128	G-Offset	128	B-Offset	128

• UE37ES55**/57**

P-Mode Input source	Section		Adjustment Coordinate CA-210					
HDMI COMP VIDEO	W/B High		Hx	264	Hy	274	HY	NA
	W/B Low		Lx	NA	Ly	NA	LY	NA
MOVIE	W/B High		Hx	318	Hy	340	HY	NA
	W/B Low		Lx	NA	Ly	NA	LY	NA
Sub Contrast	135	Sub Bright	128					
R-Gain	ADJ	G-Gain	128	B-Gain		ADJ		
R-Offset	128	G-Offset	128	B-Offset		128		

• UE40ES55**/57**/58**

P-Mode Input source	Section		Adjustment Coordinate CA-210					
HDMI COMP VIDEO	W/B High		Hx	264	Hy	274	HY	NA
	W/B Low		Lx	NA	Ly	NA	LY	NA
MOVIE	W/B High		Hx	318	Hy	340	HY	NA
	W/B Low		Lx	NA	Ly	NA	LY	NA
Sub Contrast	135	Sub Bright	128					
R-Gain	ADJ	G-Gain	128	B-Gain		ADJ		
R-Offset	128	G-Offset	128	B-Offset		128		

• UE46ES55**/57**/58**

P-Mode Input source	Section		Adjustment Coordinate CA-210					
HDMI COMP VIDEO	W/B High		Hx	264	Hy	274	HY	NA
	W/B Low		Lx	NA	Ly	NA	LY	NA
MOVIE	W/B High		Hx	318	Hy	340	HY	NA
	W/B Low		Lx	NA	Ly	NA	LY	NA
Sub Contrast	135	Sub Bright	128					
R-Gain	ADJ	G-Gain	128	B-Gain		ADJ		
R-Offset	128	G-Offset	128	B-Offset		128		

4. Troubleshooting

- UE50ES55**/57**

P-Mode Input source	Section		Adjustment Coordinate CA-210					
			Hx	264	Hy	274	HY	NA
HDMI COMP VIDEO	W/B High		Hx	264	Hy	274	HY	NA
	W/B Low		Lx	NA	Ly	NA	LY	NA
MOVIE	W/B High		Hx	318	Hy	340	HY	NA
	W/B Low		Lx	NA	Ly	NA	LY	NA
Sub Contrast	135	Sub Bright	128					
R-Gain	ADJ	G-Gain	128	B-Gain		ADJ		
R-Offset	128	G-Offset	128	B-Offset		128		

- UE32EH53**/UE32EH5450W

P-Mode Input source	Section		Adjustment Coordinate CA-210					
			Hx	264	Hy	274	HY	NA
HDMI COMP VIDEO	W/B High		Hx	264	Hy	274	HY	NA
	W/B Low		Lx	NA	Ly	NA	LY	NA
MOVIE	W/B High		Hx	318	Hy	340	HY	NA
	W/B Low		Lx	NA	Ly	NA	LY	NA
Sub Contrast	135	Sub Bright	128					
R-Gain	ADJ	G-Gain	128	B-Gain		ADJ		
R-Offset	128	G-Offset	128	B-Offset		128		

- UE37EH53**

P-Mode Input source	Section		Adjustment Coordinate CA-210					
			Hx	264	Hy	274	HY	NA
HDMI COMP VIDEO	W/B High		Hx	264	Hy	274	HY	NA
	W/B Low		Lx	NA	Ly	NA	LY	NA
MOVIE	W/B High		Hx	318	Hy	340	HY	NA
	W/B Low		Lx	NA	Ly	NA	LY	NA
Sub Contrast	135	Sub Bright	128					
R-Gain	ADJ	G-Gain	128	B-Gain		ADJ		
R-Offset	128	G-Offset	128	B-Offset		128		

- UE40EH53**/UE40EH5450W

P-Mode Input source	Section		Adjustment Coordinate CA-210					
			Hx	264	Hy	274	HY	NA
HDMI COMP VIDEO	W/B High		Hx	264	Hy	274	HY	NA
	W/B Low		Lx	NA	Ly	NA	LY	NA
MOVIE	W/B High		Hx	318	Hy	340	HY	NA
	W/B Low		Lx	NA	Ly	NA	LY	NA
Sub Contrast	135	Sub Bright	128					
R-Gain	ADJ	G-Gain	128	B-Gain		ADJ		
R-Offset	128	G-Offset	128	B-Offset		128		

- UE46EH53**/UE46EH5450W

P-Mode Input source	Section		Adjustment Coordinate CA-210					
			Hx	264	Hy	274	HY	NA
HDMI COMP VIDEO	W/B High		Hx	264	Hy	274	HY	NA
	W/B Low		Lx	NA	Ly	NA	LY	NA
MOVIE	W/B High		Hx	318	Hy	340	HY	NA
	W/B Low		Lx	NA	Ly	NA	LY	NA
Sub Contrast	135	Sub Bright	128					
R-Gain	ADJ	G-Gain	128	B-Gain		ADJ		
R-Offset	128	G-Offset	128	B-Offset		128		

- UE50EH53**

P-Mode Input source	Section		Adjustment Coordinate CA-210					
			Hx	264	Hy	274	HY	NA
HDMI COMP VIDEO	W/B High		Hx	264	Hy	274	HY	NA
	W/B Low		Lx	NA	Ly	NA	LY	NA
MOVIE	W/B High		Hx	318	Hy	340	HY	NA
	W/B Low		Lx	NA	Ly	NA	LY	NA
Sub Contrast	135	Sub Bright	128					
R-Gain	ADJ	G-Gain	128	B-Gain		ADJ		
R-Offset	128	G-Offset	128	B-Offset		128		

4. Troubleshooting

- UE26EH45**

P-Mode Input source	Section	Adjustment Coordinate CA-210					
		Hx	264	Hy	274	HY	NA
HDMI COMP VIDEO	W/B High	Lx	NA	Ly	NA	LY	NA
	W/B Low	Hx	318	Hy	340	HY	NA
MOVIE	W/B High	Lx	NA	Ly	NA	LY	NA
	W/B Low						

Sub Contrast	135	Sub Bright	128		
R-Gain	ADJ	G-Gain	128	B-Gain	ADJ
R-Offset	128	G-Offset	128	B-Offset	128

- UE22EH54**

P-Mode Input source	Section	Adjustment Coordinate CA-210					
		Hx	281	Hy	288	HY	NA
HDMI COMP VIDEO	W/B High	Lx	NA	Ly	NA	LY	NA
	W/B Low	Hx	NA	Hy	NA	HY	NA
MOVIE	W/B High	Lx	NA	Ly	NA	LY	NA
	W/B Low						

Sub Contrast	128	Sub Bright	128		
R-Gain	ADJ	G-Gain	128	B-Gain	ADJ
R-Offset	128	G-Offset	128	B-Offset	128

4.6. RS-232C

RS232C Control

- Port : COM#(Serial)
- Bit rate : 38400(Control)
- Data Bit : 8 bit
- Parity : None
- Stop Bits : 1
- Flow Control : None

How to connect to TV set

If TV set do not have MAX3232E circuit, you need Jig board and cables. (Refer to below picture and description.)

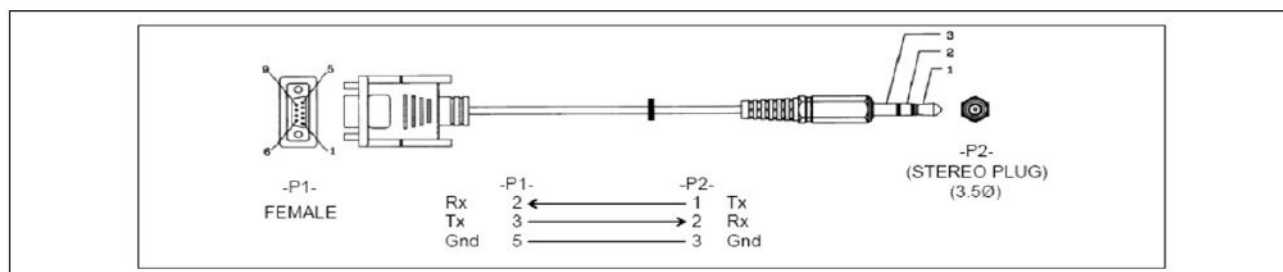
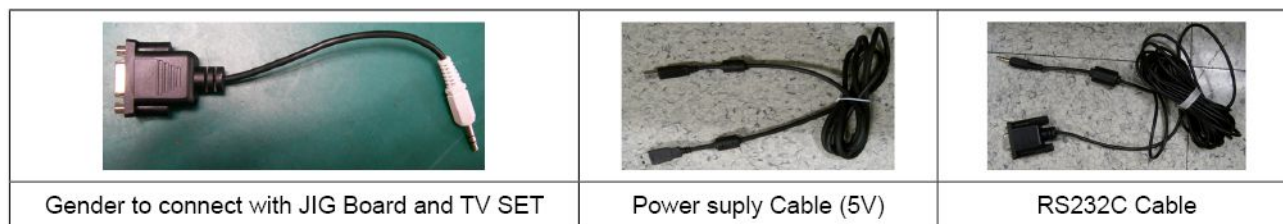
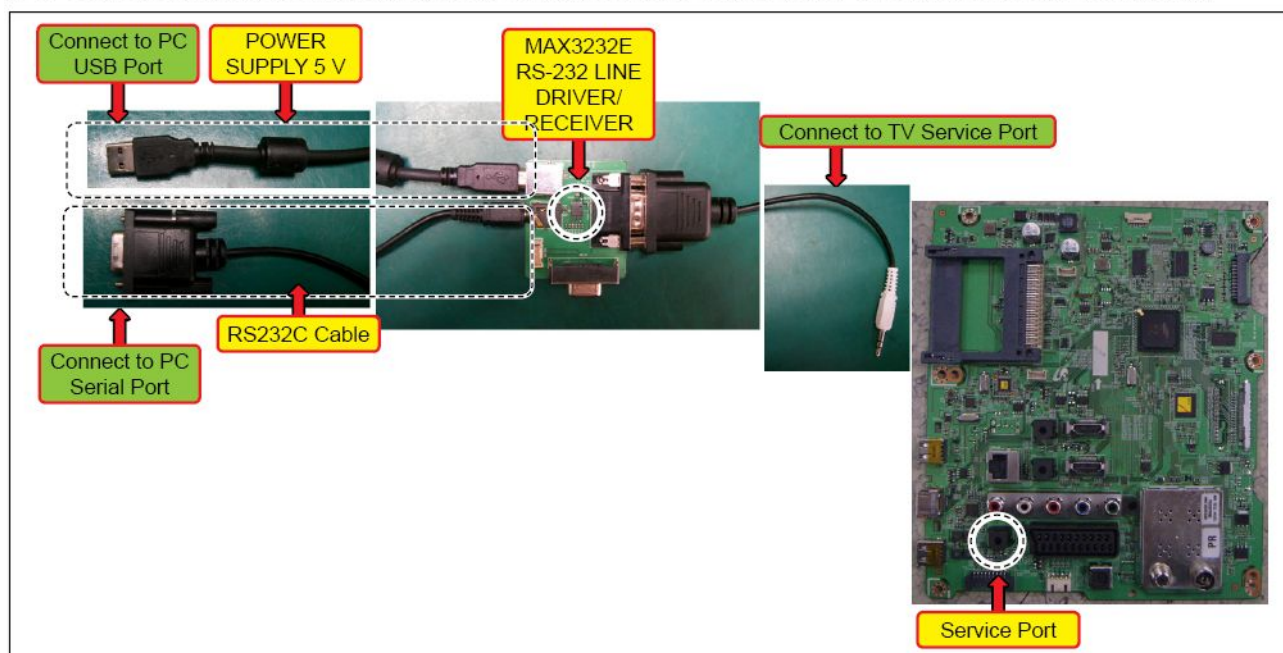

Description of RS232C

Pin#	Name	Full Name	Pin#	Name	Full Name	Pin#	Name	Full Name
1	CD	Carrier Detect	4	DTR	Data Terminal Ready	7	RTS	Request To Send
2	RxD	Received Data	5	GND	Signal Ground	8	CTS	Clear To Send
3	TxD	Transmitted Data	6	DSR	Data Set Ready	9	RI	Ring Indicator

4.7. Software Upgrade

Samsung may offer upgrades for the TV's firmware in the future. These upgrades can be performed via the TV when it is connected to the Internet, or by downloading the new firmware from samsung.com to a USB memory device.

- Alternative Software (Backup) shows The previous version that will be replaced.
- Software is represented as 'Year/Month/Day_Version'. The more recent the date, the newer the software version. Installing the latest version is recommended.

4-7-1. By USB

Insert a USB drive containing the firmware upgrade downloaded from samsung.com into the TV. Please be careful to not disconnect the power or remove the USB drive while upgrades are being applied. The TV will turn off and turn on automatically after completing the firmware upgrade. Please check the firmware version after the upgrades are complete (the new version will have a higher number than the older version). When software is upgraded, video and audio settings you have made will return to their default (factory) settings. We recommend you write down your settings so that you can easily reset them after the upgrade.



4-7-2. Online

Upgrades the software using the Internet.

- First, configure your network. For detailed procedures on using the Network Setting, refer to the 'Setting the Network' instructions.
- If The internet connection doesn't operate properly, connection can be broken, please retry downloading.

If the problem still happens, download by USB and upgrade.

4-7-3. Alternative Software (Backup)

If there is an issue with the new firmware and it is affecting operation, you can change the software to the previous

- If Software was changed, existing Software is displayed.
- you can change current Software to Alternative Software by 'Alternative Software'.

4-7-4. How to Check the Software Version (By USB)

■ Use the Main Menu

1. Click the "MENU" key in remote controller.
2. Select "Support" menu.
3. Locate the menu cursor "Software Upgrade" menu.
4. Click the "INFO" key.
 - Check the Main SW and Micom version.

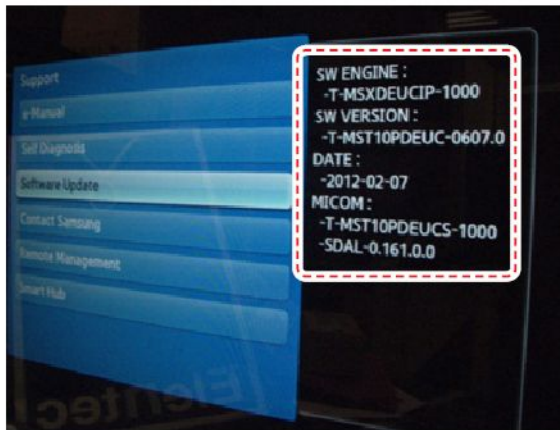

■ Use the Factory Mode

Option	T-MST10PDEUC-****
Control	T-MST10PDEUCS-****
SVC	E-Manual : XTDVBEUE_****
Expert	EDID SUCCESS
ADC/WB	HDCP SUCCESS
Advanced	CALIB : AV / COMP / PC / HDMI
	Option : ****
	FactoryCS : 0x****
	T-MSXDEUCIP_****
	Type : ****
	Model : ****
	Wired MAC SUCCESS
	CIP SUCCESS
	Date of purchase : --/--/----
	Main SW Version
	SubMicom SW Version

4-7-5. How to Upgrade Software and Micom

Insert a USB drive containing the firmware upgrade downloaded from samsung.com into the TV. Please be careful not to disconnect the power or remove the USB drive while upgrades are being applied. The TV will turn off and turn on automatically after completing the firmware upgrade. Please check the firmware version after the upgrades are complete (the new version will have a higher number than the older version). When software is upgraded, video and audio settings you have made will return to their default (factory) settings. We recommend you write down your settings before beginning firmware update. After update is completed, restore your previous settings.

■ Main Software Upgrade

1. Store the sw program named "T-MST10DEU" in USB memory stick
 - Connect the USB.



2. Click the "MENU" key in Remote Controller.
3. Select "Support" menu.
Locate the menu cursor "Software Upgrade" menu.

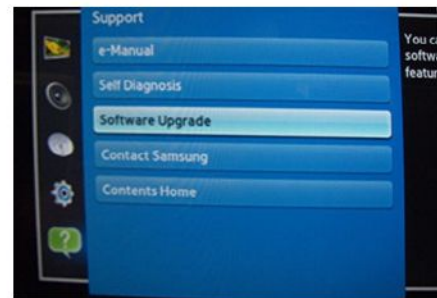

4. Locate the menu cursor "By USB" menu.

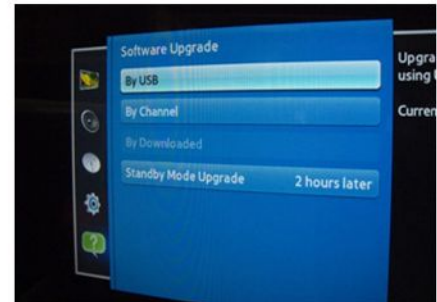

5. Click the "ENTER" key.
6. Click the "ENTER" key.
 - Wait for upgrade complete.
 - Check the Software Version.

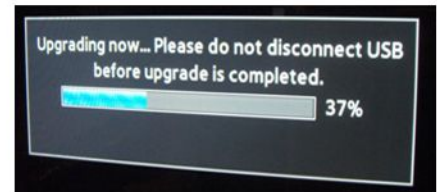
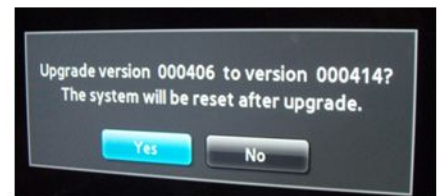

■ Submicom Software Upgrade

1. Store the sw program folder named ""SubMicomEU_X10****.bin" in USB memory stick.
 - Connect the USB.



2. Access the factory mode.
 - Locate the cursor "SVC" menu.

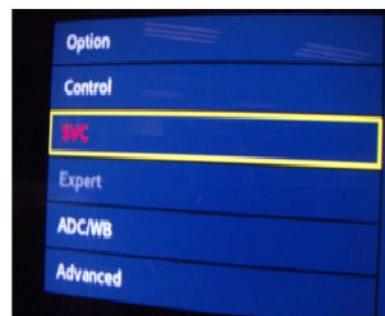

3. Click the "ENTER" key.
 - Locate the cursor "SUBMICOM UPGRADE" menu.

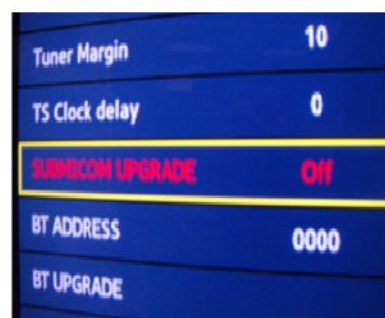

4. Click the "ENTER" key
 - Change the "Wait" to "On"
 - Wait for upgrade complete.
 - Check the submicom SW version.

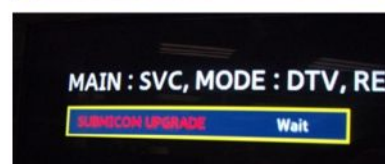

4.8. Cover-Middle Rear Dimension

■ UE32ES55** (57**/58**)

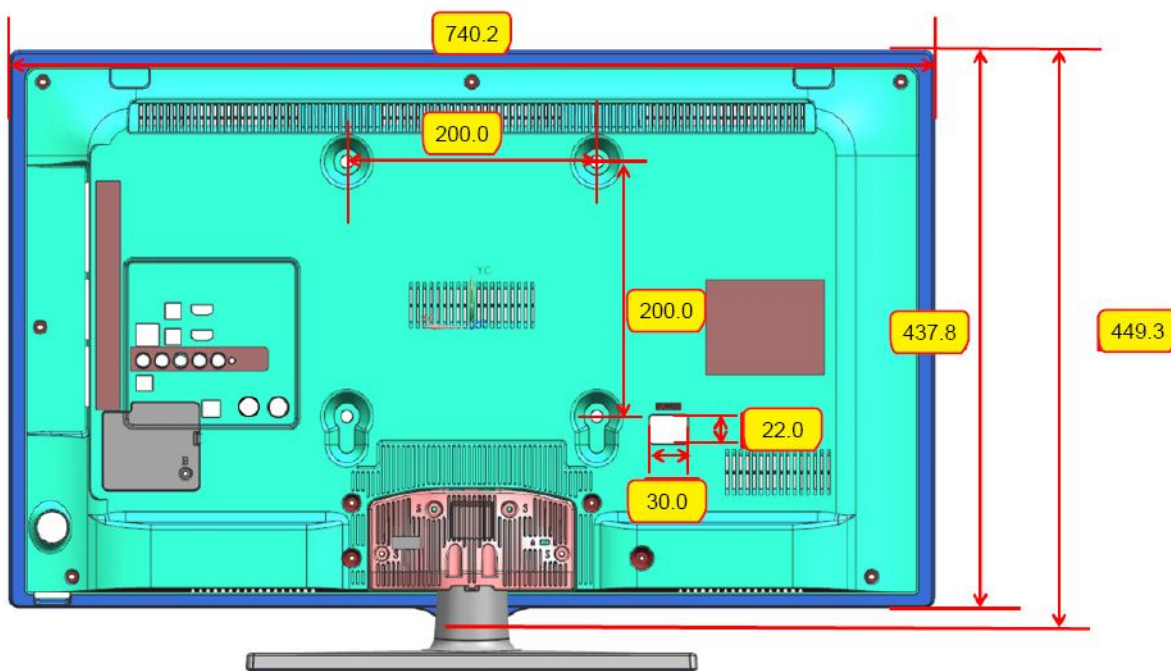

■ UE37ES55** (57**)

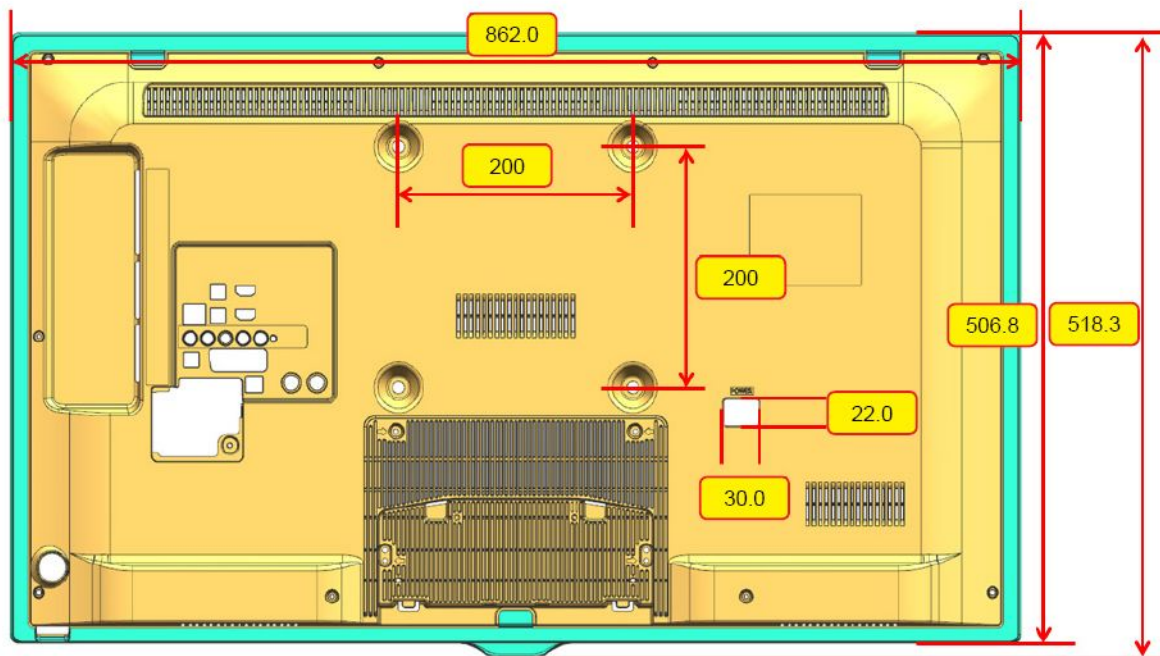

■ UE40ES55** (57**/58**)

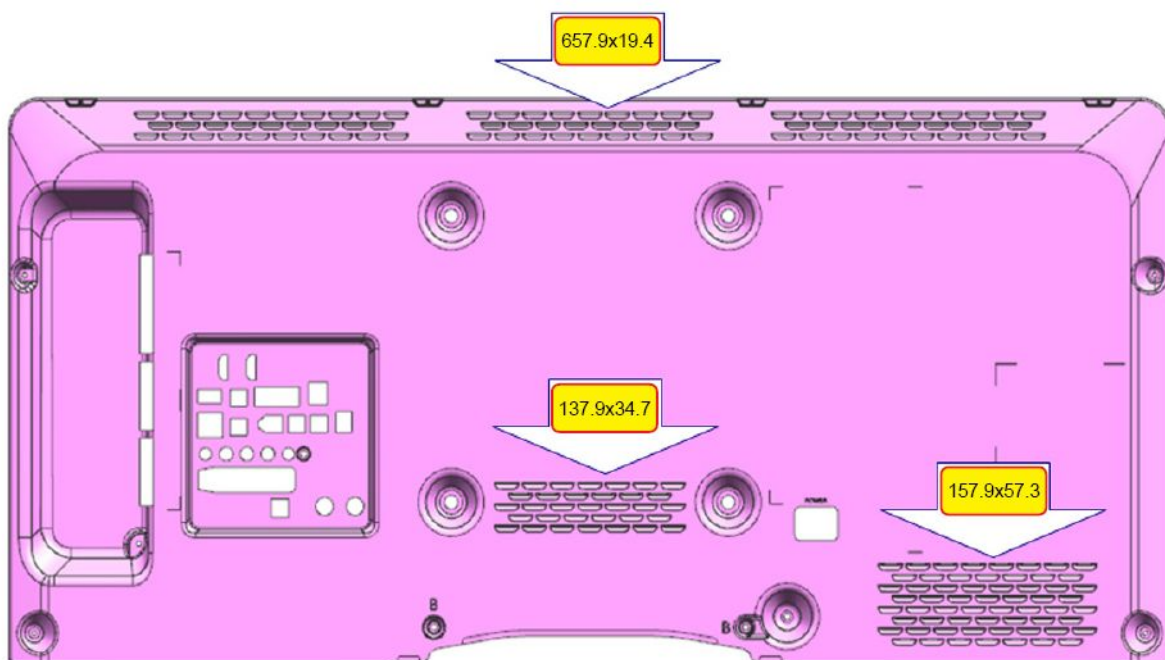
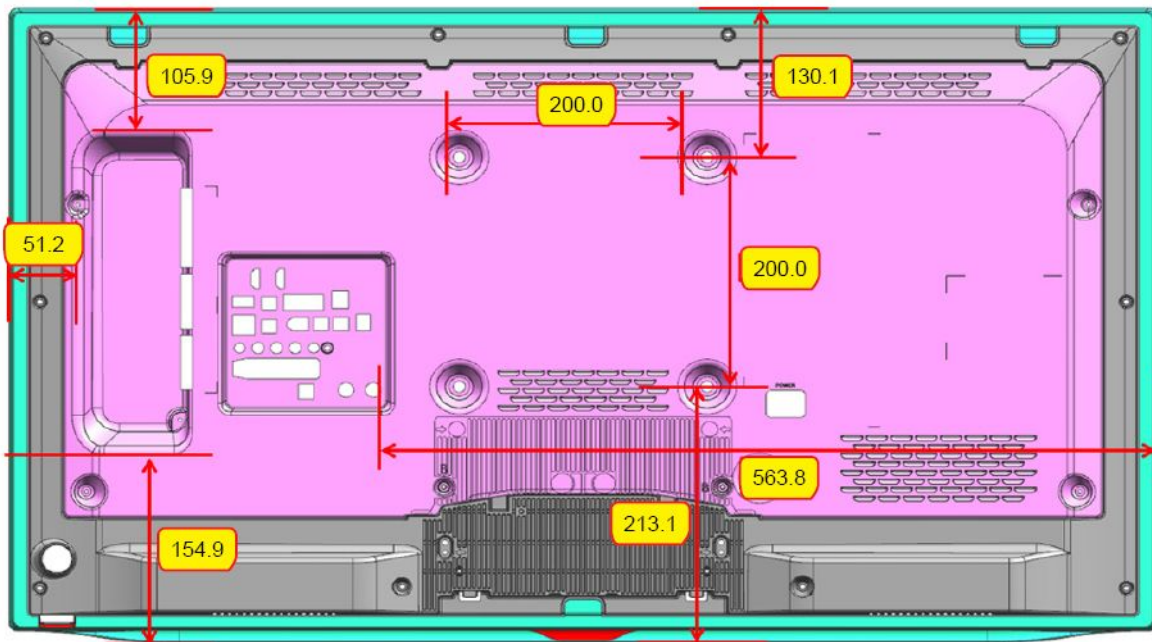

■ UE46ES55** (57**/58**)

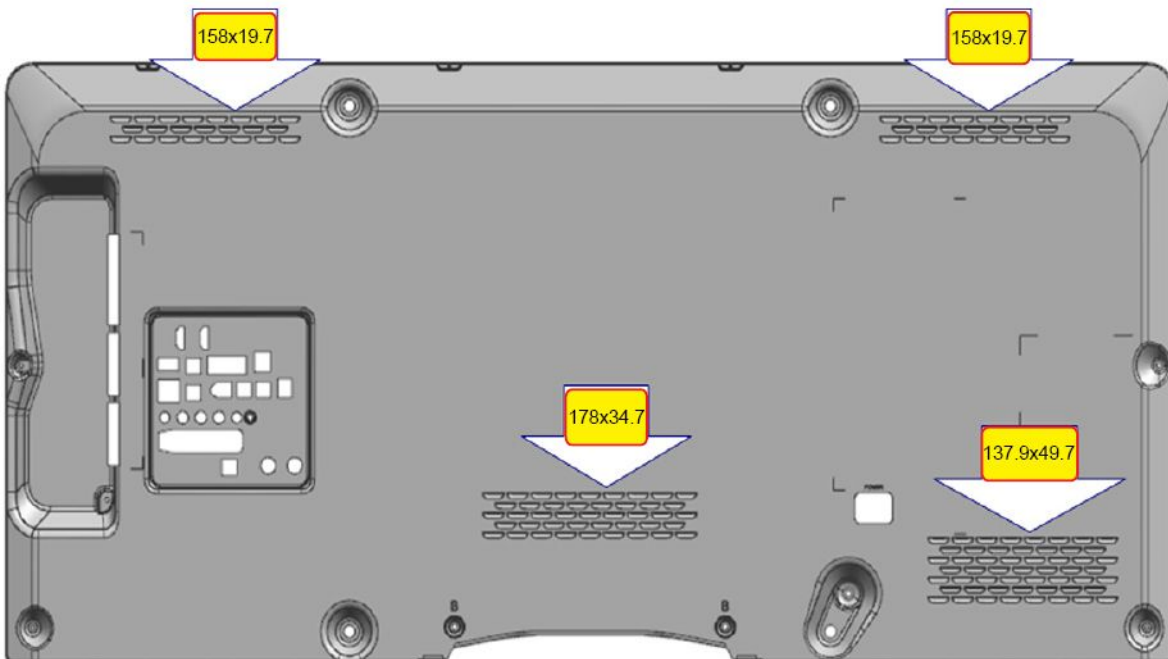
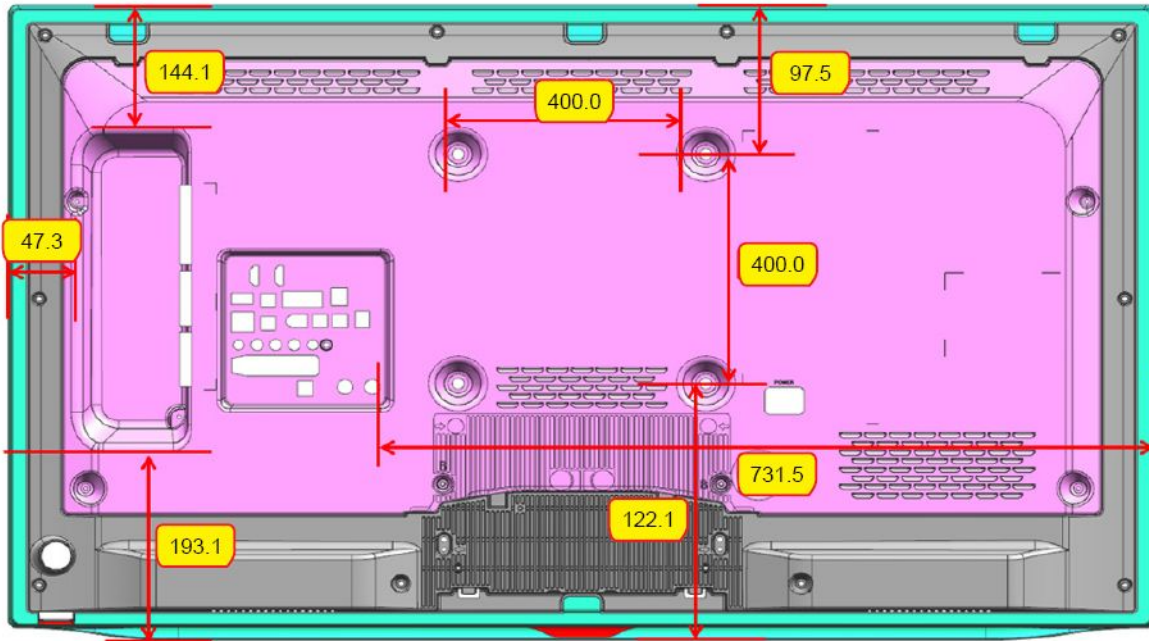

■ UE50ES55** (57**)

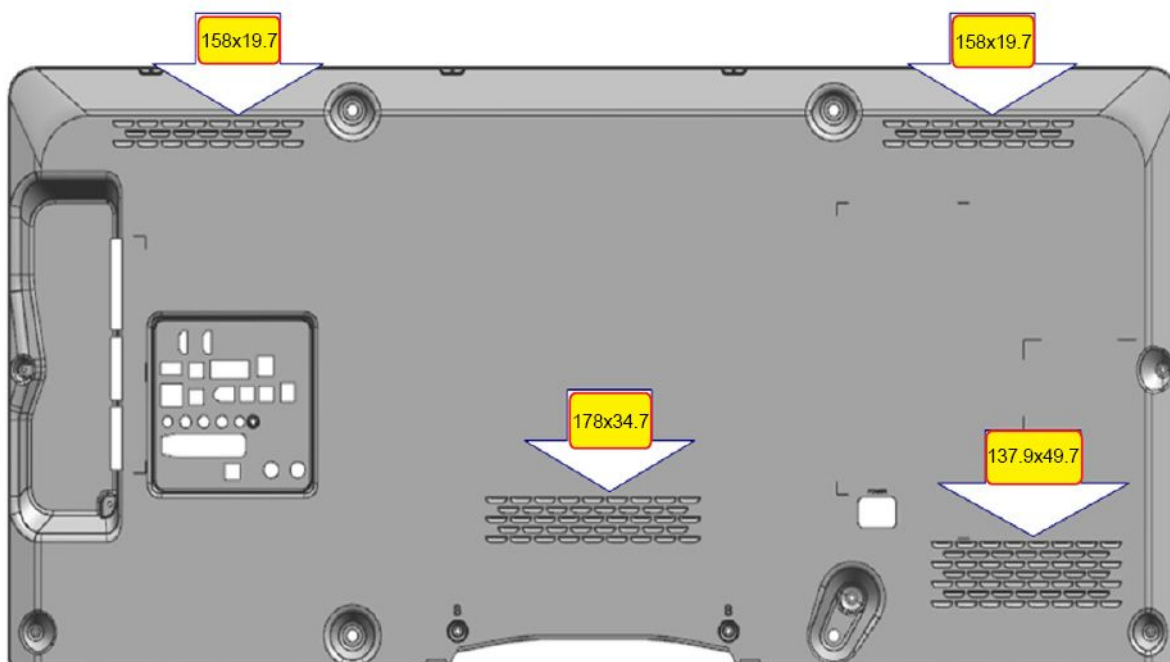
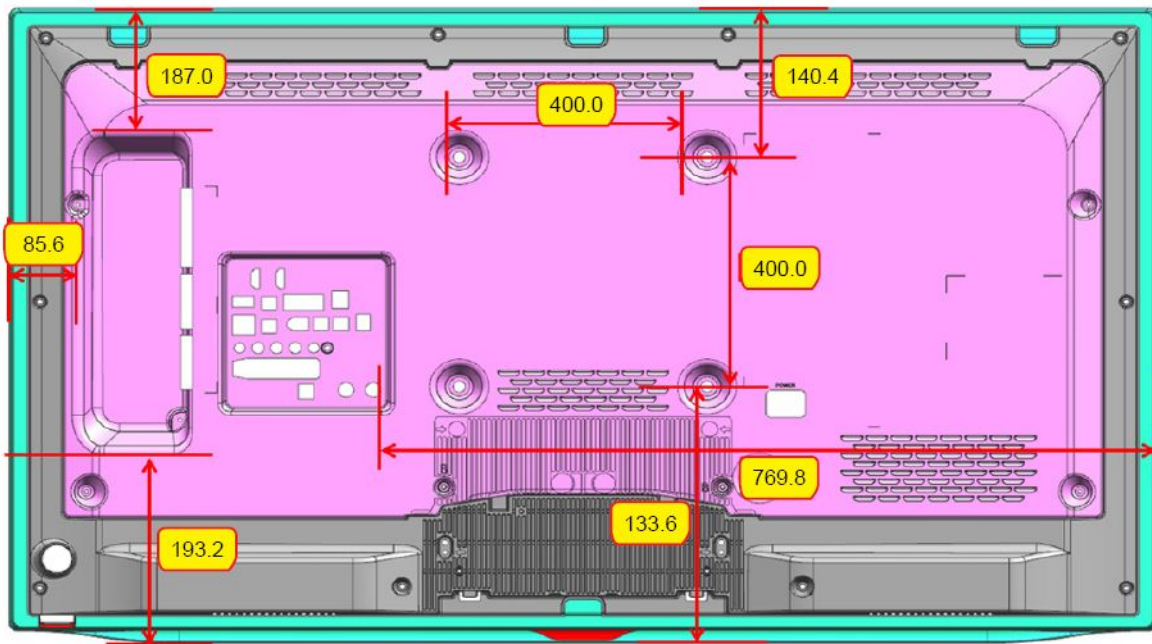

■ UE32EH53**/UE32EH5450W

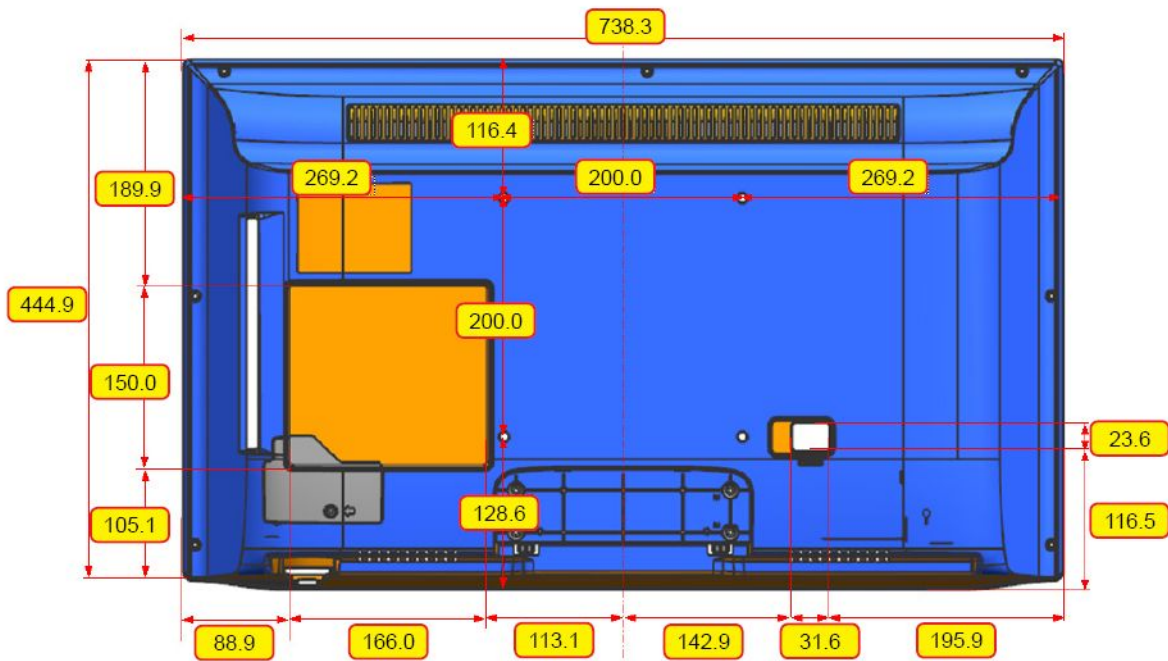

■ UE37EH53**

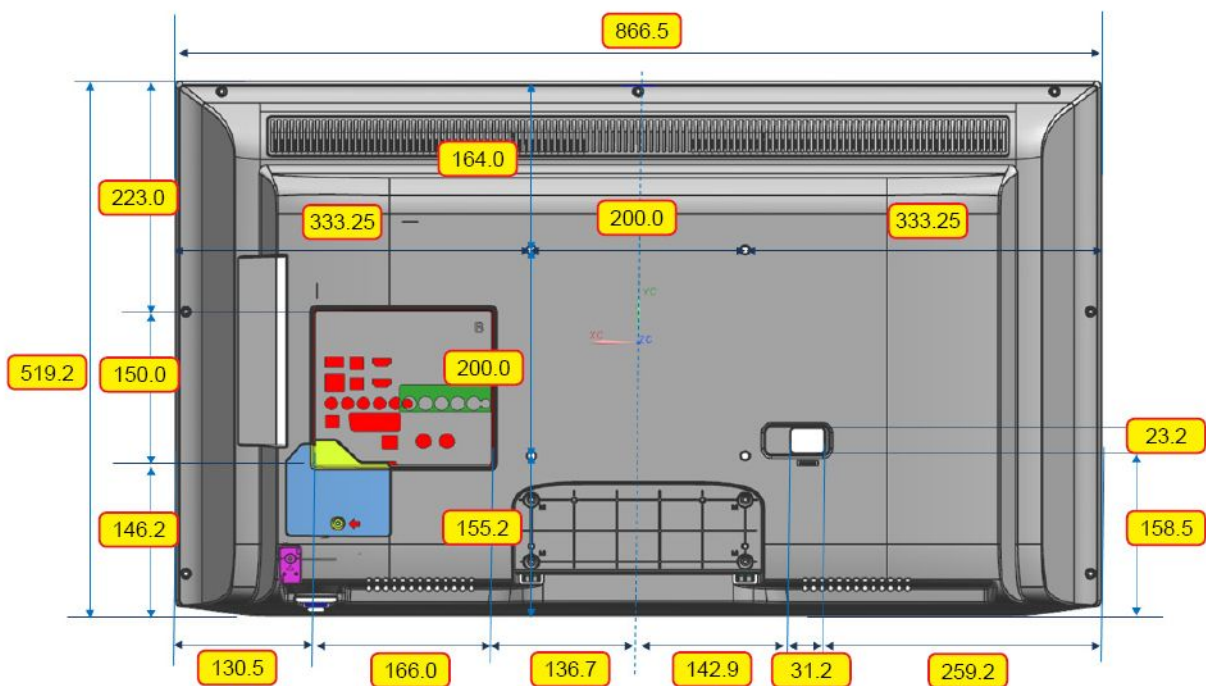

■ UE40EH53**/UE40EH5450W

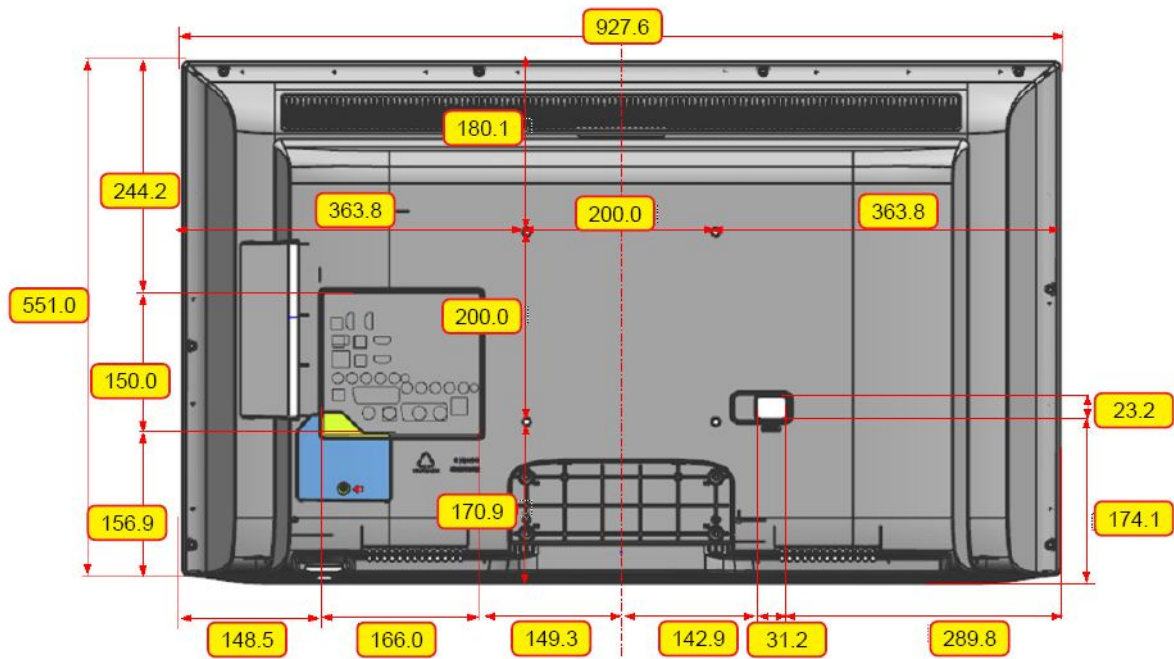

■ UE46EH53**/UE46EH5450W

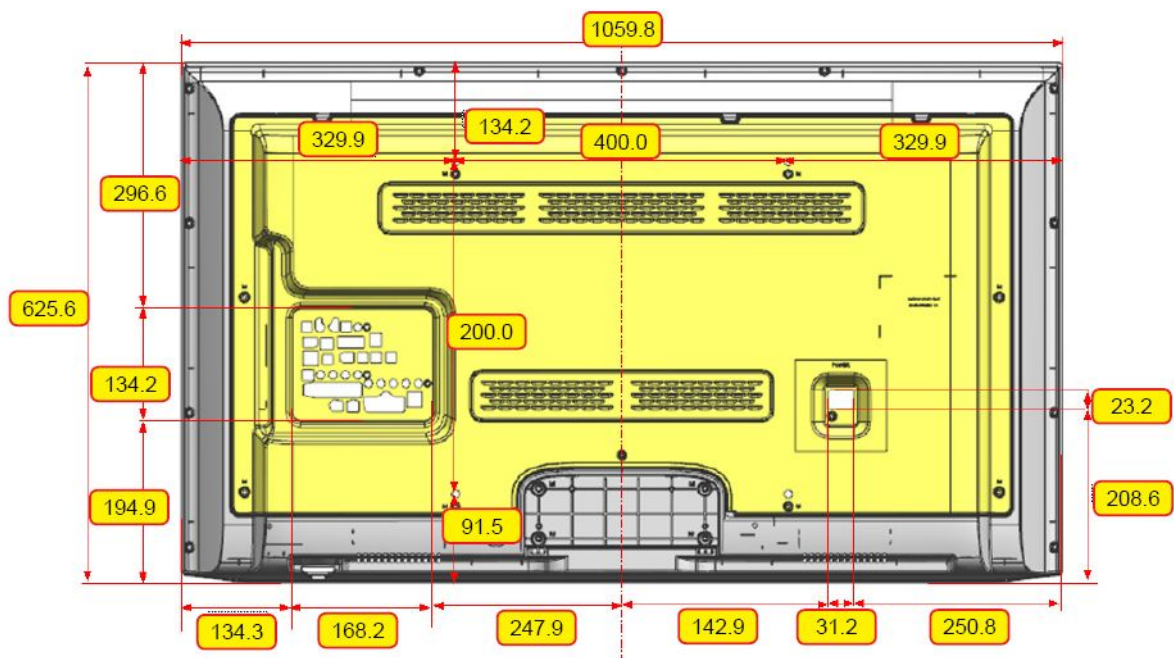

■ UE50EH53**

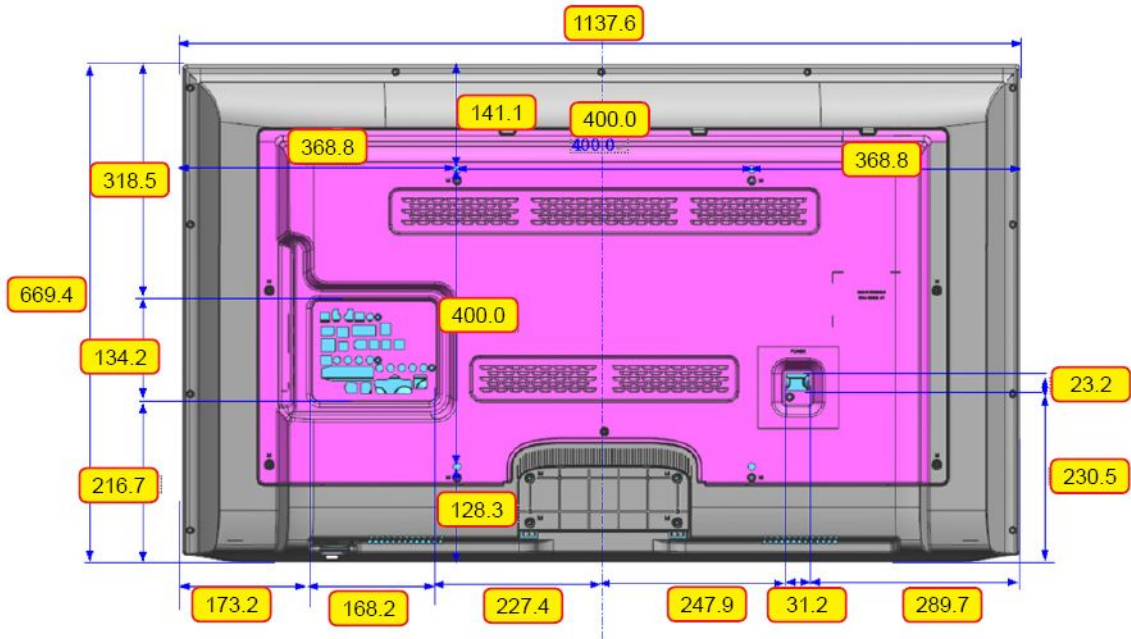

■ UE26EH45**

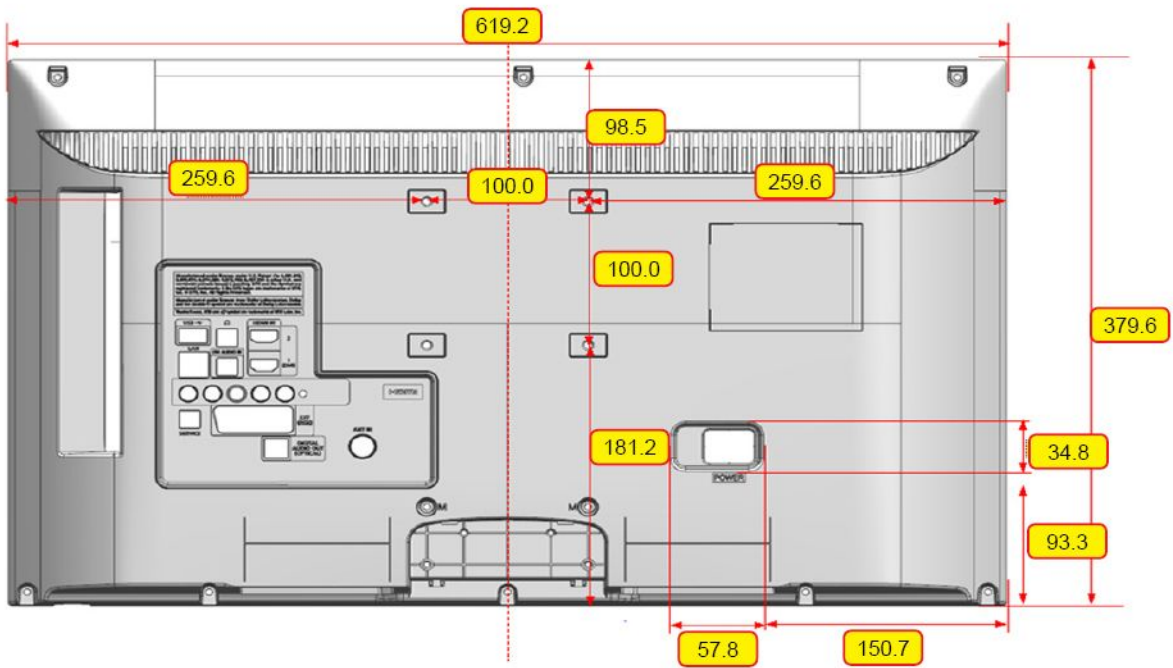



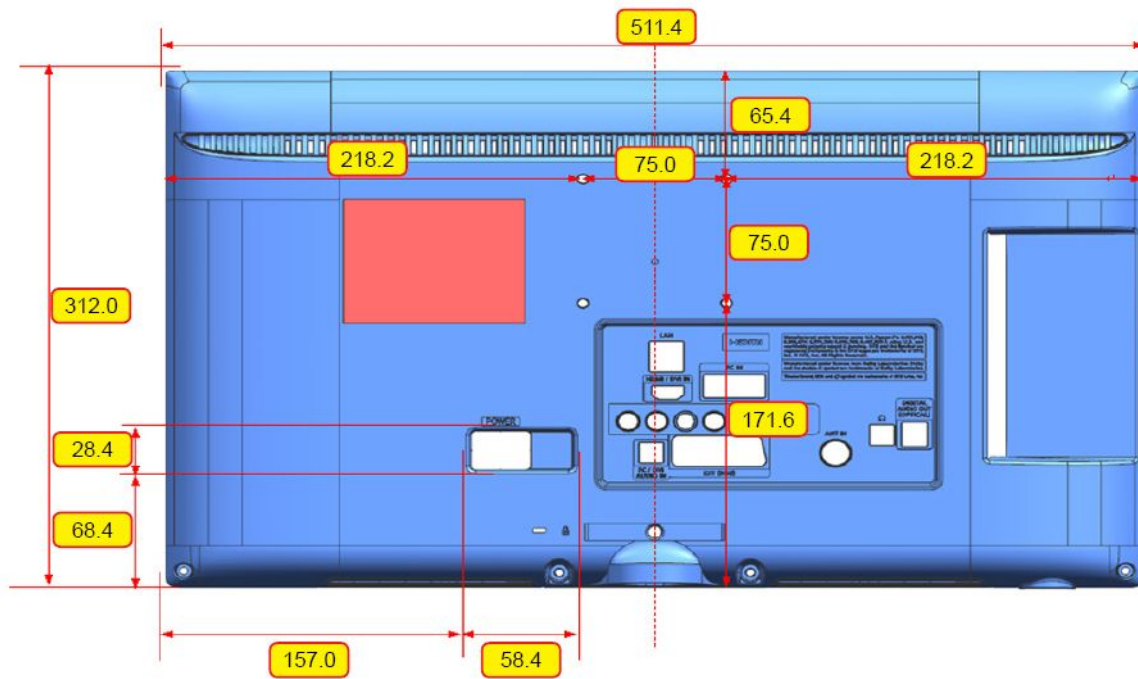











■ UE22EH54**







4.9. Service Item Code



■ 55**, 57**, 58**, 53**, 45**, 5450W

	ITEM	LOCATION	CODE	Picture View
1	HEADER-BOARD TO CABLE	CN201	3711-007742	
2	HEADER-BOARD TO CABLE	CN1401_FHD	3711-005925	
		CN1403_HD	3708-001150 -UE26EH45**WX** (Only)	
3	JACK-SCART	CN501_SC	3722-003408	
4	CONNECTOR-CARD SLOT	CN1601_CI	3709-001712	
5	JACK-PIN	CN502	3722-003213	
6	JACK-PONE	CN301 CN402 CN1203	3722-003226	

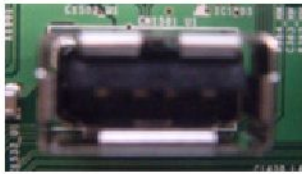

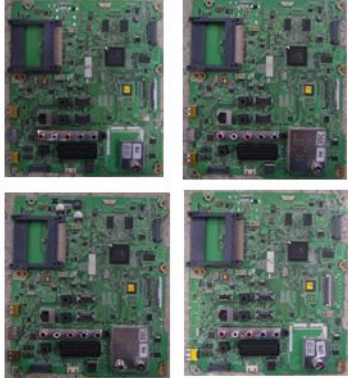

7	Tuner	TU701_HN	BN40-00232A (T/C) - UE**EH53**WX** - UE**EH53**PX** - UE**ES55**WX** - UE**ES55**PX** - UE26EH45**WX**	
		TU703_FN	BN40-00235A (T2/C) - UE**ES57**SX** - UE**ES57**QX** - UE**ES5800SX**	
		TU703_FN	BN40-00239B (T2/C) - UE**EH53**KX** - UE**ES55**KX**	
8	HEADER-BOARD TO CABLE	CN1201	3711-007571	
9	HEADER-BOARD TO CABLE	CN302	3711-008131	
10	JACK-MODULAR	CN1402_LAN	3722-003229	
11	HEADER-BOARD TO CABLE	CN1505_WIFI_S	3711-007814 - UE26EH45**WX** (Only)	

4. Troubleshooting

12	CONNECTOR-HDMI	CN601_H1 CN602_H2	3701-001784	
		CN603_H3	3701-001762 - UE26EH45**WX** (Not exist!!)	
13	JACK-USB	CN1502_U1	3722-003248 - UE26EH45**WX** (Only)	
		CN1502_U2 CN1502_U3	3722-003225 - UE26EH45**WX** (CN1502_U3 not exist!!)	
14	CONNECTOR-OPTICAL	OP301	3707-001106	

<p>15</p>	<p>ASSY PCB MAIN</p>	<p>-</p>	<p>UE32ES5500**** : BN94-05561X UE37ES5500**** : BN94-05562R UE40ES5500**** : BN94-05561Y UE46ES5500**** : BN94-05561Z UE50ES5500**** : BN94-05841H UE32ES5700**** : BN94-05562H UE37ES5700**** : BN94-05562J UE40ES5700**** : BN94-05562K UE46ES5700**** : BN94-05562P UE50ES5700**** : BN94-05841M UE32ES5800**** : BN94-05851Q UE40ES5800**** : BN94-05851R UE46ES5800**** : BN94-05851S UE32EH5300**** : BN94-05559E UE37EH5300**** : BN94-05731K UE40EH5300**** : BN94-05559F UE46ES5300**** : BN94-05559G UE50EH5300**** : BN94-05731F UE26EH4500**** : BN94-05684Q</p>	
<p>16</p>	<p>SMPS</p>	<p>-</p>	<p>UE32ES5500(5700)**** : BN44-00501A UE40ES5500(5700)**** : BN44-00502A UE46ES5500(5700)**** : BN44-00502A UE32EH5300**** : BN44-00493B UE40EH5300**** : BN44-00498A UE46ES5300**** : BN44-00498A UE26EH4500**** : BN44-00491A</p>	







4. Troubleshooting

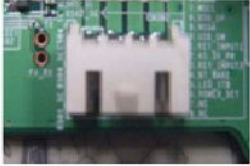

17	ASSY BOARD P-5WAY SWITCH FUNCTION	-	UE32ES5500(5700,5800)**** : BN96-22457N UE37ES5500(5700)**** : BN96-22457P UE40ES5500(5700,5800)**** : BN96-22457P UE46ES5500(5700,5800)**** : BN96-22457Q UE50ES5500(5700)**** : BN96-22457Q	
		-	UE32EH5300**** : BN96-22457K UE37EH5300**** : BN96-22413T UE40EH5300**** : BN96-22413J UE46EH5300**** : BN96-22413H UE50EH5300**** : BN96- 22413N	
		-	UE26EH4500**** : BN96-22877B	
18	WIFI MODULE	-	BN59-01148A - UE26EH4500**** UE22ES5400****	

■ E54**

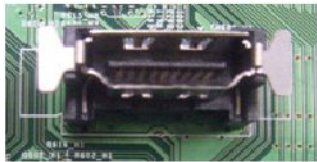
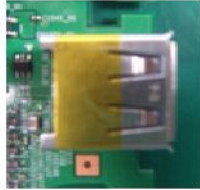
	ITEM	LOCATION	CODE	Picture View
1	HEADER-BOARD TO CABLE	CN202	3711-007741	
2	HEADER-BOARD TO CABLE	CN1401	3711-005925	
3	JACK-SCART	CN501_SC	3722-003408	
4	CONNECTOR-CARD SLOT	CN1601_CI	3709-001712	
5	JACK-PIN	CN502	3722-003213	
6	JACK-PONE	CN301_HP CN402	3722-003226	
7	Tuner	TU701_HN	BN40-00232A (T/C)	
8	HEADER-BOARD TO CABLE	CN1202	3711-007571	

4. Troubleshooting

9	HEADER-BOARD TO CABLE	CN302	3711-008131	
10	CONNECTOR-DSUB	CN1601	3701-001746	
11	HEADER-BOARD TO CABLE	CN1504_WIFI	3711-007814	
12	JACK-MODULAR	CN1402_LAN	3722-003229	
13	CONNECTOR-HDMI	CN601_H1 CN602_H2	3701-001784	
14	JACK-USB	CN1501_U1 CN1502_U2	3722-003225	
15	CONNECTOR-OPTICAL	OP301	3707-001106	
16	ASSY PCB MAIN	-	BN94-05679T	

17	SMPS	-	BN44-00504A	
18	ASSY BOARD P-5WAY SWITCH FUNCTION	-	BN96-22880B	
19	WIFI MODULE	-	BN59-01148A	

5. Wiring Diagram

5.1. Wiring Diagram

■ E53**, E55**, E57**, E58**, E5450W

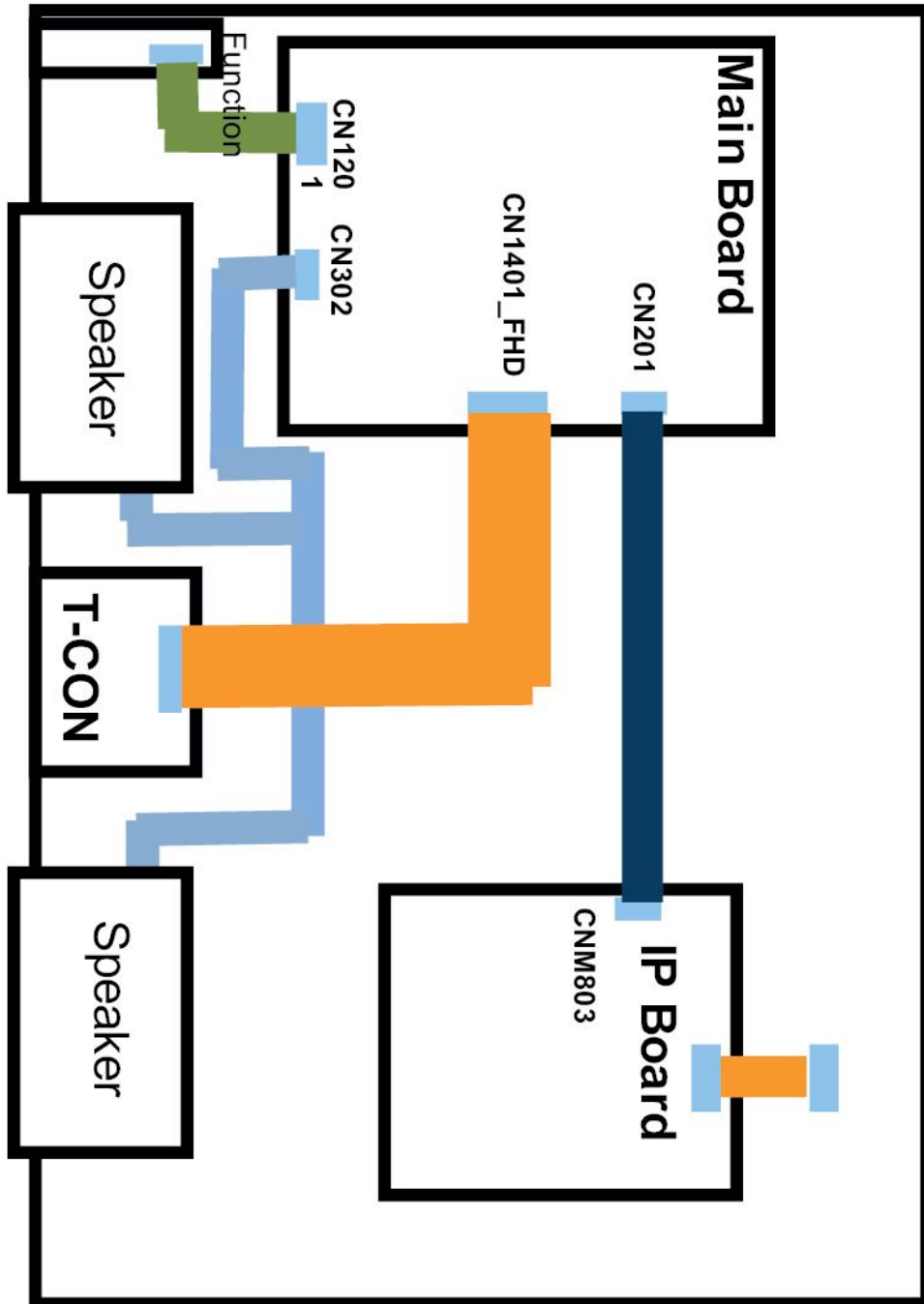

■ E45**

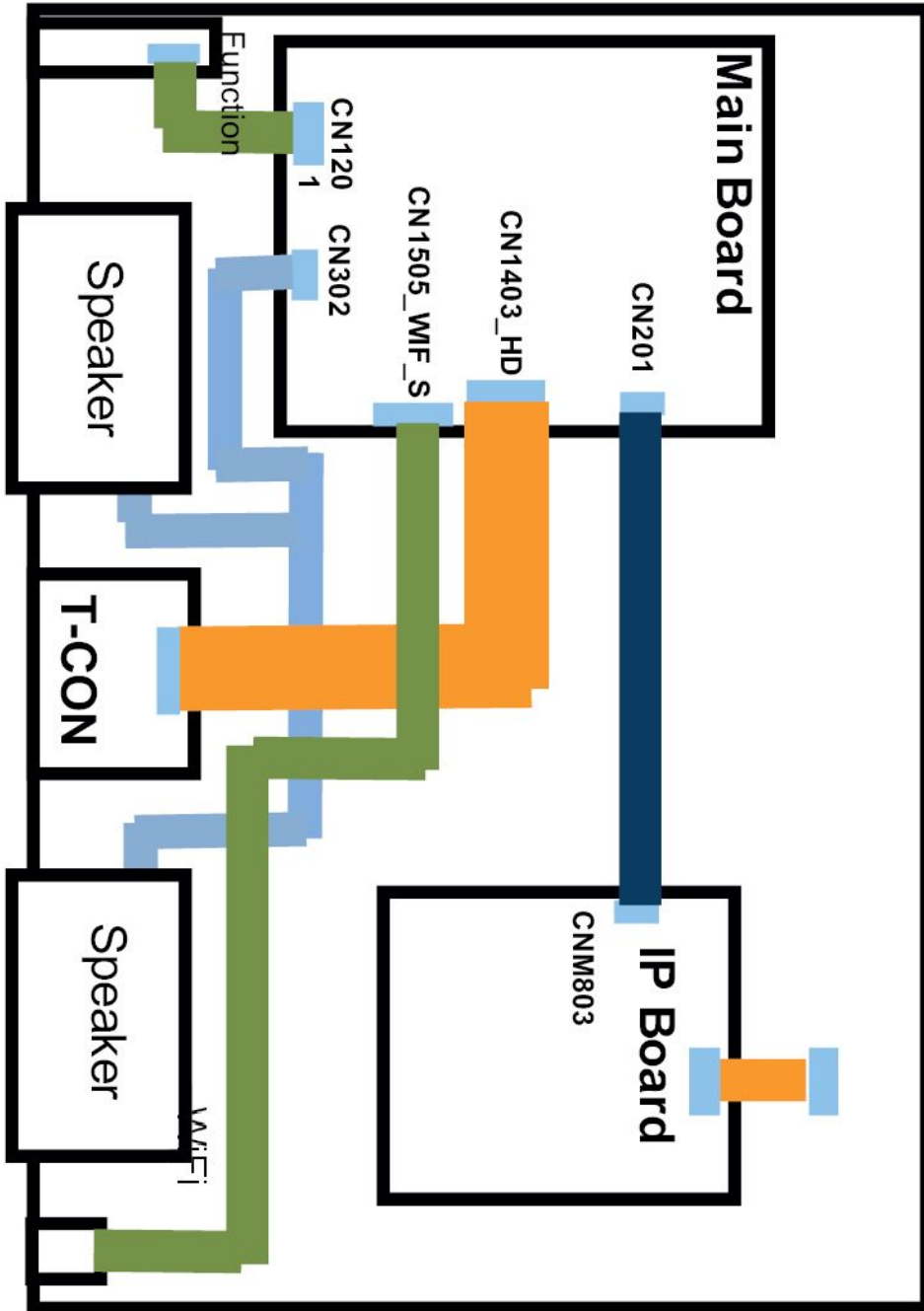

■ E54**

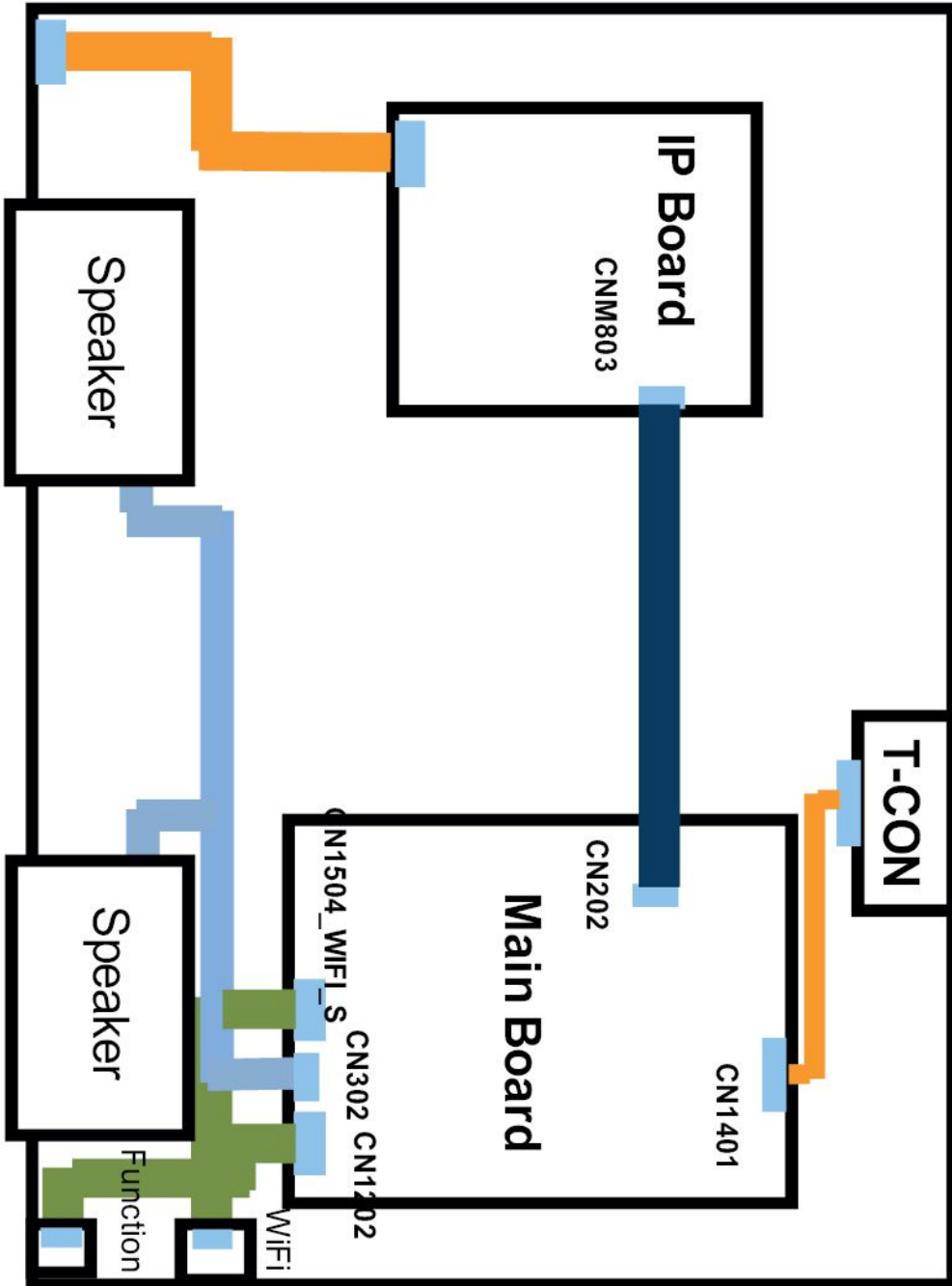

5.2. Connector

■ Main Board (E55**, E57**, E58**, E53**, E45**, E5450W)

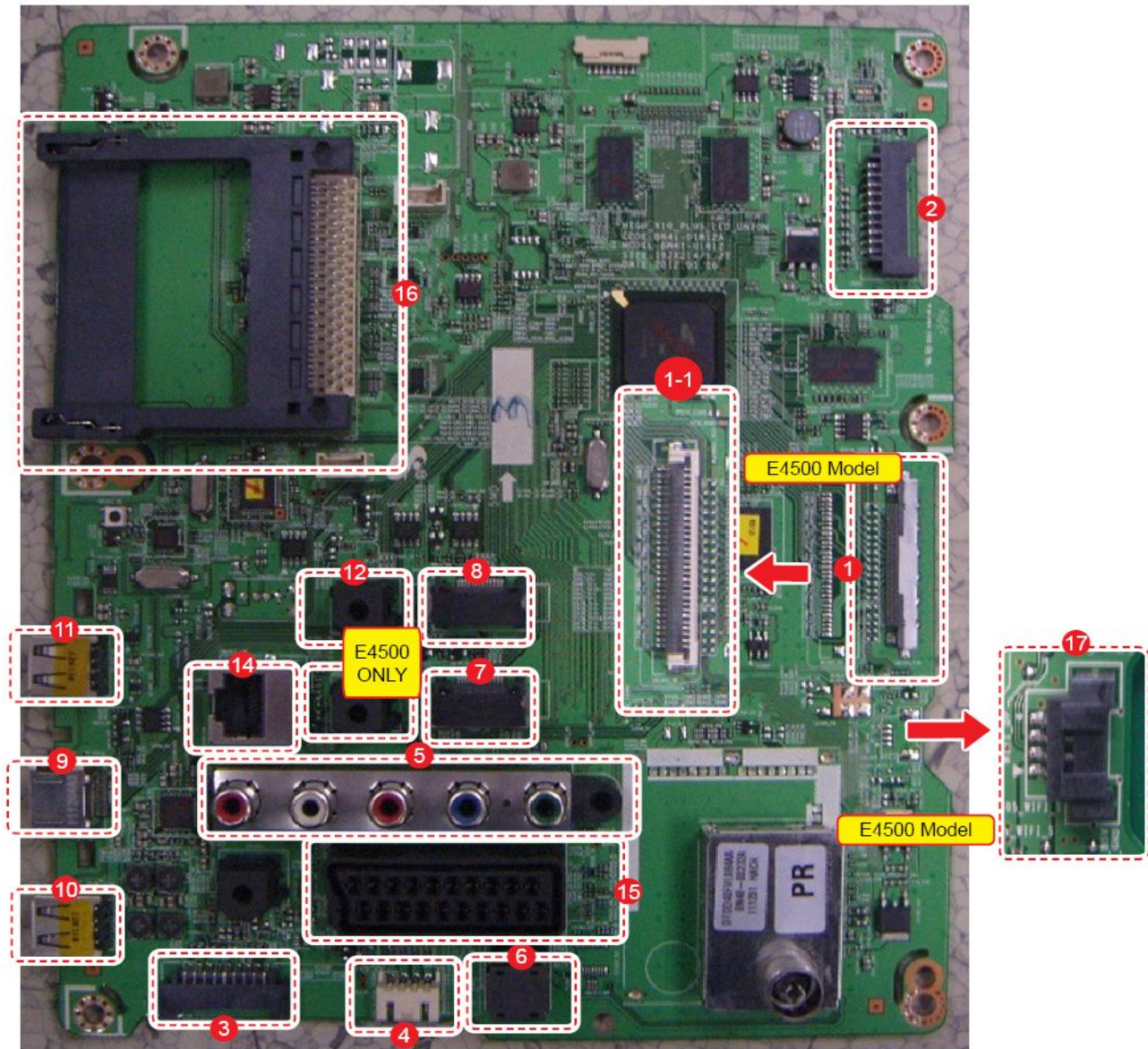

① CN1401_FHD			
1	NC	11	NC
2	GND	12	TCON_SCL
3	NC	13	GND
4	NC	14	EVEN_TX4+_LVDS
5	NC	15	EVEN_TX4-_LVDS
6	NC	16	EVEN_TX3+_LVDS
7	GND	17	EVEN_TX3-_LVDS
8	TCON_SDA	18	GND
9	PANEL_I2C_EN	19	EVEN_TXCLK+_LVDS
10	NC	20	EVEN_TXCLK-_LVDS

① CN1401_FHD			
21	GND	31	ODD_TX3+_LVDS
22	EVEN_TX2+_LVDS	32	ODD_TX3-_LVDS
23	EVEN_TX2-_LVDS	33	GND
24	EVEN_TX1+_LVDS	34	ODD_TXCLK+_LVDS
25	EVEN_TX1-_LVDS	35	ODD_TXCLK-_LVDS
26	EVEN_TX0+_LVDS	36	GND
27	EVEN_TX0-_LVDS	37	ODD_TX2+_LVDS
28	GND	38	ODD_TX2-_LVDS
29	ODD_TX4+_LVDS	39	ODD_TX1+_LVDS
30	ODD_TX4-_LVDS	40	ODD_TX1-_LVDS

① CN1401_FHD			
41	ODD_TX0+_LVDS	47	Panel_13V_PW
42	ODD_TX0-_LVDS	48	Panel_13V_PW
43	GND	49	Panel_13V_PW
44	GND	50	Panel_13V_PW
45	GND	51	Panel_13V_PW
46	NC		

①-1 CN1403_HD (E4500 Only)			
1	PANEL_13V	16	EVEN_TXCLK+_LVDS
2	PANEL_13V	17	EVEN_TXCLK-_LVDS
3	PANEL_13V	18	GND
4	PANEL_13V	19	EVEN_TX2+_LVDS
5	PANEL_13V	20	EVEN_TX2-_LVDS
6	GND	21	GND
7	GND	22	EVEN_TX1+_LVDS
8	GND	23	EVEN_TX1-_LVDS
9	PANEL_I2C_EN	24	GND
10	NC	25	EVEN_TX0+_LVDS
11	NC	26	EVEN_TX0-_LVDS
12	GND	27	GND
13	EVEN_TX3+_LVDS	28	TCON_SDA
14	EVEN_TX3-_LVDS	29	TCON_SCL
15	GND	30	NC

② CN201 (to Power board)			
1	B5.3V	11	B13V
2	SW_PW	12	B13V
3	B5.3V	13	B13V
4	A5.3V	14	PWM_DIM
5	GND	15	NC
6	GND	16	NC
7	B12VS	17	NC
8	GND	18	NC
9	B12VS	19	NC
10	SW_INV	20	NC

③ CN1201 (FUNCTION)			
1	IR	10	NC
2	NC	11	KEY_INPUT1
3	GND	12	NC
4	NC	13	KEY_INPUT2
5	A3.3V	14	NC
6	NC	15	A3.3V
7	MSCL	16	NC
8	NC	17	NC
9	MSDA	18	NC

④ CN302 (SPEAKER)			
1	R+	3	L+
2	R-	4	L-

⑤ CN502 (COMPONENT)			
1	GND	9	COMP2_PR
2	COMP2_Y_CVBS	10	GND
3	IDENT_VIDEO2	11	COMP2_AV2_SL_IN
4	GND	12	COMP2_AV2_SR_IN
5	COMP2_PB	13	GND
6	IDENT_COMP2	14	COMP2_AV2_SR_IN
7	GND	15	COMP2_AV2_SL_IN
8	COMP2_PR		

⑥ OP301 (OPTICAL)			
1	SPDIF_OUT	3	GND
2	B5V_DC_PW		

⑦ CN601_H1 (HDMI1)			
1	HDMI1_RX2+	11	GND
2	GND	12	HDMI1_RXCLK-
3	HDMI1_RX2-	13	CEC
4	HDMI1_RX1+	14	NC
5	GND	15	HDMI1_SCL_DDC
6	HDMI1_RX1-	16	HDMI1_SDA_DDC
7	HDMI1_RX0+	17	GND
8	GND	18	IDENT_HDMI1
9	HDMI1_RX0-	19	HDMI1_HOT_PLUG
10	HDMI1_RXCLK+		

8 CN602_H2 (HDMI2)			
1	HDMI2_RX2+	11	GND
2	GND	12	HDMI2_RXCLK-
3	HDMI2_RX2-	13	CEC
4	HDMI2_RX1+	14	NC
5	GND	15	HDMI2_SCL_DDC
6	HDMI2_RX1-	16	HDMI2_SDA_DDC
7	HDMI2_RX0+	17	GND
8	GND	18	IDENT_HDMI2
9	HDMI2_RX0-	19	HDMI2_HOT_PLUG
10	HDMI2_RXCLK+		

9 CN603_H3 (HDMI3)_E4500 not exist			
1	HDMI3_RX2+	11	GND
2	GND	12	HDMI3_RXCLK-
3	HDMI3_RX2-	13	CEC
4	HDMI3_RX1+	14	NC
5	GND	15	HDMI3_SCL_DDC
6	HDMI3_RX1-	16	HDMI3_SDA_DDC
7	HDMI3_RX0+	17	GND
8	GND	18	IDENT_HDMI3
9	HDMI3_RX0-	19	HDMI3_HOT_PLUG
10	HDMI3_RXCLK+		

10 CN1502_U2 (USB2)			
1	B5V_USB2_PW	3	USB2_DP
2	USB2_DM	4	GND

11 CN1503_U3 (USB3)_E4500 not exist			
1	B5V_USB3_PW	3	USB3_DP
2	USB3_DM	4	GND

11-1 CN1502_U1 (USB1) E4500 Only			
1	B5V_USB1_PW	3	USB1_DP
2	USB1_DM	4	GND

12 CN301(HEADPHONE&LR OUT)			
1	GND	4	GND
2	HP_SR_OUT	5	IDENT_HP
3	HP_SL_OUT	6	GND

13 CN402 (DVI_AUDIO)			
1	DVI_SR_IN	4	NC
2	DVI_SL_IN	5	NC
3	NC	6	NC

14 CN1402 (LAN)			
1	LAN_TXD+	5	B2.5V_PW
2	B2.5V_PW	6	LAN_RXD-
3	LAN_TXD-	7	NC
4	LAN_RXD+	8	GND

15 CN501 (SCART)			
1	SC_SR_OUT	12	NC
2	SC_SR_IN	13	GND
3	SC_SL_OUT	14	GND
4	GND	15	SC_R
5	GND	16	SC_FB
6	SC_SL_IN	17	GND
7	SC_B	18	GND
8	IDENT_SC	19	SC_CVBS_OUT
9	GND	20	SC_CVBS_IN
10	NC	21	GND
11	SC_G		

16 CN1601_CI (PCMCIA)			
1	GND	23	EXT_ADDR[6]
2	EXT_DATA[3]	24	EXT_ADDR[5]
3	EXT_DATA[4]	25	EXT_ADDR[4]
4	EXT_DATA[5]	26	EXT_ADDR[3]
5	EXT_DATA[6]	27	EXT_ADDR[2]
6	EXT_DATA[7]	28	EXT_ADDR[1]
7	PCM_CE1	29	EXT_ADDR[0]
8	EXT_ADDR[10]	30	EXT_DATA[0]
9	PCM_OE	31	EXT_DATA[1]
10	EXT_ADDR[11]	32	EXT_DATA[2]
11	EXT_ADDR[9]	33	CI_VCC
12	EXT_ADDR[8]	34	GND
13	EXT_ADDR[13]	35	GND
14	EXT_ADDR[14]	36	PCM_CD1
15	PCM_WE	37	TSO_DATA[3]
16	PCM_IRQA	38	TSO_DATA[4]
17	CI_VCC	39	TSO_DATA[5]
18	CI_VCC	40	TSO_DATA[6]
19	CH_VALID	41	TSO_DATA[7]
20	CH_CLK	42	PCM_CE2
21	EXT_ADDR[12]	43	NC
22	EXT_ADDR[7]	44	PCM_IORD

16 CN1601_CI (PCMCIA)			
45	PCM_IOWR	57	TSO_CLK
46	CH_START	58	PCM_RESET
47	CH_DATA[0]	59	PCM_WAIT
48	CH_DATA[1]	60	NC
49	CH_DATA[2]	61	PCM_REG
50	CH_DATA[3]	62	TSO_VALID
51	CI_VCC	63	TSO_START
52	CI_VCC	64	TSO_DATA[0]
53	CH_DATA[4]	65	TSO_DATA[1]
54	CH_DATA[5]	66	TSO_DATA[2]
55	CH_DATA[6]	67	GND
56	CH_DATA[7]	68	GND

17 CN1505_WIFI_S_E4500 Only			
1	B5V_DC_PW	3	WIFI_DP
2	WIFI_DM	4	GND

■ Main Board (E54**)

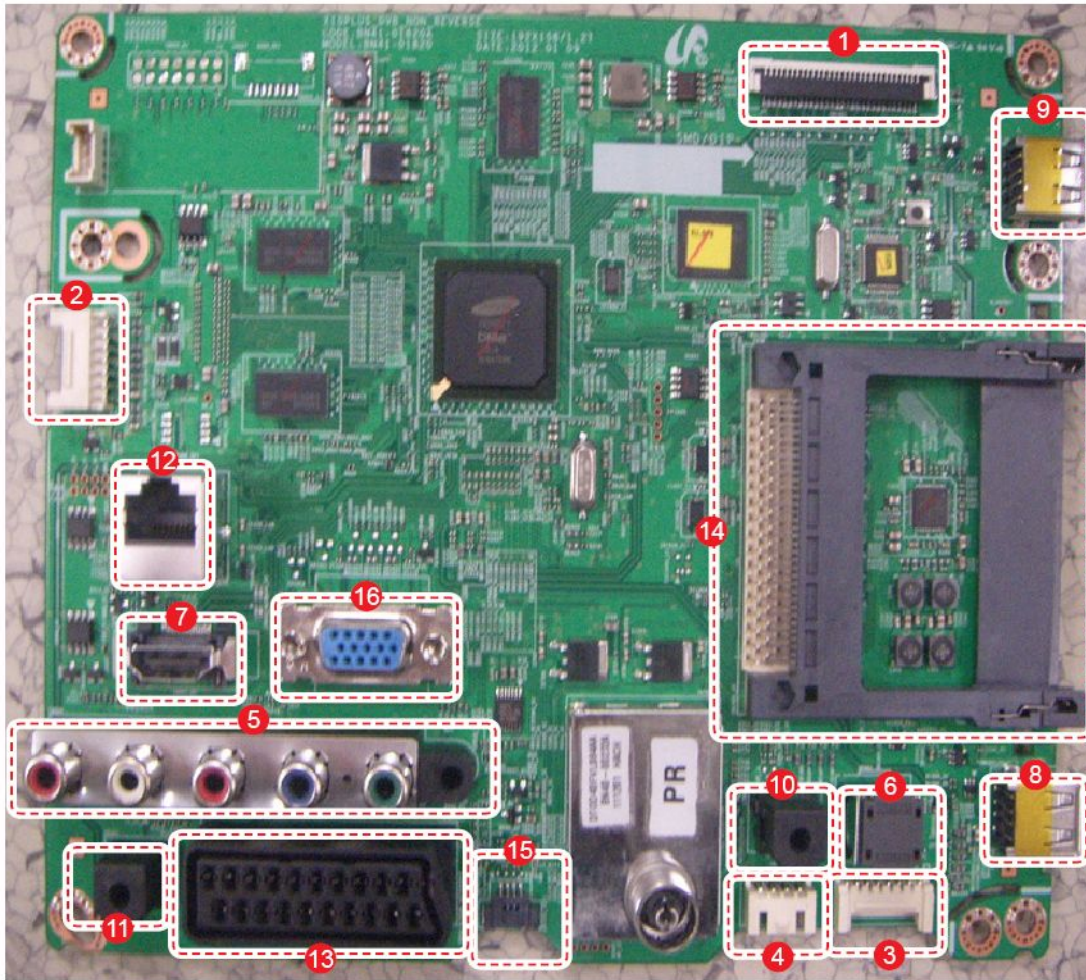

① CN1401			
1	PANEL_13V	16	EVEN_TXCLK+_LVDS
2	PANEL_13V	17	EVEN_TXCLK-_LVDS
3	PANEL_13V	18	GND
4	PANEL_13V	19	EVEN_TX2+_LVDS
5	PANEL_13V	20	EVEN_TX2-_LVDS
6	GND	21	GND
7	GND	22	EVEN_TX1+_LVDS
8	GND	23	EVEN_TX1-_LVDS
9	PANEL_I2C_EN	24	GND
10	NC	25	EVEN_TX0+_LVDS
11	NC	26	EVEN_TX0-_LVDS
12	GND	27	GND
13	EVEN_TX3+_LVDS	28	TCON_SDA
14	EVEN_TX3-_LVDS	29	TCON_SCL
15	GND	30	NC

② CN202 (to Power board)			
1	B5.3V	8	GND
2	SW_PW	9	B12VS
3	B5.3V	10	SW_INV
4	A5.3V	11	B13V
5	GND	12	B13V
6	GND	13	B13V
7	B12VS	14	PWM_DIM

③ CN1202 (FUNCTION)			
1	IR	5	MSDA
2	GND	6	KEY_INPUT1
3	A3.3V	7	KEY_INPUT2
4	MSCL	8	A3.3V

④ CN302 (SPEAKER)			
1	R+	3	L+
2	R-	4	L-

⑤ CN502 (COMPONETN)			
1	GND	9	COMP2_PR
2	COMP2_Y_CVBS	10	GND
3	IDENT_VIDEO2	11	COMP2_AV2_SL_IN
4	GND	12	COMP2_AV2_SR_IN
5	COMP2_PB	13	GND
6	IDENT_COMP2	14	COMP2_AV2_SR_IN
7	GND	15	COMP2_AV2_SL_IN
8	COMP2_PR		

⑥ OP301 (OPTICAL)			
1	SPDIF_OUT	3	GND
2	B5V_DC_PW		

⑦ CN601_H1 (HDMI1)			
1	HDMI1_RX2+	11	GND
2	GND	12	HDMI1_RXCLK-
3	HDMI1_RX2-	13	CEC
4	HDMI1_RX1+	14	NC
5	GND	15	HDMI1_SCL_DDC
6	HDMI1_RX1-	16	HDMI1_SDA_DDC
7	HDMI1_RX0+	17	GND
8	GND	18	IDENT_HDMI1
9	HDMI1_RX0-	19	HDMI1_HOT_PLUG
10	HDMI1_RXCLK+		

⑧ CN1502_U1 (USB1)			
1	B5V_USB1_PW	3	USB1_DP
2	USB1_DM	4	GND

⑨ CN1502_U2 (USB2)			
1	B5V_USB2_PW	3	USB2_DP
2	USB2_DM	4	GND

⑩ CN301_HP (HEADPHONE&LR OUT)			
1	GND	4	GND
2	HP_SR_OUT	5	IDENT_HP
3	HP_SL_OUT	6	GND

⑪ CN402 (DVI_AUDIO)			
1	DVI_SR_IN	4	NC
2	DVI_SL_IN	5	NC
3	NC	6	NC

⑫ CN1402_LAN			
1	LAN_TXD+	5	B2.5V_PW
2	B2.5V_PW	6	LAN_RXD-
3	LAN_TXD-	7	NC
4	LAN_RXD+	8	GND

⑬ CN501 (SCART)			
1	SC_SR_OUT	12	NC
2	SC_SR_IN	13	GND
3	SC_SL_OUT	14	GND
4	GND	15	SC_R
5	GND	16	SC_FB
6	SC_SL_IN	17	GND
7	SC_B	18	GND
8	IDENT_SC	19	SC_CVBS_OUT
9	GND	20	SC_CVBS_IN
10	NC	21	GND
11	SC_G		

⑭ CN1601_CI (PCMCIA)			
1	GND	23	EXT_ADDR[6]
2	EXT_DATA[3]	24	EXT_ADDR[5]
3	EXT_DATA[4]	25	EXT_ADDR[4]
4	EXT_DATA[5]	26	EXT_ADDR[3]
5	EXT_DATA[6]	27	EXT_ADDR[2]
6	EXT_DATA[7]	28	EXT_ADDR[1]
7	PCM_CE1	29	EXT_ADDR[0]
8	EXT_ADDR[10]	30	EXT_DATA[0]
9	PCM_OE	31	EXT_DATA[1]
10	EXT_ADDR[11]	32	EXT_DATA[2]
11	EXT_ADDR[9]	33	CI_VCC
12	EXT_ADDR[8]	34	GND
13	EXT_ADDR[13]	35	GND
14	EXT_ADDR[14]	36	PCM_CD1
15	PCM_WE	37	TSO_DATA[3]
16	PCM_IRQA	38	TSO_DATA[4]
17	CI_VCC	39	TSO_DATA[5]
18	CI_VCC	40	TSO_DATA[6]
19	CH_VALID	41	TSO_DATA[7]
20	CH_CLK	42	PCM_CE2
21	EXT_ADDR[12]	43	NC
22	EXT_ADDR[7]	44	PCM_IORD

14 CN1601_CI (PCMCIA)			
45	PCM_IOWR	57	TSO_CLK
46	CH_START	58	PCM_RESET
47	CH_DATA[0]	59	PCM_WAIT
48	CH_DATA[1]	60	NC
49	CH_DATA[2]	61	PCM_REG
50	CH_DATA[3]	62	TSO_VALID
51	CI_VCC	63	TSO_START
52	CI_VCC	64	TSO_DATA[0]
53	CH_DATA[4]	65	TSO_DATA[1]
54	CH_DATA[5]	66	TSO_DATA[2]
55	CH_DATA[6]	67	GND
56	CH_DATA[7]	68	GND

15 CN1504_WIFI			
1	B5V_DC_PW	3	WIFI_DP
2	WIFI_DM	4	GND

16 CN1601 (D-SUB)			
1	PC RED+	9	PC_5V
2	PC GREEN+	10	IDENT_PC
3	PC_BLUE+	11	RDB_FANET_PC
4	TDB_FANET_PC	12	DSDA
5	GND	13	H_SYNC
6	PC RED-	14	V_SINC
7	PC GREEN-	15	DDC_WP
8	PC_BLUE-		

5.3. Connector Functions

Connector	Function
CN201 <-> Power CN	Supply main power and dimming signal from Power board to Main Board.
CN1401_FHD <-> T-CON CNF1	The LVDS signal transfered from Main Board to Panel .
CN1505_WIFI_S <-> WIFI MODULE	The Wifi signal signal transfered from Module to Main Board . <E4500, E5400 Only>

5.4. Cables

Use	LEAD (Main - SMPS)	LVDS CALBE (Main - panel)	Wifi CALBE (Main - Wifi Module)
Code No.	UE32ES55**(57**,58**) : BN39-01652H UE37ES55**(57**): BN39-01652J UE40ES55**(57**,58**): BN39-01652G UE46ES55**(57**,58**): BN39-01652D UE50ES5500**(57**): BN39-01652D UE32EH53**, UE32EH5450W : BN39-01652A UE37EH53** : BN39-01652B UE40EH53**, UE40EH5450W : BN39-01652B UE46EH53**, UE46EH5450W : BN39-01652C UE46EH53** : BN39-01652C UE26EH45** : BN39-01652F	UE32ES55**(57**,58**): BN96-17116E UE37ES55**(57**): BN96-22239S UE40ES55**(57**,58**): BN96-17116F UE46ES55**(57**,58**): BN96-17116G UE50ES55**(57**): BN96-22239Y UE32EH53**, UE32EH5450W : BN96-17116E UE37EH53** : BN96-23839G UE40EH53**, UE40EH5450W : BN96-22239P UE46EH53**, UE46EH5450W : BN96-22239Q UE50EH53** : BN96-22239W	UE26EH45** : BN39-01646F UE22ES54** : BN39-01646G
Image			
	UE22ES54** : BN39-01449T	UE22ES54** : BN96-20370P	
			
	UE26EH45** : BN96-20370R		
			

1. Exploded View & Part List

Exploded View

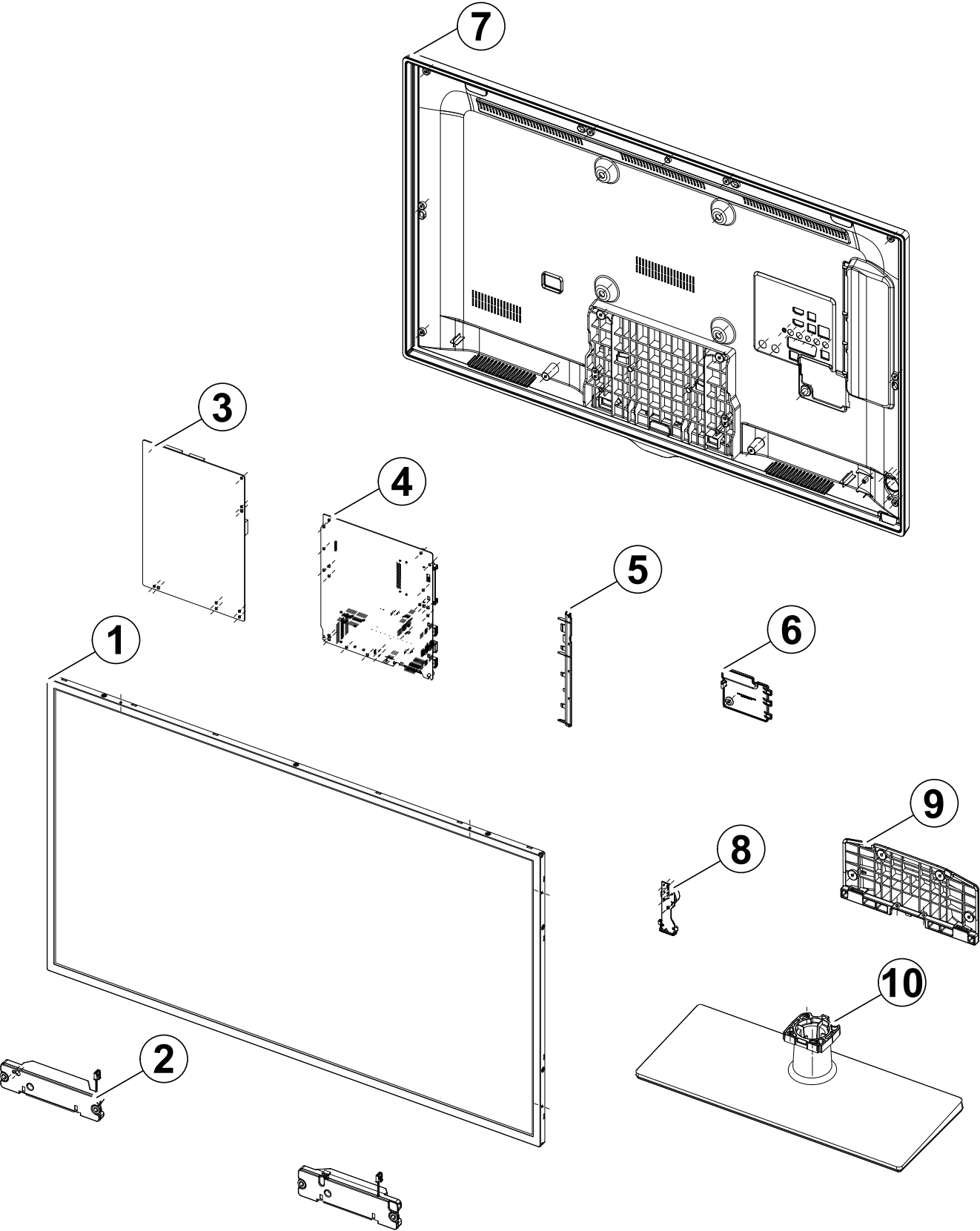

Parts List

No.	Parent	Lvl.	Loc.	Material Code	Description & Specification	SNA	Qty.
1	BN91-09225A	2	PANEL	BN07-01144A	LCD-PANEL; LE370BGA-C1,CEL5BA1,10 bits,37	SA	1
2	BN91-07061D	2	SP01A	BN96-21666C	ASSY SPEAKER P; 6ohm,4pin,10W,Enclosure t	SA	1
3	BN91-07061D	2		BN44-00527A	DC VSS-LED TV PD BD; PD37A1_CPN,PD37A1_CP	SA	1
4	BN91-08830J	2	M0014	BN94-05562J	ASSY PCB MAIN; UE37ES5700SX*	SA	1
5	BN91-07061D	2		BN61-08037A	HOLDER-SIDE AV; UE6100,ABS,HB,EO,Edge LED	SNA	1
6	BN91-07061D	2	FC05	BN63-09152A	COVER-JACK; UE6100,ABS+PMMA,BLACK	SNA	1
7	BN90-03568E	2	M001A	BN96-22225A	ASSY COVER P-MIDDLE; UE5500 37,PC(Clear)+	SA	1
8	BN96-22225A	3		BN96-22457P	ASSY BOARD P-5WAY SWITCH FUNCTION; UE40ES	SA	1
9	BN90-03975B	2	SG03	BN61-07057A	GUIDE-STAND; UD5000 37,PC+G/F 20%,V2,BK00	SA	1
10	BN90-03975B	2	SB04A	BN96-22227B	ASSY STAND P-BASE; UE5500 37~40,PC+ABS,V0	SA	1

2. Electrical Parts List

Level	Loc.	Part Code	Description & Specification	Qty.	SA/SNA
			UE37ES5700SXZG (AP01)		
1		BN90-03568E	ASSY COVER MIDDLE;UE6100 37	1	SNA
.2		6001-002755	SCREW-MACHINE;BH,+,M3,L6,ZPC(BLK),SWRCH1	14	SA
.2	M001A	BN96-22225A	ASSY COVER P-MIDDLE;UE5500 37,PC(Clear)+	1	SA
..3	M0081	6003-000115	SCREW-TAPTYPE;BH,+,B,M3,L6,ZPC(BLK),SWRC	2	SNA
..3		BN02-00112A	TAPE ETC-ALL;POLYESTER,L65.8M,T0.009,W10	0	SNA
..3		BN63-07229G	COVER-SHEET;rose70",urethane,T0.052,W15m	3	SNA
..3		BN63-09195A	COVER-MIDDLE,REAR;UE5500,37,PC(Clear)+PC	1	SNA
..4		0103-007268	RESIN-PC;TN-1045M,70784,TP0010,0.8, 3.0	450	SNA
..4		0103-007678	RESIN-PC ABS;CF210M,6209G,BK0007,V-2	1.5	910
..3	T0071	BN64-01950A	INLAY-TERMINAL;UE4000-19",PS SHEET,EO(24	1	SNA
..3		BN68-03937A	LABEL-TERMINAL SIDE;UE6100,PET,T0.05,Edg	1	SNA
..3		BN81-01805C	A/S-TAPE-FILAMENT;ELMATIT,T0.1,W12,L1200	0	SNA
..3		BN96-22457P	ASSY BOARD P-5WAY SWITCH FUNCTION;UE40ES	1	SA
1	S001A	BN90-03975B	ASSY STAND;UE5500 40	1	SNA
.2	SG03	BN61-07057A	GUIDE-STAND;UD5000 37,PC+G/F 20%,V2,BK00	1	SA
..3		0103-007285	RESIN-PC;MW32020GFU,K032202GFV,BK0007,V2	230	SNA
.2	SB04A	BN96-22227B	ASSY STAND P-BASE;UE5500 37~40,PC+ABS,V0	1	SA
..3	M0081	6003-001239	SCREW-TAPTYPE;FH,+,B,M4,L10,ZPC(WHT),SWR	4	SA
..3	SCREW	6003-001785	SCREW-TAPTYPE;FH,+,B,M4,L8,ZPC(BLK),SWRC	6	SA
..3	SG01	BN61-08178A	GUIDE-STAND NECK;UE5500,37"/40",PC+G/F20	1	SNA
..4		0103-007285	RESIN-PC;MW32020GFU,K032202GFV,BK0007,V2	300	SNA
..3		BN61-08183A	BRACKET-STAND BOTTOM;UE5500,37"/40",HGI,	1	SNA
..3	CCM1	BN63-02183D	COVER-SHEET;RhcM,PE Vinyl,T0.05,680mm,20	1	SNA
..3		BN63-09405B	COVER-STAND BASE;UE5500,37/40,PC+ABS,V0,	1	SNA
..4		0103-005041	RESIN-PC;FR3200TV,901408,BK0008,1.2mm V-	585	SNA
..3		BN67-00327D	RUBBER-FOOT;STAND,SILICON,13*13,T2,GRAY(6	SNA
1		BN91-07061D	ASSY SHIELD;UE37ES5500WX*	1	SNA
.2		6001-002756	SCREW-MACHINE;BH,+,M3,L6,ZPC(WHT),SWRCH1	12	SA
.2	SCREW	6003-001782	SCREW-TAPTYPE;BH,+,B,M4,L12,ZPC(BLK),SWR	1	SA
.2	EC13	BN39-01652J	LEAD CONNECTOR;UE37ES5500,Flat Connector	1	SA
.2		BN44-00527A	DC VSS-LED TV PD BD;PD37A1_CPN,PD37A1_CP	1	SA
.2		BN61-08037A	HOLDER-SIDE AV;UE6100,ABS,HB,EO,Edge LED	1	SNA
..3		0103-004609	RESIN-ABS;HF-0680U,K21294,BK0007,1.5mm H	13	SNA
.2	FC05	BN63-09152A	COVER-JACK;UE6100,ABS+PMMA,BLACK	1	SNA
..3		0103-005096	RESIN-ABS;HAM 8560,98055,2.0mm HB	14	SNA
.2		BN81-01805D	A/S-TAPE-FILAMENT;ELMATIT,T0.1,W30,L1200	0	SNA
.2	SP01A	BN96-21666C	ASSY SPEAKER P;6ohm,4pin,10W,Enclosure t	1	SA

Exploded Views and Parts List

Level	Loc.	Part Code	Description & Specification	Qty.	SA/SNA
.2	FL06	BN96-22239S	ASSY CABLE P-FFC;UE37ES5500,FFC,347mm,51	1	SA
1	M0017	BN91-08830J	ASSY CHASSIS;UE37ES5700SX*	1	SNA
.2	M0014	BN94-05562J	ASSY PCB MAIN;UE37ES5700SX*	1	SA
...3		BN97-05394L	ASSY SMD;UE5N, E5700,SWEDEN	1	SNA
...4		0202-001477	SOLDER-CREAM;LST309-M,D20~45um,96.5Sn/3A	5	SNA
...4	DS01A	0401-001056	DIODE-SWITCHING;MMBD4148SE,100V,200mA,SO	2	SA
...4		0403-001783	DIODE-ZENER;BZB84-C6V2,5.8/6.6V,300mW,SO	3	SNA
...4	D0254	0404-001271	DIODE-SCHOTTKY;SSA34,40V,3000mA,SMA,TP	3	SA
...4	D0254	0404-001404	DIODE-SCHOTTKY;BAT721C,40V,200mA,SOT-23,	2	SA
...4	T0139	0406-001200	DIODE-TVS;RCLAMP0504F,6/-V,150W,SC-70	1	SA
...4	T0139	0406-001271	DIODE-TVS;RCLAMP0524P,6/-V,150W,SLP251	1	SNA
...4		0406-001290	DIODE-TVS;3.0SMCJ20A,22.2/-/24.5V,3000W,	1	SNA
...4	KQ1	0501-000279	TR-SMALL SIGNAL;KSA1182-Y,PNP,150mW,SOT-	1	SA
...4	Q101	0501-000445	TR-SMALL SIGNAL;KTC3875S-Y,NPN,150mW,SOT	2	SC
...4	CEQ2	0505-000110	FET-SILICON;2N7002,N,60V,115mA,7.5ohm,0.	4	SA
...4		0505-002598	FET-SILICON;AP2317GN,P,-20V,-4.2A,0.052o	1	SA
...4	IC104	0801-002630	IC-CMOS LOGIC;74AHCT1G08,2-INPUT AND GAT	1	SA
...4	ND51C2	0801-002780	IC-CMOS LOGIC;74LVC1G17,SCHMITT-TRIGGER	1	SA
...4	IC104	0801-003330	IC-CMOS LOGIC;Octal buffer,DQFN,20P,4.5x	2	SA
...4	IC104	0802-001012	IC-CMOS LOGIC;74LCX245,TRANSCEIVER,DQFN,	1	SNA
...4		0904-002714	IC-USC;QFN,28P,5.0mm X 5.0mm,12MHz,TP,PL	1	SA
...4	IC112	1103-001310	IC-EEPROM;24LC02B,2Kbit,256x8,SOIC,8P,5x	4	SA
...4		1103-001487	IC-EEPROM;AT24C256C-SSHL-T,256Kbit,32Kx8	1	SA
...4		1105-002253	IC-DDR3 SDRAM;K4B2G1646C-HCK0,DDR3 SDRAM	3	SA
...4		1201-003183	IC-AUDIO AMP;DRV612,HTSSOP,14P,5x4.4mm,D	1	SA
...4		1201-003333	IC-POWER AMP;NTP-7412S,MLF,48P,7x7mm,DUA	1	SNA
...4		1203-004364	IC-VOL. DETECTOR;RT9818C-42PV,SOT-23,3P,	1	SA
...4		1203-006017	IC-VOL. DETECTOR;RT9824GJ8,TSOT23,8P,2.9	1	SA
...4	T0087	1203-006109	IC-POSI.FIXED REG.;S-1206B33-M3T1G,SOT-2	1	SA
...4	T0087	1203-006130	IC-POSI.FIXED REG.;S-1172B25-U5T1G,SOT-8	1	SA
...4	T0087	1203-006135	IC-POSI.FIXED REG.;AP1117D-33-GZ-13-89,T	1	SA
...4	T0087	1203-006136	IC-POSI.FIXED REG.;AP1117D-18-GZ-13-89,T	1	SA
...4	IC012	1203-006138	IC-POSI.ADJUST REG.;AP1117DGZ-13-89,TO-2	1	SA
...4		1203-006683	IC-DC/DC CONVERTER;A8294SESTR-T,QFN,20P,	1	SNA
...4		1203-007080	IC-DC/DC CONVERTER;AOZ1051PI,SO-8,8P,4.9	1	SA
...4		1203-007211	IC-POSI.FIXED REG.;G9915-12T45U,TO-252,3	1	SNA
...4		1203-007238	IC-PWM CONTROLLER;TPS54427,DDA,8P,4.8x3.	2	SNA
...4		1203-007242	IC-POSI.ADJUST REG.;G2992BP11U,SOP-8,8P,	1	SA
...4		1203-007249	IC-SWITCH CUR. REG.;TPS62561DDC,DDA,5P,3	1	SA
...4		1204-003351	IC-DECODER;SEMS27,PBGA,717P,23x23mm,PLAS	1	SNA

Level	Loc.	Part Code	Description & Specification	Qty.	SA/SNA
...4		1205-003733	IC-SWITCH;AP2191MPG-13,MSOP-8L-EP,8P,2.9	1	SA
...4		1205-004155	IC-SWITCH;AOZ1360AIL,SO-8,8P,4.9X3.9mm,P	1	SA
...4		1205-004447	IC-SWITCH;TPS2051CDBVR,SOT23-5,5P,3x1.65	1	SA
...4		1405-001271	VARISTOR;35V,20Vdc,5A,1.0x0.5x0.6mm,TP,1	24	SA
...4	MR604	2007-000137	R-CHIP;2Kohm,5%,1/16W,TP,1005	11	SNA
...4	R105	2007-000138	R-CHIP;100ohm,5%,1/16W,TP,1005	16	SA
...4	AR49	2007-000140	R-CHIP;1Kohm,5%,1/16W,TP,1005	7	SNA
...4	AVR73	2007-000142	R-CHIP;2.7Kohm,5%,1/16W,TP,1005	1	SA
...4	R319	2007-000143	R-CHIP;4.7Kohm,5%,1/16W,TP,1005	28	SNA
...4	R104	2007-000148	R-CHIP;10Kohm,5%,1/16W,TP,1005	37	SA
...4	MR36	2007-000153	R-CHIP;22Kohm,5%,1/16W,TP,1005	4	SNA
...4	AR43	2007-000155	R-CHIP;27Kohm,5%,1/16W,TP,1005	1	SNA
...4	MR13	2007-000157	R-CHIP;47Kohm,5%,1/16W,TP,1005	15	SNA
...4	R509	2007-000170	R-CHIP;1Mohm,5%,1/16W,TP,1005	1	SNA
...4	R111	2007-000171	R-CHIP;0ohm,5%,1/16W,TP,1005	11	SNA
...4	HDR17	2007-000172	R-CHIP;10ohm,5%,1/16W,TP,1005	3	SNA
...4	R338	2007-000173	R-CHIP;22ohm,5%,1/16W,TP,1005	7	SNA
...4	UR23	2007-000174	R-CHIP;47ohm,5%,1/16W,TP,1005	2	SNA
...4		2007-000336	R-CHIP;120Kohm,1%,1/10W,TP,1608	1	SA
...4	PR6	2007-000583	R-CHIP;22Kohm,1%,1/10W,TP,1608	1	SA
...4	R726	2007-000695	R-CHIP;3.3ohm,5%,1/10W,TP,1608	4	SNA
...4	R124	2007-000775	R-CHIP;33Kohm,5%,1/16W,TP,1005	1	SNA
...4	R2007	2007-000803	R-CHIP;36Kohm,1%,1/10W,TP,1608	1	SA
...4		2007-000816	R-CHIP;390Kohm,1%,1/10W,TP,1608	1	SNA
...4	DR6	2007-000831	R-CHIP;39Kohm,5%,1/16W,TP,1005	1	SA
...4	DR37	2007-000932	R-CHIP;470ohm,5%,1/16W,TP,1005	1	SNA
...4	VR88	2007-001116	R-CHIP;680ohm,1%,1/10W,TP,1608	1	SA
...4	S1G0843	2007-001125	R-CHIP;68Kohm,1%,1/10W,TP,1608	1	SA
...4		2007-001168	R-CHIP;75ohm,5%,1/4W,TP,3216	1	SA
...4	OTR1	2007-001292	R-CHIP;33ohm,5%,1/16W,TP,1005	13	SNA
...4	DR43	2007-001298	R-CHIP;51ohm,5%,1/16W,TP,1005	2	SNA
...4	DR1	2007-001301	R-CHIP;68ohm,5%,1/16W,TP,1005	7	SA
...4	R16	2007-001313	R-CHIP;330ohm,5%,1/16W,TP,1005	2	SNA
...4	R326	2007-001325	R-CHIP;3.3Kohm,5%,1/16W,TP,1005	1	SNA
...4	PR24	2007-002970	R-CHIP;56ohm,5%,1/16W,TP,1005	4	SA
...4		2007-003022	R-CHIP;62ohm,5%,1/16W,TP,1005	26	SNA
...4	HDR8	2007-007095	R-CHIP;390ohm,5%,1/16W,TP,1005	1	SA
...4	R365	2007-007107	R-CHIP;100Kohm,1%,1/16W,TP,1005	3	SNA
...4		2007-007132	R-CHIP;15Kohm,1%,1/16W,TP,1005	1	SA
...4		2007-007135	R-CHIP;18Kohm,1%,1/16W,TP,1005	6	SNA

Exploded Views and Parts List

Level	Loc.	Part Code	Description & Specification	Qty.	SA/SNA
...4		2007-007138	R-CHIP;27Kohm,1%,1/16W,TP,1005	1	SA
...4		2007-007139	R-CHIP;47Kohm,1%,1/16W,TP,1005	1	SA
...4		2007-007156	R-CHIP;1ohm,5%,1/16W,TP,1005	4	SNA
...4		2007-007311	R-CHIP;22Kohm,1%,1/16W,TP,1005	1	SA
...4		2007-007313	R-CHIP;6.8Kohm,1%,1/16W,TP,1005	1	SA
...4		2007-007318	R-CHIP;1Kohm,1%,1/16W,TP,1005	15	SNA
...4		2007-007463	R-CHIP;1.1Kohm,1%,1/16W,TP,1005	1	SA
...4		2007-007517	R-CHIP;240ohm,1%,1/16W,TP,1005	3	SNA
...4		2007-007538	R-CHIP;56Kohm,1%,1/16W,TP,1005	1	SA
...4		2007-007698	R-CHIP;5.1Kohm,1%,1/16W,TP,1005	1	SNA
...4	MR11	2007-008015	R-CHIP;75ohm,1%,1/16W,TP,1005	8	SA
...4		2007-008142	R-CHIP;511Kohm,1%,1/10W,TP,1608	1	SA
...4		2007-008275	R-CHIP;30Kohm,1%,1/16W,TP,1005	1	SNA
...4		2007-008298	R-CHIP;49.9ohm,1%,1/16W,TP,1005	4	SA
...4		2007-008649	R-CHIP;220ohm,1%,1/16W,TP,1005	1	SNA
...4	ZRN10	2011-001261	R-NETWORK;33ohm,5%,1/16W,L,CHIP,8P,TP,2.	2	SA
...4	DAR09	2011-001262	R-NETWORK;22ohm,5%,1/16W,L,CHIP,8P,TP,2.	3	SA
...4	HRP2	2011-001344	R-NETWORK;100ohm,5%,1/16W,L,CHIP,8P,TP,2	2	SA
...4	DRP29	2011-001396	R-NETWORK;4.7Kohm,5%,1/16W,L,CHIP,8P,TP,	1	SA
...4		2011-001449	R-NETWORK;22ohm,5%,1/16W,L,4P,TP,1010	6	SA
...4		2011-001506	R-NETWORK;10Kohm,5%,1/16W,L,CHIP,4P,TP,1	7	SNA
...4		2011-001519	R-NETWORK;33OHM,5%,1/16W,L,CHIP,4P,TP,1.	1	SA
...4		2011-001527	R-NETWORK;4.7Kohm,5%,1/16W,L,CHIP,4P,TP,	3	SNA
...4		2011-001587	R-NETWORK;100ohm,5%,1/16W,L,CHIP-V,4P,TP	6	SNA
...4	PC43	2203-000233	C-CER,CHIP;0.1nF,5%,50V,C0G,TP,1005	7	SA
...4	MC9	2203-000359	C-CER,CHIP;0.15nF,5%,50V,C0G,TP,1005,0.5	1	SA
...4	DC1	2203-000386	C-CER,CHIP;0.015nF,5%,50V,C0G,TP,1005	2	SA
...4	C254	2203-000438	C-CER,CHIP;1nF,10%,50V,X7R,TP,1005	8	SA
...4	C507	2203-000489	C-CER,CHIP;2.2nF,10%,50V,X7R,TP,1005	5	SA
...4	AD480	2203-000530	C-CER,CHIP;2.7nF,10%,50V,X7R,TP,1005,-	2	SNA
...4	V1233	2203-000575	C-CER,CHIP;220nF,10%,25V,X7R,TP,2012	5	SNA
...4	AD480	2203-000679	C-CER,CHIP;0.027nF,5%,50V,C0G,TP,1005	5	SNA
...4	AD480	2203-000714	C-CER,CHIP;3.3nF,10%,50V,X7R,TP,1005	4	SA
...4	DC25	2203-000812	C-CER,CHIP;0.033nF,5%,50V,C0G,TP,1005	4	SA
...4	AD480	2203-000995	C-CER,CHIP;0.047nF,5%,50V,C0G,TP,1005	3	SA
...4	AD480	2203-002285	C-CER,CHIP;10nF,10%,50V,X7R,TP,1005	20	SNA
...4	AD480	2203-002525	C-CER,CHIP;0.56nF,10%,50V,X7R,TP,1005	6	SNA
...4	AC2	2203-002711	C-CER,CHIP;100nF,10%,25V,X7R,TP,1608	6	SA
...4	AAC1	2203-005249	C-CER,CHIP;100nF,10%,50V,X7R,TP,1608	12	SNA
...4	AD480	2203-005344	C-CER,CHIP;22nF,10%,25V,X7R,TP,1005,0.5T	1	SNA

Level	Loc.	Part Code	Description & Specification	Qty.	SA/SNA
...4	VC37	2203-006048	C-CER,CHIP;100nF,10%,10V,X7R,TP,1005	109	SA
...4	AD480	2203-006126	C-CER,CHIP;47nF,10%,16V,X7R,TP,1005	16	SNA
...4	JC10	2203-006324	C-CER,CHIP;2200nF,10%,10V,X5R,TP,1608	8	SA
...4	C802	2203-006348	C-CER,CHIP;1000nF,10%,25V,X5R,TP,1608,0.	5	SA
...4	C125	2203-006361	C-CER,CHIP;10000nF,10%,10V,X5R,TP,2012	26	SC
...4	HE4	2203-006474	C-CER,CHIP;22000nF,20%,6.3V,X5R,TP,2012	13	SA
...4	HDC11	2203-006562	C-CER,CHIP;1000nF,10%,10V,X5R,TP,1005	19	SNA
...4	AD480	2203-006824	C-CER,CHIP;4700nF,10%,10V,X5R,TP,1608,-	4	SNA
...4	C23	2203-006890	C-CER,CHIP;10000nF,20%,6.3V,X5R,TP,1608	26	SA
...4	AD480	2203-006992	C-CER,CHIP;0.33nF,5%,50V,COG,TP,1005	2	SNA
...4	AD480	2203-007176	C-CER,CHIP;10000nF,10%,16V,X5R,TP,2012,1	5	SNA
...4	AD480	2203-007486	C-CER,CHIP;1000nF,10%,50V,X5R,TP,1608	1	SNA
...4		2402-001403	C-AL,SMD;100uF,20%,35V,TP,10.3X10.3	2	SNA
...4	T0052	2703-000158	INDUCTOR-SMD;1uH,10%,2012,.4ohm,50mA,45,	2	SA
...4	S1Q036	2703-000408	INDUCTOR-SMD;3.3uH,20%,3225,.28ohm,500mA	1	SA
...4		2703-003343	INDUCTOR-SMD;2.2uH,20%,2520,0.104ohm,130	1	SNA
...4	T0052	2703-003713	INDUCTOR-SMD;1.5uH,20%,7366,0.015ohm,700	2	SA
...4	T0052	2703-003790	INDUCTOR-SMD;4.7uH,20%,8080,0.025ohm,450	1	SA
...4		2703-003879	INDUCTOR-SMD;33uH,20%,10.0mmX10.0mm,0.12	1	SA
...4		2703-003930	INDUCTOR-SMD;4.7uH,20%,5050,0.067ohm,230	4	SA
...4	X202	2801-003326	CRYSTAL-SMD;24MHz,30ppm,28-ABX,20pF,50oh	1	SA
...4	X202	2801-003948	CRYSTAL-SMD;12MHz,30ppm,28-AAN,12pF,60oh	1	SA
...4	X202	2801-004775	CRYSTAL-SMD;12MHz,30ppm,16pF,30ohm,TP	1	SNA
...4	DR32	3301-000314	BEAD-SMD;120ohm,1608,TP,120ohm/100MHz	6	SNA
...4	T0568	3301-002039	BEAD-SMD;26ohm,1608,TP	30	SA
...4	F201	3601-001374	FUSE-SURFACE MOUNT;32V,5A,FAST-ACTING,PL	1	SA
...4		3701-001762	CONNECTOR-HDMI;19P,2ROW,FEMALE,SMD-A,AU	1	SA
...4		3701-001784	CONNECTOR-HDMI;19P,2ROW,FEMALE,SMD-S,AU	2	SA
...4		3707-001106	CONNECTOR-OPTICAL;STRAIGHT W/L,SPDIF	1	SA
...4		3709-001712	CONNECTOR-CARD SLOT;68P,1.27mm,ANGLE,AU,	1	SA
...4	HB01A	3711-005925	HEADER-BOARD TO CABLE;BOX,51P,1R,0.5mm,S	1	SA
...4		3711-007571	CONNECTOR-HEADER;BOX,18P,2R,2.0mm,ANGLE,	1	SA
...4	EH01	3711-007742	HEADER-BOARD TO CABLE;BOX,20P,2R,2mm,ANG	1	SA
...4	EH01	3711-008131	HEADER-BOARD TO CABLE;BOX,4P,1R,2.5mm,AN	1	SA
...4		3722-003213	JACK-PIN;J/B 5P + Screw hole,NI+SN,BLK,S	1	SA
...4		3722-003225	JACK-USB;4P/1C,Au,BLK,SMD-A(DIP),A	2	SA
...4		3722-003226	JACK-PHONE;7P/1C,SN,BLK	3	SA
...4		3722-003229	JACK-MODULAR;8P/8C W/L,Y,STRAIGHT,N,Au,1	1	SA
...4		3722-003408	JACK-SCART;21P,SN,BLK	1	SA
...4	ET01	BN40-00235A	TUNER;DNSD243VL144A,DNSD243VL144A,DVB-TC	1	SA

Exploded Views and Parts List

Level	Loc.	Part Code	Description & Specification	Qty.	SA/SNA
...4		BN41-01812A	PCB MAIN;X10 PLUS, LED 6 Series,FR-4,4,A	1	SNA
...4		BN97-06569A	ASSY MICOM-MAIN;T-MST10PDEUC-XXXX,U78A,	1	SNA
....5		1107-002088	IC-NAND FLASH;KLM2G1HE3F-B001,2GByte,16G	1	SNA
...4		BN97-06570A	ASSY MICOM-SUB;T-MST10PDEUC-S-XXXX,U78A,	1	SNA
....5		0903-001718	IC-MICROCONTROLLER;61P805-RG480WT,LQFP,4	1	SNA
...3		BN97-06719A	ASSY DRM-KEY;X9/X10+	1	SNA
...4		BN46-00109H	KEY CODE-CERTIFI;MAC,TV/AV,General	1	SNA
...4		BN46-00110G	KEY CODE-CERTIFI;HDCP,TV,MSTAR,General	1	SNA
...4		BN46-00115H	KEY CODE-CERTIFI;CI+,TV,2012X,Euro	1	SNA
...3	T0066	BP62-00017A	HEAT SINK-ES;SP-50L2HX,A6063S,T2.0,26.2,	1	SNA
1		BN91-09225A	ASSY LCD-AUO;BN07-01144A	1	SNA
.2	PANEL	BN07-01144A	LCD-PANEL;LE370BGA-C1,CEL5BA1,10 bits,37	1	SA
1		BN92-08215A	ASSY LABEL;UE5N, E5500	1	SNA
.2		BN68-04168A	LABEL-01,TV POP;5500,American,PET,T0.1,1	1	SNA
.2	T0527	BP68-00052B	LABEL-00,RATING;FPTV,PET,T0.05,93,73	1	SNA
1		BN92-08942B	ASSY P/MATERIAL;UE6100 37	1	SNA
.2		6902-001675	BAG ROLL;HDPE/NITRON,T0.3,W700,L450M,TRP	2	SNA
.2	M040	6922-000013	BAND PP;PP,W18,L2300/L2900,TRP	1	SNA
.2		BH69-40383L	PACKING INNER-00,PAD;COMM,CB,1200,900,YE	1	SNA
.2		BN01-00043A	FOIL-STRETCH-HOOD;LLDPE,T0.08,W980,L1400	0	SNA
.2		BN63-09367A	COVER-SHEET NITRON;UE40D5003,PE,T2.0,130	1	SNA
.2		BN69-06794B	PALLET-WOODEN;WOOD,1090,1300,130,18%	1	SNA
.2		BN69-07145A	CUSHION-SET;UE5500 37",EPS,16.7g/l	1	SNA
.2		BN74-00008D	TAPE-OPP MASKING;OPP,T0.05,W75,L800M,CLR	2	SNA
1		BN92-09852G	ASSY BOX;UE6100 37	1	SNA
.2		BH68-00662A	LABEL BOX-00;ALL MODEL,MOJO 90G,60,110,W	1	SNA
.2		BN69-07557D	BOX-SET;37UE5700-SS,CB,A-01,SW2,YEL,W106	1	SNA
1	ACCE1	BN92-10429V	ASSY ACCESSORY;UE37ES5700SXZG	1	SNA
.2		BN68-04098B	LABEL-STICKER;UE5N,EDC,PET,T0.05,60,120,	1	SNA
.2	ACCE2	BN96-18550N	ASSY ACCESSORY-CABLE;UE5N, E5500,EUROPE	1	SNA
...3	T0268	3903-000603	CBF-POWER CORD;DT,CEE,LP-21L,250V,2.5A,B	1	SA
...3	T0120	4301-000121	BATTERY-MN;1.5V,R03,10.5x44.5m,HOLDER,7.	2	SNA
...3	SCREW	6003-001782	SCREW-TAPTYPE;BH,+,B,M4,L12,ZPC(BLK),SWR	8	SA
...3	T0524	6902-000110	BAG PE;LDPE,T0.05,W250,L400,TRP,28,2,9.2	1	SNA
...3	T0524	6902-000341	BAG PE;LDPE,T0.05,L90,W70,TRP,,,PE MARK	1	SNA
...3	REMO2	AA59-00582A	REMOCON;TM1250,49Key,3V,Europe, E5700	1	SA
...3	M9889	BN63-01798B	CLOTH-CLEAN;CLOTH,180,200,sea blue,ToC	1	SNA
...3		BN96-15806B	ASSY HOLDER P-WIRE STAND;UE5500,NYLON,BL	1	SNA
...4		BN61-04731D	BOSS-TAPE;AMBER,ACRYL,T1.1,W20.0mm,WHITE	0	SNA
...4		BN61-05491C	HOLDER-WIRE STAND;UE5500,NYLON,BLK	1	SNA

Level	Loc.	Part Code	Description & Specification	Qty.	SA/SNA
..3	EH03A	BN96-18153A	ASSY HOLDER P-RING;11 LED-TV	1	SNA
...4		6902-001404	BAG ZIPPER;LDPE,T0.05,W80,L100,TRP	1	SNA
...4	AH365	BN61-07295A	HOLDER-RING;40UD5500,ABS,BK0007,HB	4	SNA
.2	ACCE4	BN96-23103E	ASSY ACCESSORY-MANUAL;UE32ES5700SXZG,37,	1	SNA
..3		6902-000476	BAG PE;LDPE,T0.03,W250,L350,TRP,Recycle,	1	SNA
..3		BN68-00514K	MANUAL FLYER-01,WARRANTY CARD;comm,Samsu	1	SNA
..3		BN68-03019A	LEAFLET-02,SAFETY GUIDE;ALL,SAMSUNG,28LE	1	SNA
..3		BN68-03943X	LEAFLET-UE5500;ALL,SAMSUNG,ENG,EUROPE,W/	1	SNA
..3		BN68-04027J	MANUAL FLYER-STAND GUIDE;UES5500 32/40/4	1	SNA
..3		BN68-04056C	MANUAL USERS-01;E5700,SAMSUNG,ENG/DEU/FR	1	SNA